



BGA2717

MMIC wideband amplifier

Rev. 3 — 8 September 2011

Product data sheet

1. Product profile

1.1 General description

Silicon Monolithic Microwave Integrated Circuit (MMIC) wideband amplifier with internal matching circuit in a 6-pin SOT363 SMD plastic package.

CAUTION



This device is sensitive to ElectroStatic Discharge (ESD). Therefore care should be taken during transport and handling.

1.2 Features and benefits

- Internally matched to 50 Ω
- Wide frequency range (3.2 GHz at 3 dB bandwidth)
- Flat 24 dB gain (± 1 dB up to 2.8 GHz)
- -2.5 dBm output power at 1 dB compression point
- Good linearity for low current ($IP_{3\text{out}} = 10$ dBm)
- Low second harmonic; -38 dBc at $P_D = -40$ dBm
- Low noise figure; 2.3 dB at 1 GHz
- Unconditionally stable ($K \geq 2$).

1.3 Applications

- LNB IF amplifiers
- Cable systems
- ISM
- General purpose.

1.4 Quick reference data

Table 1. Quick reference data

Symbol	Parameter	Conditions	Min	Typ	Max	Unit
V_S	DC supply voltage		-	5	6	V
I_S	supply current		-	8	-	mA
$ s_{21} ^2$	insertion power gain	$f = 1$ GHz	-	24	-	dB
NF	noise figure	$f = 1$ GHz	-	2.3	-	dB
$P_{L(\text{sat})}$	saturated load power	$f = 1$ GHz	-	1	-	dBm



2. Pinning information

Table 2. Pinning

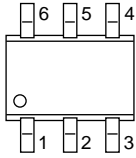
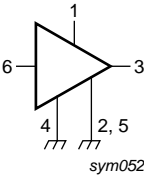
Pin	Description	Simplified outline	Symbol
1	V _S		
2, 5	GND2		
3	RF_OUT		
4	GND1		
6	RF_IN		

3. Ordering information

Table 3. Ordering information

Type number	Package		
	Name	Description	Version
BGA2717	-	plastic surface mounted package; 6 leads	SOT363

4. Marking

Table 4. Marking

Type number	Marking code
BGA2717	1B-

5. Limiting values

Table 5. Limiting values

In accordance with the Absolute Maximum Rating System (IEC 60134).

Symbol	Parameter	Conditions	Min	Max	Unit
V _S	DC supply voltage	RF input AC coupled	-	6	V
I _S	supply current		-	15	mA
P _{tot}	total power dissipation	T _{sp} ≤ 90 °C	-	200	mW
T _{stg}	storage temperature		-65	+150	°C
T _j	junction temperature		-	150	°C
P _D	maximum drive power		-	-10	dBm

6. Thermal characteristics

Table 6. Thermal characteristics

Symbol	Parameter	Conditions	Typ	Unit
$R_{th(j-sp)}$	thermal resistance from junction to solder point	$P_{tot} = 200 \text{ mW}$; $T_{sp} \leq 90 \text{ }^\circ\text{C}$	300	K/W

7. Characteristics

Table 7. Characteristics

$V_S = 5 \text{ V}$; $I_S = 8 \text{ mA}$; $T_j = 25 \text{ }^\circ\text{C}$; measured on demo board; unless otherwise specified.

Symbol	Parameter	Conditions	Min	Typ	Max	Unit
I_S	supply current		6	8	10	mA
$ s_{21} ^2$	insertion power gain	$f = 100 \text{ MHz}$	18	18.6	20	dB
		$f = 1 \text{ GHz}$	23	23.9	25	dB
		$f = 1.8 \text{ GHz}$	24	25	27	dB
		$f = 2.2 \text{ GHz}$	24	25.1	27	dB
		$f = 2.6 \text{ GHz}$	22	24	26	dB
		$f = 3 \text{ GHz}$	20	22.1	24	dB
$ s_{11} ^2$	input return losses	$f = 1 \text{ GHz}$	15	19	-	dB
		$f = 2.2 \text{ GHz}$	8	9.4	-	dB
$ s_{22} ^2$	output return losses	$f = 1 \text{ GHz}$	8	10	-	dB
		$f = 2.2 \text{ GHz}$	5	6.8	-	dB
$ s_{12} ^2$	isolation	$f = 1.6 \text{ GHz}$	54	55	-	dB
		$f = 2.2 \text{ GHz}$	38	39	-	dB
NF	noise figure	$f = 1 \text{ GHz}$	-	2.3	2.5	dB
		$f = 2.2 \text{ GHz}$	-	2.9	3.1	dB
B	bandwidth	at $ s_{21} ^2 - 3 \text{ dB}$ below flat gain at 1 GHz	3	3.2	-	GHz
K	stability factor	$f = 1 \text{ GHz}$	-	13	-	
		$f = 2.2 \text{ GHz}$	-	1.7	-	
$P_{L(sat)}$	saturated load power	$f = 1 \text{ GHz}$	0	1.4	-	dBm
		$f = 2.2 \text{ GHz}$	-1	+0.1	-	dBm
$P_{L(1dB)}$	load power	at 1 dB gain compression; $f = 1 \text{ GHz}$	-4	-2.6	-	dBm
		at 1 dB gain compression; $f = 2.2 \text{ GHz}$	-5	-3.1	-	dBm
IM2	second order intermodulation product	at $P_D = -40 \text{ dBm}$; $f_0 = 1 \text{ GHz}$	36	38	-	dBc
IP3 _{in}	input, third order intercept point	$f = 1 \text{ GHz}$	-15	-13.9	-	dBm
		$f = 2.2 \text{ GHz}$	-20	-18.8	-	dBm
IP3 _{out}	output, third order intercept point	$f = 1 \text{ GHz}$	9	10	-	dBm
		$f = 2.2 \text{ GHz}$	4	6.3	-	dBm

8. Application information

[Figure 1](#) shows a typical application circuit for the BGA2717 MMIC. The device is internally matched to $50\ \Omega$, and therefore does not need any external matching. The value of the input and output DC blocking capacitors C2 and C3 should not be more than 100 pF for applications above 100 MHz. However, when the device is operated below 100 MHz, the capacitor value should be increased.

The 22 nF supply decoupling capacitor C1 should be located as close as possible to the MMIC.

The printed-circuit board (PCB) top ground plane, connected to pins 2, 4 and 5 must be as close as possible to the MMIC, and ideally directly beneath it. When using via holes, use multiple via holes, located as close as possible to the MMIC.

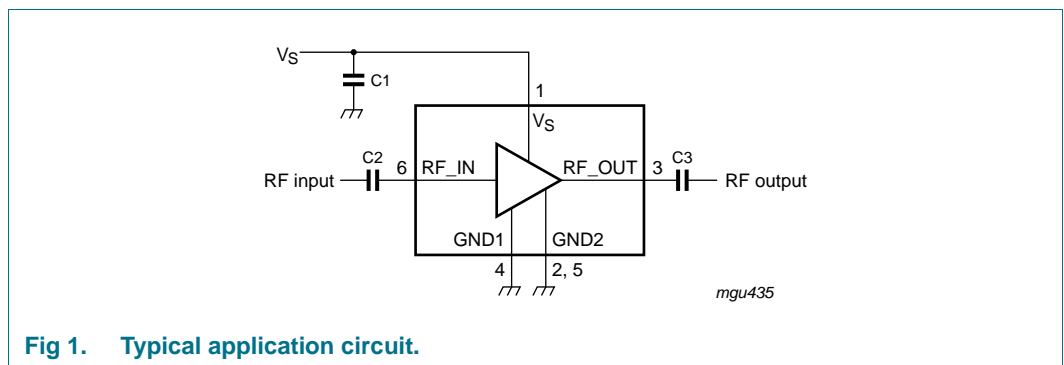
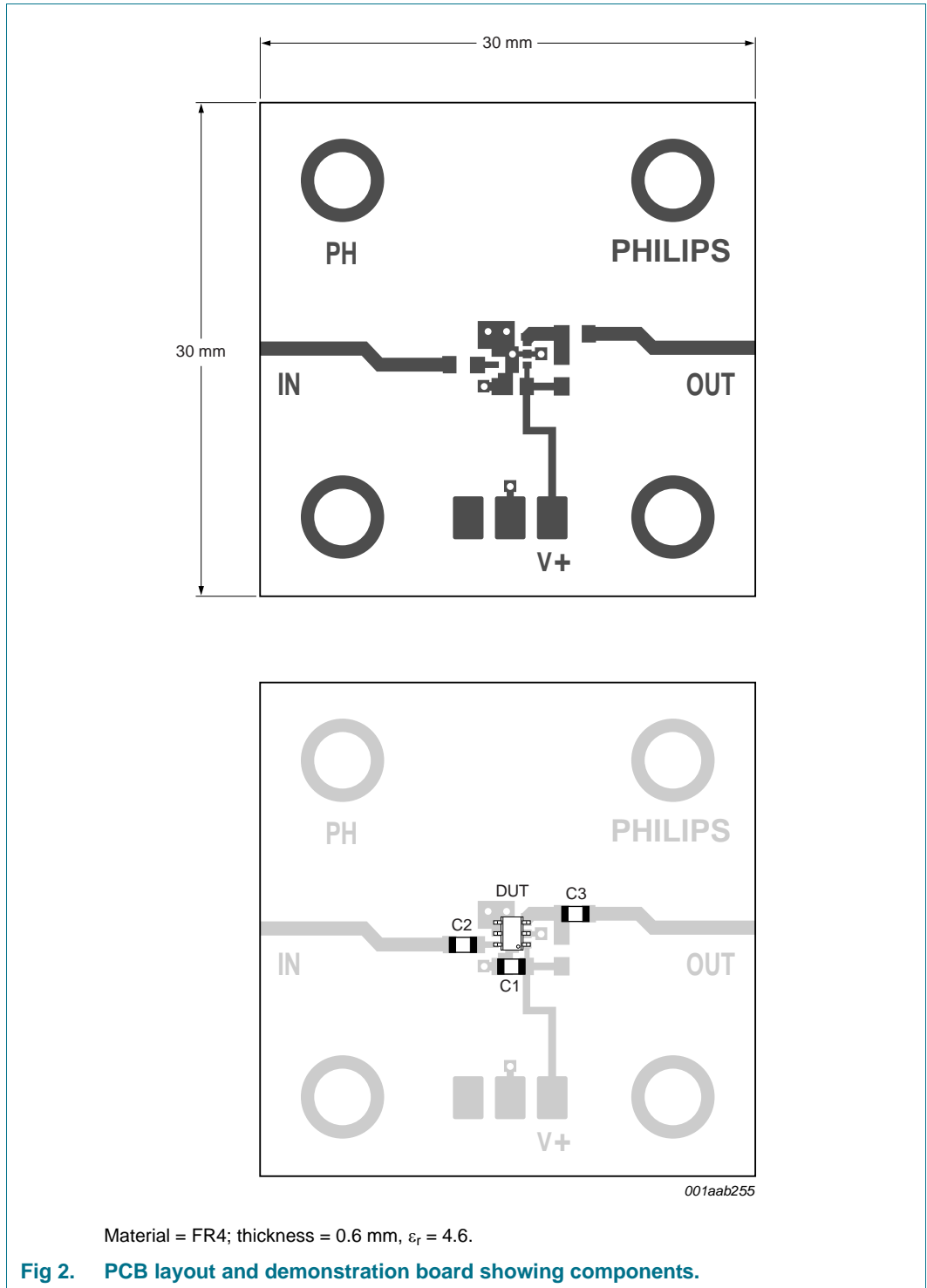

Fig 1. Typical application circuit.

[Figure 2](#) shows the PCB layout, used for the standard demonstration board.



8.1 Grounding and output impedance

If the grounding is not optimal, the gain becomes less flat and the 50 Ω output matching becomes worse. If a better output matching to 50 Ω is required, a 12 Ω resistor (R1) can be placed in series with C3 (see [Figure 3](#)). This will significantly improve the output impedance, at the cost of 1 dB gain and 1 dB output power.

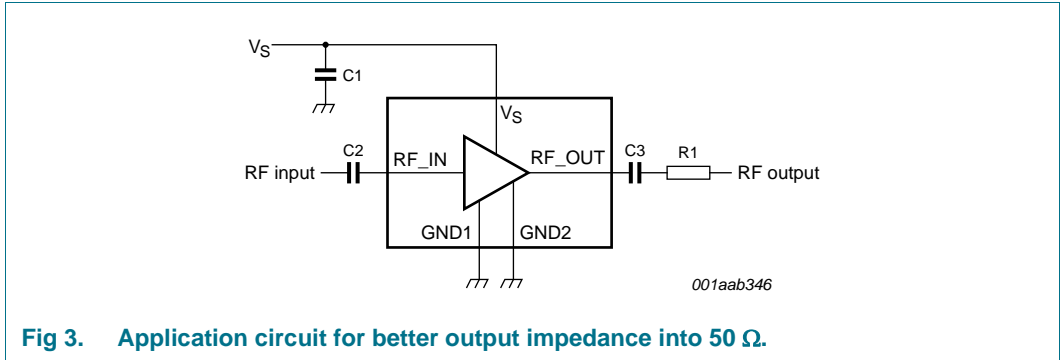

8.2 Application examples

The MMIC is very suitable as IF amplifier in e.g. LNBS. The excellent wideband characteristics make it an ideal building block (see [Figure 4](#)). As second amplifier after an LNA, the MMIC offers an easy matching, low noise solution (see [Figure 5](#)).

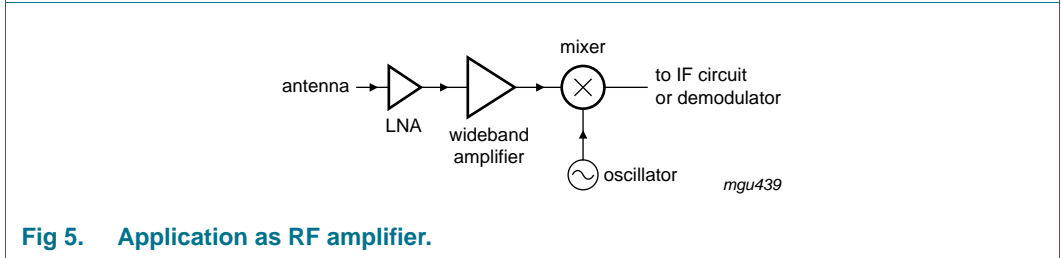
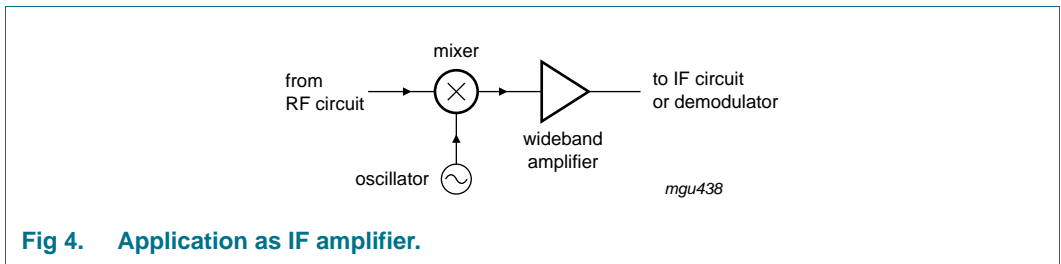

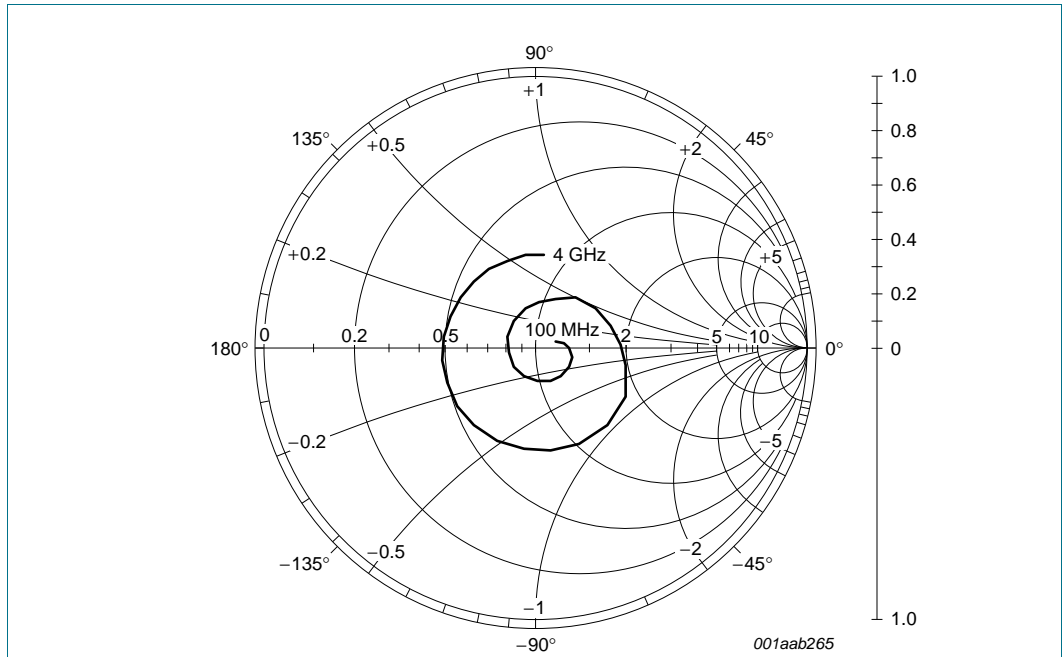

$I_S = 8 \text{ mA}$; $V_S = 5 \text{ V}$; $P_D = -35 \text{ dBm}$; $Z_o = 50 \Omega$.

Fig 6. Input reflection coefficient (s_{11}); typical values.

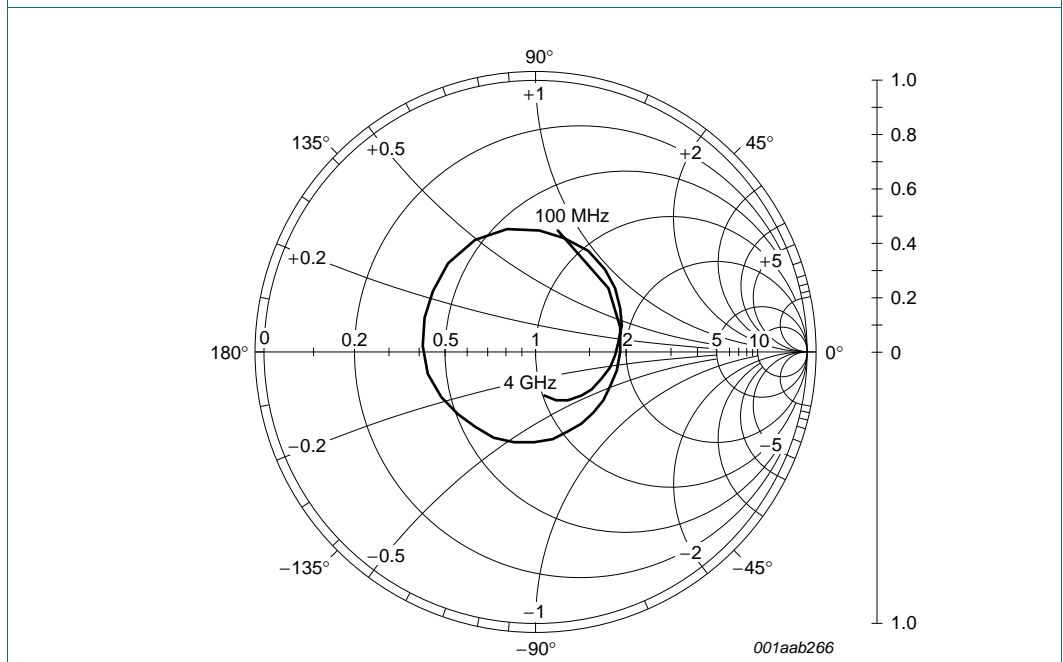

$I_S = 8 \text{ mA}$; $V_S = 5 \text{ V}$; $P_D = -35 \text{ dBm}$; $Z_o = 50 \Omega$.

Fig 7. Output reflection coefficient (s_{22}); typical values.

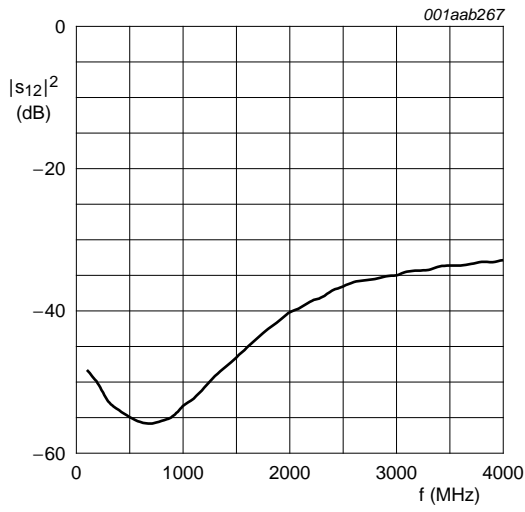

$I_S = 8 \text{ mA}$; $V_S = 5 \text{ V}$; $P_D = -35 \text{ dBm}$; $Z_o = 50 \Omega$.

Fig 8. Isolation ($|s_{12}|^2$) as a function of frequency; typical values.

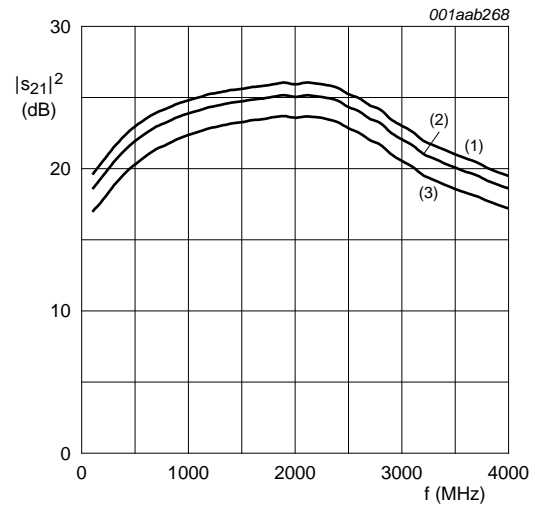

$P_D = -35 \text{ dBm}$; $Z_o = 50 \Omega$.

- (1) $I_S = 8.9 \text{ mA}$; $V_S = 5.5 \text{ V}$.
- (2) $I_S = 8 \text{ mA}$; $V_S = 5 \text{ V}$.
- (3) $I_S = 7.2 \text{ mA}$; $V_S = 4.5 \text{ V}$.

Fig 9. Insertion gain ($|s_{21}|^2$) as a function of frequency; typical values.

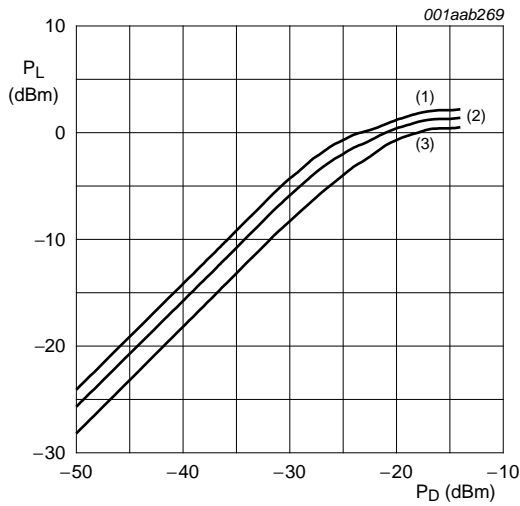

$f = 1 \text{ GHz}$; $Z_o = 50 \Omega$.

- (1) $V_S = 5.5 \text{ V}$.
- (2) $V_S = 5 \text{ V}$.
- (3) $V_S = 4.5 \text{ V}$.

Fig 10. Load power as a function of drive power at 1 GHz; typical values.

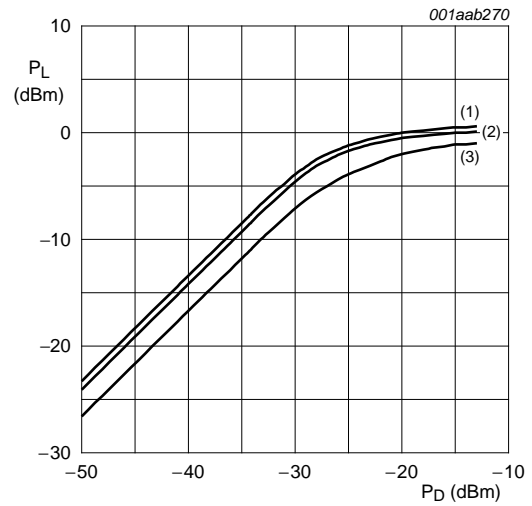

$f = 2.2 \text{ GHz}$; $Z_o = 50 \Omega$.

- (1) $V_S = 5.5 \text{ V}$.
- (2) $V_S = 5 \text{ V}$.
- (3) $V_S = 4.5 \text{ V}$.

Fig 11. Load power as a function of drive power at 2.2 GHz; typical values.

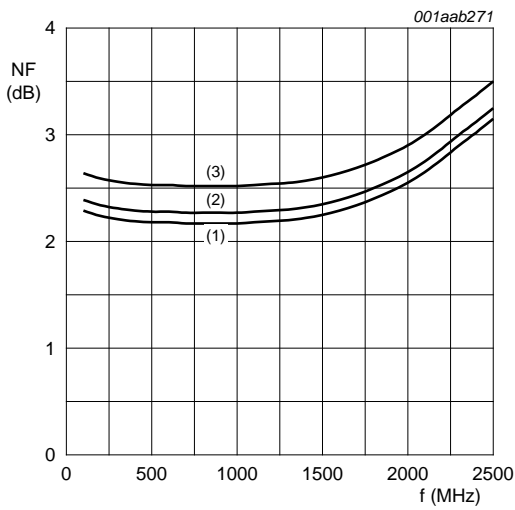

- $Z_o = 50 \Omega$.
- (1) $I_S = 8.9 \text{ mA}$; $V_S = 5.5 \text{ V}$.
 - (2) $I_S = 8 \text{ mA}$; $V_S = 5 \text{ V}$.
 - (3) $I_S = 7.2 \text{ mA}$; $V_S = 4.5 \text{ V}$.

Fig 12. Noise figure as a function of frequency; typical values.

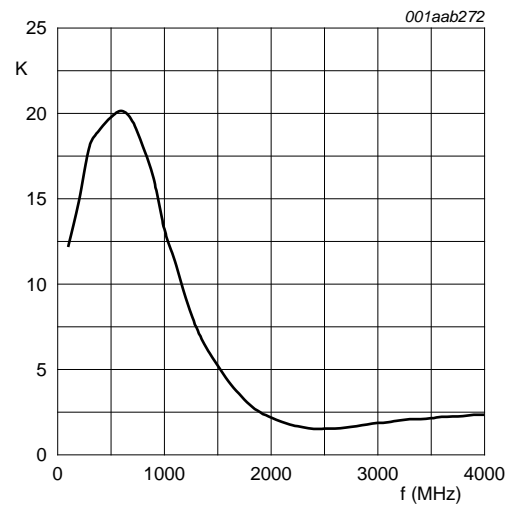

$I_S = 8 \text{ mA}$; $V_S = 5 \text{ V}$; $Z_o = 50 \Omega$.

Fig 13. Stability factor as a function of frequency; typical values.

Table 8. Scattering parameters

$V_S = 5\text{ V}$; $I_S = 8\text{ mA}$; $P_D = -35\text{ dBm}$; $Z_o = 50\ \Omega$; $T_{amb} = 25\text{ }^\circ\text{C}$.

f (MHz)	S ₁₁		S ₂₁		S ₁₂		S ₂₂		K-factor
	Magnitude (ratio)	Angle (deg)	Magnitude (ratio)	Angle (deg)	Magnitude (ratio)	Angle (deg)	Magnitude (ratio)	Angle (deg)	
100	0.074378	13.78537	8.465495	22.90763	0.003859	-66.39435	0.450496	79.88713	12.2
200	0.076338	13.70153	9.420359	7.358555	0.003112	-122.2687	0.354179	40.70919	14.9
400	0.123748	-1.402521	11.56481	-14.92222	0.002011	-40.5142	0.312568	-0.3804	19.1
600	0.145511	-31.32646	13.31271	-37.77988	0.001659	-156.393	0.3038	-25.36808	20.2
800	0.134956	-67.10955	14.56872	-61.08808	0.00169	-164.4454	0.30873	-46.7704	18.1
1000	0.114063	-111.2495	15.61733	-84.67015	0.002146	-174.8593	0.319208	-68.71787	13.2
1200	0.101959	-168.8557	16.45625	-107.9167	0.002901	139.8136	0.335623	-91.58398	9.2
1400	0.125656	129.9717	17.05668	-131.63	0.004053	123.527	0.353582	-116.5485	6.2
1600	0.16736	85.791	17.49643	-155.2301	0.005545	107.0763	0.366893	-140.7537	4.3
1800	0.234721	51.43065	17.90167	-179.6656	0.007498	105.9423	0.404064	-167.9683	2.9
2000	0.285944	16.46701	17.86635	155.5993	0.009779	90.10168	0.42512	163.3173	2.2
2200	0.339673	-11.74152	17.96498	130.5601	0.011736	75.19814	0.459194	135.039	1.7
2400	0.393746	-47.58817	17.32414	103.3297	0.013927	53.10814	0.459988	103.1106	1.5
2600	0.384353	-81.55786	15.87927	77.84766	0.015937	21.70136	0.428158	75.83004	1.5
2800	0.376183	-112.353	14.44081	52.77053	0.016795	4.656224	0.393701	50.16202	1.7
3000	0.358586	-142.5801	12.67831	30.51455	0.01786	-19.19006	0.3497	26.66791	1.9
3200	0.345562	-171.7261	11.27597	10.04765	0.019217	-32.22469	0.30875	6.504047	2.0
3400	0.33312	160.2254	10.43483	-9.842264	0.020551	-49.16136	0.279672	-12.63121	2.1
3600	0.331268	133.8644	9.743293	-30.36495	0.020908	-59.65434	0.248479	-33.64811	2.2
3800	0.337502	108.48	9.072149	-50.7401	0.022136	-78.78085	0.21362	-56.42401	2.3
4000	0.344645	84.75183	8.513716	-71.86536	0.022792	-94.87525	0.168643	-80.24833	2.4

9. Package outline

Plastic surface-mounted package; 6 leads

SOT363

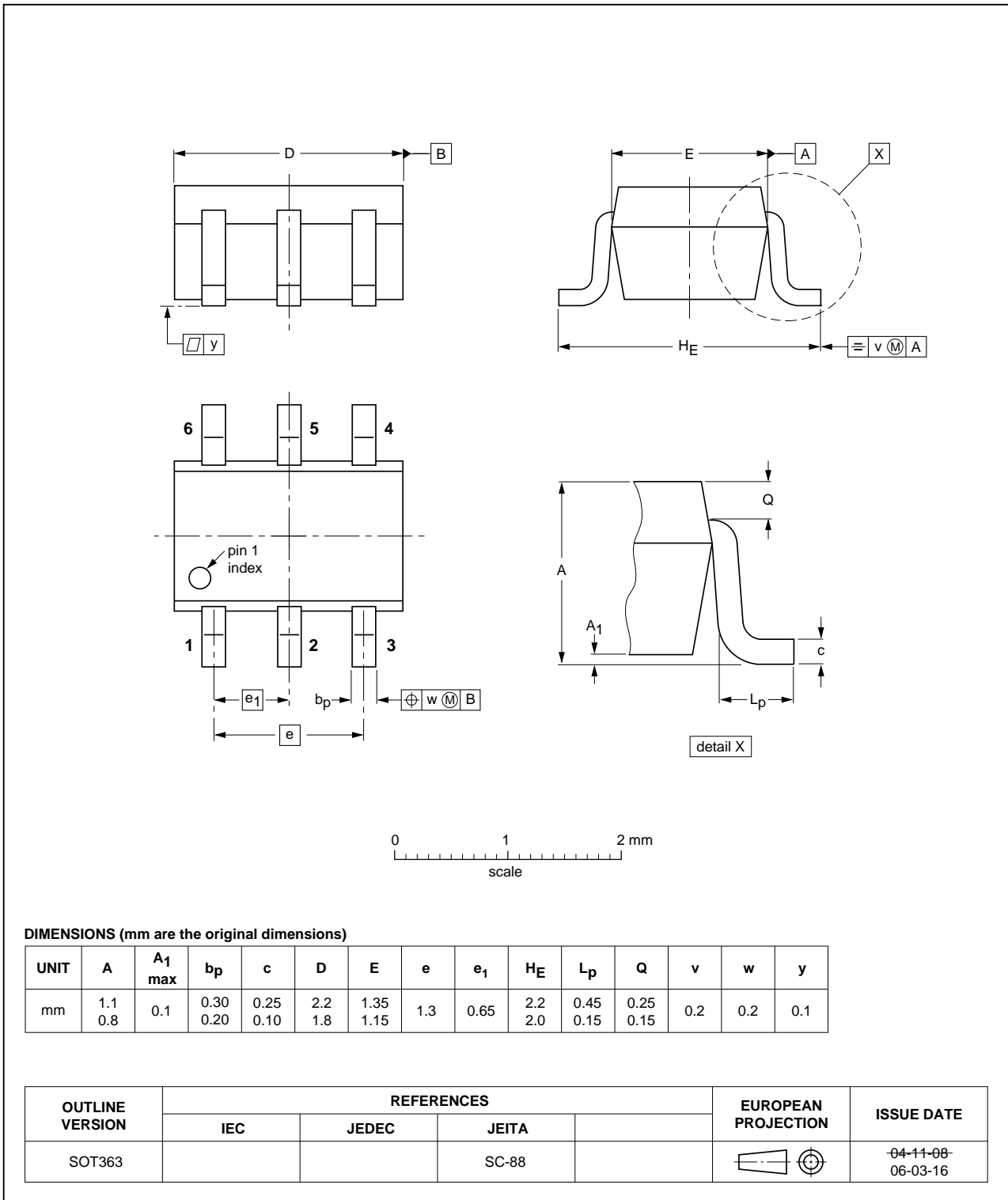

Fig 14. Package outline; SOT363 (SC-88).

10. Revision history

Table 9. Revision history

Document ID	Release date	Data sheet status	Change notice	Supersedes
BGA2717 v.3	20110908	Product data sheet	-	BGA2717 v.2
Modifications:		<ul style="list-style-type: none">• The format of this data sheet has been redesigned to comply with the new identity guidelines of NXP Semiconductors.• Legal texts have been adapted to the new company name where appropriate.• Package outline drawings have been updated to the latest version.		
BGA2717 v.2 (9397 750 13293)	20040924	Product data sheet	-	BGA2717_N v.1
BGA2717_N v.1 (9397 750 12828)	20040202	Preliminary data sheet	-	-

11. Legal information

11.1 Data sheet status

Document status ^{[1][2]}	Product status ^[3]	Definition
Objective [short] data sheet	Development	This document contains data from the objective specification for product development.
Preliminary [short] data sheet	Qualification	This document contains data from the preliminary specification.
Product [short] data sheet	Production	This document contains the product specification.

[1] Please consult the most recently issued document before initiating or completing a design.

[2] The term 'short data sheet' is explained in section "Definitions".

[3] The product status of device(s) described in this document may have changed since this document was published and may differ in case of multiple devices. The latest product status information is available on the Internet at URL <http://www.nxp.com>.

11.2 Definitions

Draft — The document is a draft version only. The content is still under internal review and subject to formal approval, which may result in modifications or additions. NXP Semiconductors does not give any representations or warranties as to the accuracy or completeness of information included herein and shall have no liability for the consequences of use of such information.

Short data sheet — A short data sheet is an extract from a full data sheet with the same product type number(s) and title. A short data sheet is intended for quick reference only and should not be relied upon to contain detailed and full information. For detailed and full information see the relevant full data sheet, which is available on request via the local NXP Semiconductors sales office. In case of any inconsistency or conflict with the short data sheet, the full data sheet shall prevail.

Product specification — The information and data provided in a Product data sheet shall define the specification of the product as agreed between NXP Semiconductors and its customer, unless NXP Semiconductors and customer have explicitly agreed otherwise in writing. In no event however, shall an agreement be valid in which the NXP Semiconductors product is deemed to offer functions and qualities beyond those described in the Product data sheet.

11.3 Disclaimers

Limited warranty and liability — Information in this document is believed to be accurate and reliable. However, NXP Semiconductors does not give any representations or warranties, expressed or implied, as to the accuracy or completeness of such information and shall have no liability for the consequences of use of such information.

In no event shall NXP Semiconductors be liable for any indirect, incidental, punitive, special or consequential damages (including - without limitation - lost profits, lost savings, business interruption, costs related to the removal or replacement of any products or rework charges) whether or not such damages are based on tort (including negligence), warranty, breach of contract or any other legal theory.

Notwithstanding any damages that customer might incur for any reason whatsoever, NXP Semiconductors' aggregate and cumulative liability towards customer for the products described herein shall be limited in accordance with the *Terms and conditions of commercial sale* of NXP Semiconductors.

Right to make changes — NXP Semiconductors reserves the right to make changes to information published in this document, including without limitation specifications and product descriptions, at any time and without notice. This document supersedes and replaces all information supplied prior to the publication hereof.

Suitability for use — NXP Semiconductors products are not designed, authorized or warranted to be suitable for use in life support, life-critical or safety-critical systems or equipment, nor in applications where failure or

malfunction of an NXP Semiconductors product can reasonably be expected to result in personal injury, death or severe property or environmental damage. NXP Semiconductors accepts no liability for inclusion and/or use of NXP Semiconductors products in such equipment or applications and therefore such inclusion and/or use is at the customer's own risk.

Applications — Applications that are described herein for any of these products are for illustrative purposes only. NXP Semiconductors makes no representation or warranty that such applications will be suitable for the specified use without further testing or modification.

Customers are responsible for the design and operation of their applications and products using NXP Semiconductors products, and NXP Semiconductors accepts no liability for any assistance with applications or customer product design. It is customer's sole responsibility to determine whether the NXP Semiconductors product is suitable and fit for the customer's applications and products planned, as well as for the planned application and use of customer's third party customer(s). Customers should provide appropriate design and operating safeguards to minimize the risks associated with their applications and products.

NXP Semiconductors does not accept any liability related to any default, damage, costs or problem which is based on any weakness or default in the customer's applications or products, or the application or use by customer's third party customer(s). Customer is responsible for doing all necessary testing for the customer's applications and products using NXP Semiconductors products in order to avoid a default of the applications and the products or of the application or use by customer's third party customer(s). NXP does not accept any liability in this respect.

Limiting values — Stress above one or more limiting values (as defined in the Absolute Maximum Ratings System of IEC 60134) will cause permanent damage to the device. Limiting values are stress ratings only and (proper) operation of the device at these or any other conditions above those given in the Recommended operating conditions section (if present) or the Characteristics sections of this document is not warranted. Constant or repeated exposure to limiting values will permanently and irreversibly affect the quality and reliability of the device.

Terms and conditions of commercial sale — NXP Semiconductors products are sold subject to the general terms and conditions of commercial sale, as published at <http://www.nxp.com/profile/terms>, unless otherwise agreed in a valid written individual agreement. In case an individual agreement is concluded only the terms and conditions of the respective agreement shall apply. NXP Semiconductors hereby expressly objects to applying the customer's general terms and conditions with regard to the purchase of NXP Semiconductors products by customer.

No offer to sell or license — Nothing in this document may be interpreted or construed as an offer to sell products that is open for acceptance or the grant, conveyance or implication of any license under any copyrights, patents or other industrial or intellectual property rights.

Export control — This document as well as the item(s) described herein may be subject to export control regulations. Export might require a prior authorization from national authorities.

Quick reference data — The Quick reference data is an extract of the product data given in the Limiting values and Characteristics sections of this document, and as such is not complete, exhaustive or legally binding.

Non-automotive qualified products — Unless this data sheet expressly states that this specific NXP Semiconductors product is automotive qualified, the product is not suitable for automotive use. It is neither qualified nor tested in accordance with automotive testing or application requirements. NXP Semiconductors accepts no liability for inclusion and/or use of non-automotive qualified products in automotive equipment or applications.

In the event that customer uses the product for design-in and use in automotive applications to automotive specifications and standards, customer (a) shall use the product without NXP Semiconductors' warranty of the

product for such automotive applications, use and specifications, and (b) whenever customer uses the product for automotive applications beyond NXP Semiconductors' specifications such use shall be solely at customer's own risk, and (c) customer fully indemnifies NXP Semiconductors for any liability, damages or failed product claims resulting from customer design and use of the product for automotive applications beyond NXP Semiconductors' standard warranty and NXP Semiconductors' product specifications.

11.4 Trademarks

Notice: All referenced brands, product names, service names and trademarks are the property of their respective owners.

12. Contact information

For more information, please visit: <http://www.nxp.com>

For sales office addresses, please send an email to: salesaddresses@nxp.com

13. Contents

1	Product profile	1
1.1	General description	1
1.2	Features and benefits	1
1.3	Applications	1
1.4	Quick reference data	1
2	Pinning information	2
3	Ordering information	2
4	Marking	2
5	Limiting values	2
6	Thermal characteristics	3
7	Characteristics	3
8	Application information	4
8.1	Grounding and output impedance	5
8.2	Application examples	6
9	Package outline	11
10	Revision history	12
11	Legal information	13
11.1	Data sheet status	13
11.2	Definitions	13
11.3	Disclaimers	13
11.4	Trademarks	14
12	Contact information	14
13	Contents	15

Please be aware that important notices concerning this document and the product(s) described herein, have been included in section 'Legal information'.

© NXP B.V. 2011.

All rights reserved.

For more information, please visit: <http://www.nxp.com>

For sales office addresses, please send an email to: salesaddresses@nxp.com

Date of release: 8 September 2011

Document identifier: BGA2717