

SPECIFICATION

Part No. : **CAB.S01**

Product Name : Taoglas Cable Assembly
IPEX MH4(HSC comp) to SMA(F)Bulkhead Straight Connector
with 100mm \varnothing 0.81 cable

Photo :



1. Cable Insertion Loss

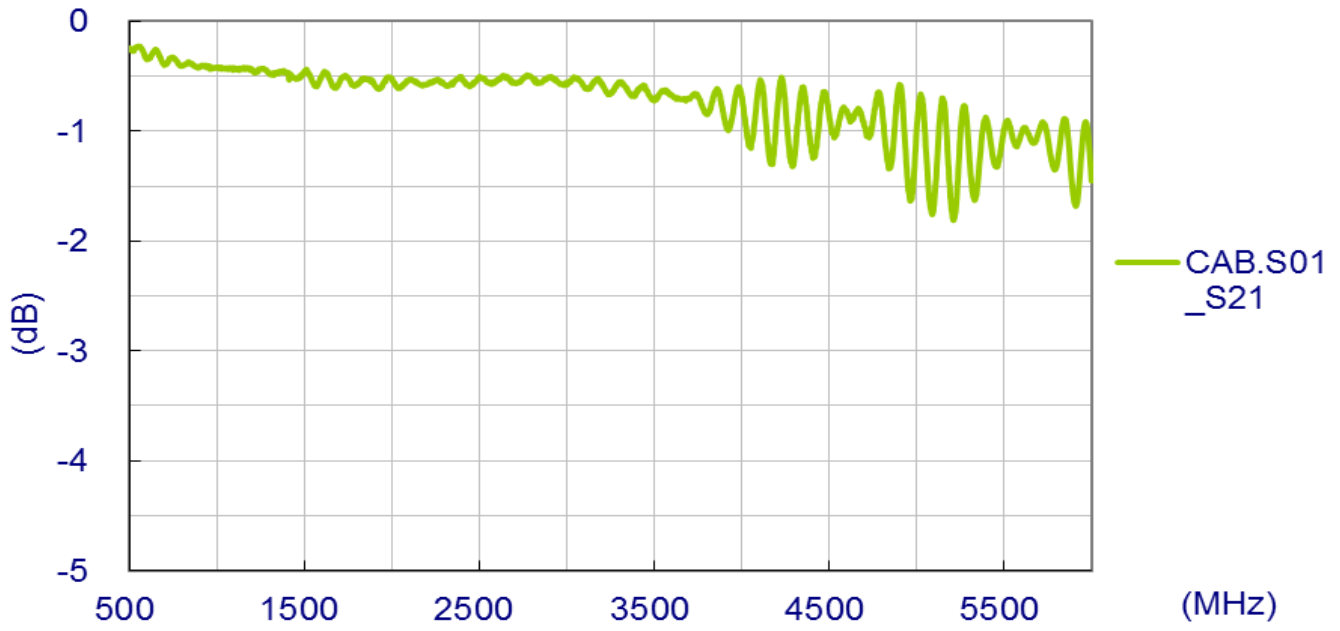

2. 0.81 Cable Specification

2.1 Drawing – Cross Section

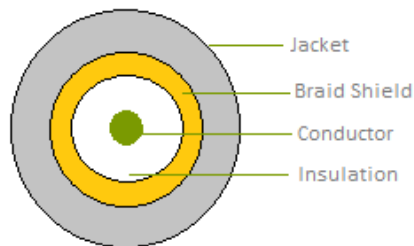

2.2 Structure and Dimensions

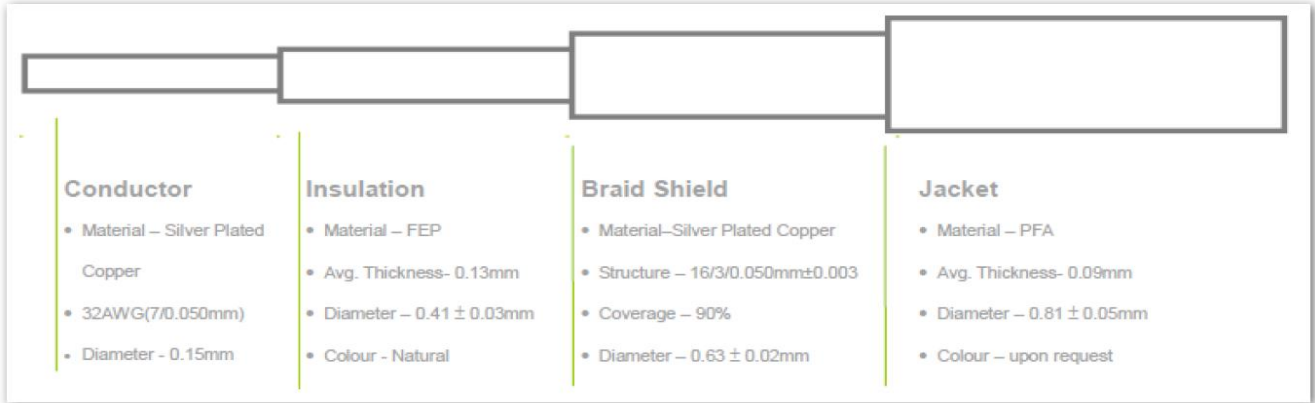

2.3 Electrical & Physical Specification

1	Insulation Resistance:	1000 MEGA OHM-KM Min.	
2	Conductor Resistance:	1400 OHM/KM/20°C Max.	
3	Dielectric Strength:	AC 1.0 KV/minute	
4	Spark test:	2.5 KV	
5	Nom. Impedance	50 ± 3 Ohms	
6	Nom. Capacitance	97 ± 3 pF/m	
7	Attenuation (dB/1M)	2.0GHz	3.60
		2.4GHz	5.10
		3.0GHz	6.20
		4.0GHz	7.50
		5.0GHz	8.50
		6.0GHz	9.40

3. Technical Drawing

3.1 CAB.S01

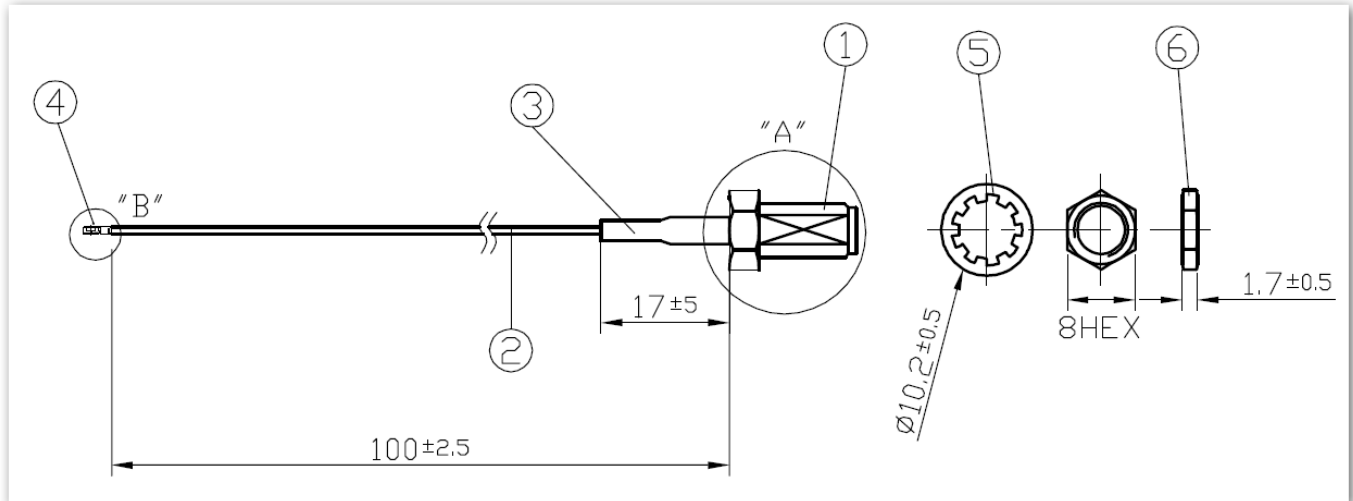

	Name	Part No.	Material	Finish	QTY
1	SMA(F) ST	SMA.F.ST.JACK.B.W	Brass	Gold	1
2	0.81 Cable	OD.081.W	FEP	Gray	1
3	Heat Shrink Tube	001312E000014A	PE	Black	1
4	IPEX MHF4	IPEX.MHF4.081	Brass	Gold	1
5	Washer	See Connector Spec	Brass	Gold	1
6	Nut	See Connector Spec	Brass	Gold	1

3.2 Connectors

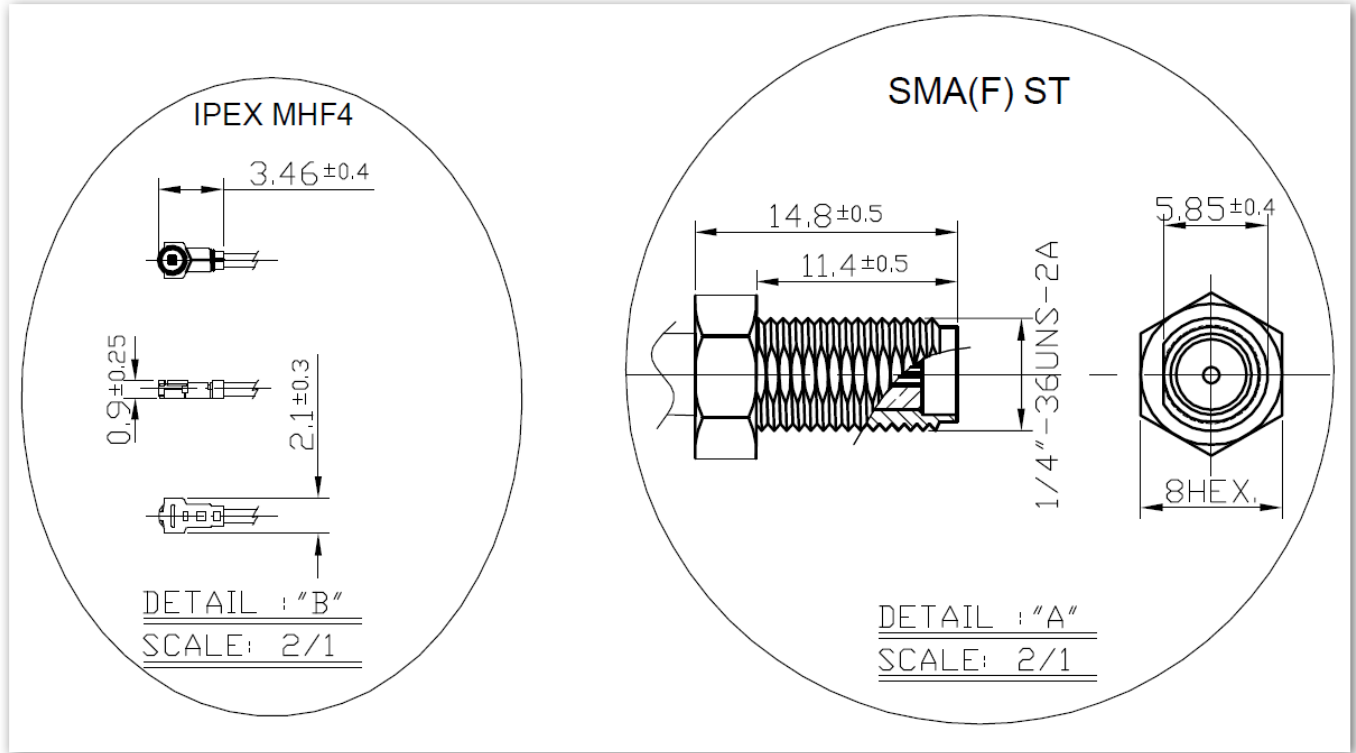

3.3 Recommended Mounting Hole – SMA(F) Bulkhead

