

To : Engineering Dept. 6
Mobile LCD Design Center
Mobile Liquid Crystal Display Group
SHARP CORPORATION

SPEC No.	E L 1 5 4 0 3 4
I S S U E : Apr. 17 2003	

S P E C I F I C A T I O N S

Product Type L Z 9 F Series 10000 Gates Gate Array

Model No. L Z 9 F D 5 3 4

※This specifications contains 21 pages including the cover and appendix.
If you have any objections, please contact us before issuing purchasing order.

CUSTOMERS ACCEPTANCE

DATA: _____

BY: _____

PRESENTED

BY: 
T. TANAKA
Dept. General Manager

REVIEWED BY: PREPARED BY:

Product Development Dept. 3
LCD LSI Division
Integrated Circuits Group
SHARP CORPORATION

- Handle this document carefully for it contains material protected by international copyright law. Any reproduction, full or in part, of this material is prohibited without the express written permission of the company.

- When using the products covered herein, please observe the conditions written herein and the precautions outlined in the following paragraphs. In no event shall the company be liable for any damages resulting from failure to strictly adhere to these conditions and precautions.
 - (1) The products covered herein are designed and manufactured for the following application areas. When using the products covered herein for the equipment listed in Paragraph (2), even for the following application areas, be sure to observe the precautions given in Paragraph (2). Never use the products for the equipment listed in Paragraph (3).
 - Office electronics
 - Instrumentation and measuring equipment
 - Machine tools
 - Audiovisual equipment
 - Home appliances
 - Communication equipment other than for trunk lines

 - (2) Those contemplating using the products covered herein for the following equipment which demands high reliability, should first contact a sales representative of the company and then accept responsibility for incorporating into the design fail-safe operation, redundancy, and other appropriate measures for ensuring reliability and safety of the equipment and the overall system.
 - Control and safety devices for airplanes, trains, automobiles, and other transportation equipment
 - Mainframe computers
 - Traffic control systems
 - Gas leak detectors and automatic cutoff devices
 - Rescue and security equipment
 - Other safety devices and safety equipment, etc.

 - (3) Do not use the products covered herein for the following equipment which demands extremely high performance in terms of functionality, reliability, or accuracy.
 - Aerospace equipment
 - Communications equipment for trunk lines
 - Control equipment for the nuclear power industry
 - Medical equipment related to life support, etc.

 - (4) Please direct all queries and comments regarding the interpretation of the above three Paragraphs to a sales representative of the company.

- Please direct all queries regarding the products covered herein to a sales representative of the company.

CONTENTS

	Page
1. Introduction	2
2. Feature	2
3. Pin Assignments	3
4. Absolute Maximum Ratings	4
5. Electrical Specifications	4
6. Netlist and Testpatterns	5
7. Package and packing specification	6 ~ 19

1. Introduction

This data sheet is to introduce the specification of LZ9FD534, which is designed by Engineering Dept. 6 Mobile LCD Design Center Mobile Liquid Crystal Display Group Sharp Corporation, timing Control IC for TFT-LCD module.

Functions: Timing Control IC for TFT-LCD module

2. Feature

Process	:	CMOS
Wafer substrate	:	P-type silicon substrate
Package	:	28QFN
Materials	:	Plastics
Operating Temperature	:	-30°C ~ +85°C
Propagation delay time	:	1.0ns/gate
(Condition : 2-input NAND, Fanout=2, wire length=2mm, supply voltage=3.0V, Operating temperature Topr=25°C)		

*REMARK

Not designed or rated as radiation hardened.
You cannot rewrite the program.

3. Pin Assignments

Pin No.	I/O	Signal Name	Pin No.	I/O	Signal Name
1	IC	A_ENAI	15	-	GND
2	IC	A_DATI	16	06M	CLK
3	ICU	D1	17	06M	PS
4	ICU	D2	18	-	V _{DD}
5	ICU	PS_SEL	19	02M	A_ENAO
6	IC	PCI	20	02M	A_DATO
7	IC	LED_ON	21	ICU	RESET
8	06M	REV	22	IC	LED_PWM
9	06M	CLS	23	02M	LED_CTL
10	02M	MOD	24	-	V _{DD}
11	02M	SPS	25	IC	VS
12	06M	LP	26	IC	HS
13	06M	SPL	27	IC	DCLK
14	ICD	TEST	28	-	GND

IC :Input buffer CMOS level

ICU :Input buffer CMOS level with PULL UP resistance (R=300k Ω)

ICD :Input buffer CMOS level with PULL DOWN resistance (R=300k Ω)

02M :Output buffer (I_{OL}=0.8mA)

06M :Output buffer (I_{OL}=2.4mA)

V_{DD} :Power supply pin

GND :Earth pin

4. Absolute Maximum Ratings

Parameter	Symbol	Rating			Unit
Supply voltage	V_{DD}	-0.3	~	+6.0	V
Input voltage	V_I	-0.3	~	$V_{DD}+0.3$	V
Output voltage	V_O	-0.3	~	$V_{DD}+0.3$	V
Operating temperature	T_{opr}	-30	~	+85	°C
Storage temperature	T_{stg}	-55	~	+150	°C

5. Electrical Specifications

5-1. Operating Conditions

Parameter	Symbol	MIN.	TYP.	MAX.	Unit
Supply voltage	V_{DD}	+2.6	+3.0	+3.6	V
Operating temperature	T_{opr}	-30		+85	°C

5-2. Electrical Characteristics

($V_{DD}=+2.6\sim+3.6V$, $T_{opr}=-30\sim+85^{\circ}C$)

Parameter	Symbol	Test conditions	MIN.	TYP.	MAX.	Unit	#
Input "Low" voltage	V_{IL}				$V_{DD}\times 0.3$	V	1
Input "High" voltage	V_{IH}		$V_{DD}\times 0.7$			V	
Input "High" current	I_{IH1}	$V_I = V_{DD}$			1.0	μA	2
Input "Low" current	I_{IL1}	$V_I = 0V$			1.0	μA	
Input "High" current	I_{IH2}	$V_I = V_{DD}$	2.0		36.0	μA	3
Input "Low" current	I_{IL2}	$V_I = 0V$			1.0	μA	
Input "High" current	I_{IH3}	$V_I = V_{DD}$			1.0	μA	4
Input "Low" current	I_{IL3}	$V_I = 0V$	2.0		36.0	μA	
Output "Low" voltage	V_{OL1}	$I_{OL} = 0.8mA$			0.4	V	5
Output "High" voltage	V_{OH1}	$I_{OH} = -0.4mA$	$V_{DD}-0.5$			V	
Output "Low" voltage	V_{OL2}	$I_{OL} = 2.4mA$			0.4	V	6
Output "High" voltage	V_{OH2}	$I_{OH} = -1.2mA$	$V_{DD}-0.5$			V	

#1: Applied to Input pins (IC, ICU, ICD).

#2: Applied to Input pins (IC).

#3: Applied to Input pin (ICD).

#4: Applied to Input pins (ICU).

#5: Applied to Output pins (O2M).

#6: Applied to Output pins (O6M).

6. Netlist and Testpatterns

Netlist

netlist name :CSUFB53.V

Testpattern

AMTTGN_1300	AMTTGN_s100
AMTTGN_1301	AMTTGN_s200
AMTTGN_o000_0116	AMTTGN_s301
AMTTGN_o100_0116	AMTTGN_s302
AMTTGN_o200_0116	AMTTGN_s303
AMTTGN_o300	AMTTGN_a101

These testpatterns are used for the final inspection of products by the appointed strobe points. The tester's frequency for the final inspection is 1MHz.

7 Package and packing specification

[Applicability]

This specification applies to IC package which are to be delivered to Mobile Liquid Crystal Display Group SHARP CORPORATION.

1.Storage Conditions.

1-1.Storage conditions required before opening the dry packing.

- Normal temperature : 5~40°C
- Normal humidity : 80% R.H. max.

1-2.Storage conditions required after opening the dry packing.

In order to prevent moisture absorption after opening, ensure the following storage conditions apply:

(1) Storage conditions for one-time soldering. (Convection reflow^{*1}, IR/Convection reflow.^{*1})

- Temperature : 5~25°C
- Humidity : 60% R.H. max.
- Period : 96 hours max. after opening.

(2) Storage conditions for two-time soldering. (Convection reflow^{*1}, IR/Convection reflow.^{*1})

a. Storage conditions following opening and prior to performing the 1st reflow.

- Temperature : 5~25°C
- Humidity : 60% R.H. max.
- Period : 96 hours max. after opening.

b. Storage conditions following completion of the 1st reflow and prior to performing the 2nd reflow.

- Temperature : 5~25°C
- Humidity : 60% R.H. max.
- Period : 96 hours max. after completion of the 1st reflow.

^{*1}:Air or nitrogen environment.

1-3.Temporary storage after opening.

To re-store the devices before soldering, do so only once and use a dry box or place desiccant (with a blue humidity indicator) with the devices and perform dry packing again using heat-sealing.

The storage period, temperature and humidity must be as follows :

(1) Storage temperature and humidity.

※1 : External atmosphere temperature and humidity of the dry packing.

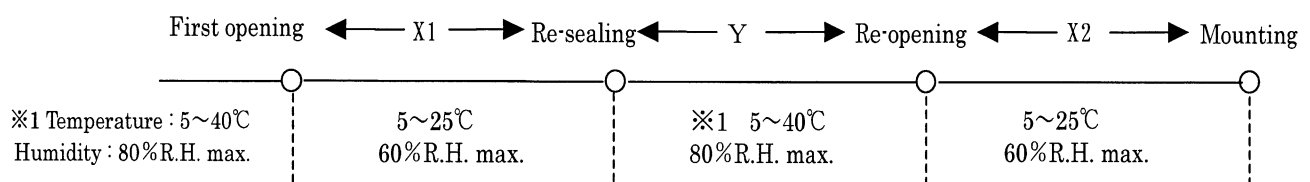

(2) Storage period.

- X1 + X2 : Refer to Section 1-2(1) and (2)a , depending on the mounting method.
- Y : Two weeks max.

2. Baking Condition.

(1) Situations requiring baking before mounting.

- Storage conditions exceed the limits specified in Section 1-2 or 1-3.
- Humidity indicator in the desiccant was already red (pink) when opened.
(Also for re-opening.)

(2) Recommended baking conditions.

- Baking temperature and period : $120 \pm 10 / -0^\circ\text{C}$ for 1~3 hours.
- The above baking conditions do not apply since the embossed carrier tape are not heat-resistant . Replace the devices on heat-resistant carrier .

(3) Storage after baking.

- After baking, store the devices in the environment specified in Section 1-2 and mount immediately.

3. Surface mount conditions.

The following soldering condition are recommended to ensure device quality.

3-1.Soldering.

(1) Convection reflow or IR/Convection. (one-time soldering or two-time soldering in air or nitrogen environment)

- Temperature and period :
Peak temperature of 250°C max.
Above 220°C for 40~60 sec.
Preheat temperature of $150 \sim 200^\circ\text{C}$ for 120 ± 30 sec.
Temperature increase rate of $1 \sim 3^\circ\text{C} / \text{sec}$.
- Measuring point : IC package surface.
- Temperature profile :

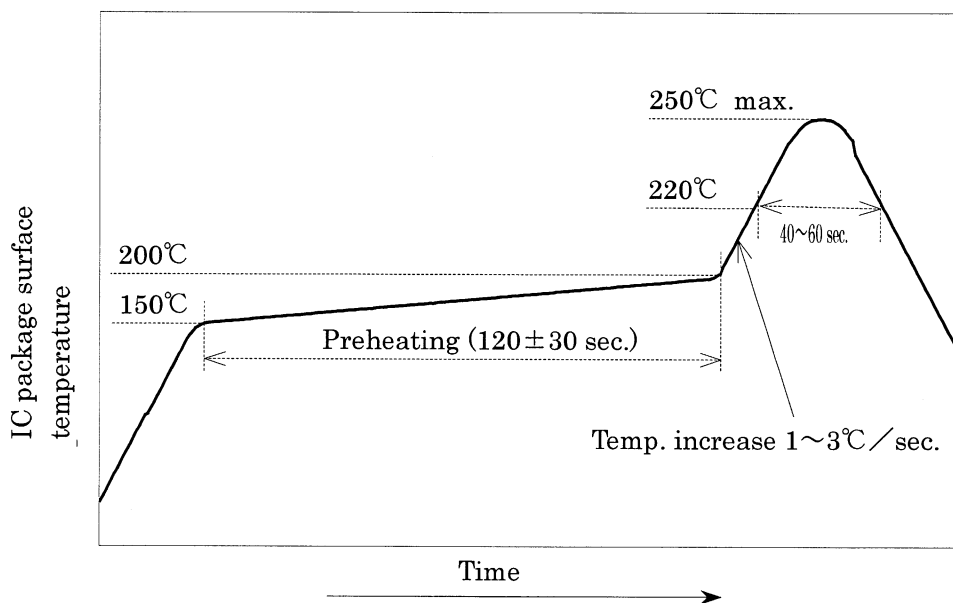

4. Condition for removal of residual flux.

- (1) Ultrasonic washing power : 25 watts / liter max.
- (2) Washing time : Total 1 minute max.
- (3) Solvent temperature : $15 \sim 40^\circ\text{C}$

5. Package outline specification.

Refer to the attached drawing.

6. Markings.

6-1. Marking details. (The information on the package should be given as follows.)

- (1) Product name : 9FD53
- (2) Company name : SHARP
- (3) Date code

(Example) Y M W

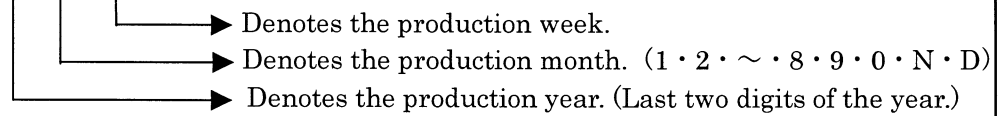

6-2. Marking layout.

The layout is shown in the attached drawing.

(However, this layout does not specify the size of the marking character and marking position.)

TOP VIEW

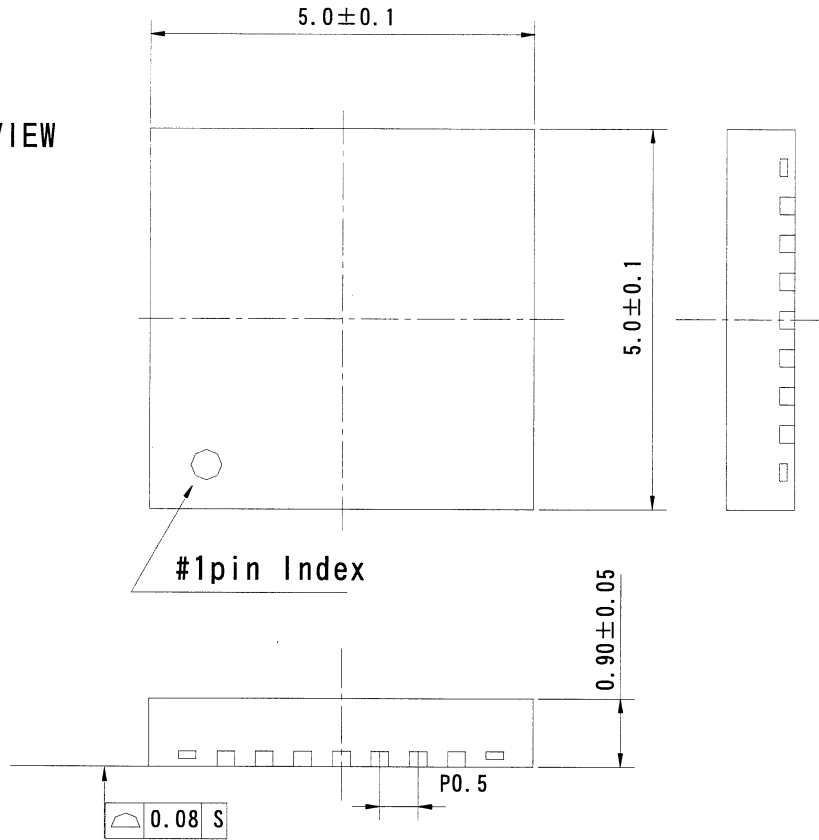

BOTTOM VIEW

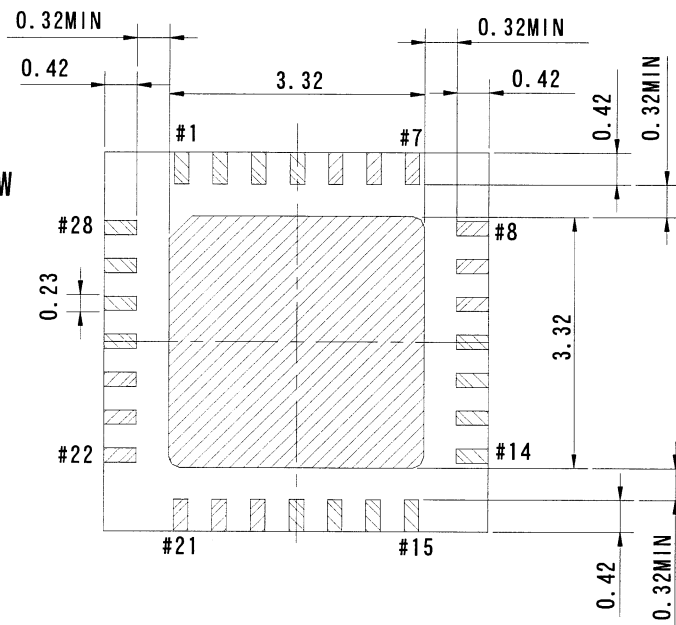

DIMENSIONAL TOLERANCE UNLESS OTHERWISE SPECIFIED ±0.08

リード表面処理 LEAD FINISH	Ni/Pd/Au メッキ Ni/Pd/Au PLATING	リード材質 LEAD MATERIAL	Cu
名称 NAME	HQFN028-P-0505		備考 プラスチックパッケージ外形寸法は、バリを含まないものとする。
DRAWING NO.	AA2182	単位 UNIT	mm
			NOTE Plastic body dimensions do not include burr of resin.

マークイメージ図
Marking image

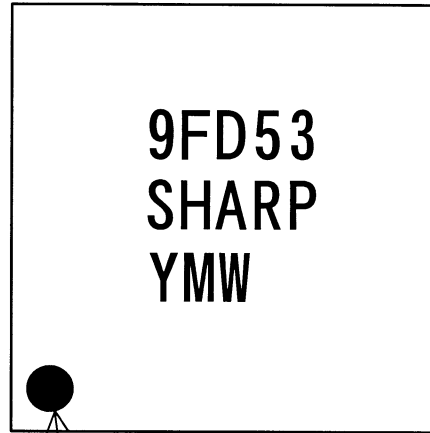

Index Mark

7. Packing specifications (Embossed carrier tape specifications)

This standard applies to the embossed carrier tape specifications for ICs supplied by SHARP CORPORATION. SHARP's embossed carrier tape specifications are generally based on those described in JIS C 0806 (Japanese Industrial Standard) and EIA481A.

7-1. Tape structure

The embossed carrier tape is made of conductive plastic. The embossed portions of the carrier tape are filled with IC packages and a top covering tape is used to enclose them.

7-2. Taping reel and embossed carrier tape size

For the taping reel and embossed carrier tape sizes, refer to the attached drawing.

7-3. IC package enclosure direction in embossed carrier tape

The IC package enclosure direction in the embossed portion relative to the direction in which the tape is pulled is indicated by an index mark on the package (indicating the No. 1 pin) shown in the attached drawing.

7-4. Missing IC packages in embossed carrier tape

The number of missing IC packages in the embossed carrier tape per reel should not exceed Either 1 or 0.1 % of the total contained on the tape per reel, whichever is larger. There should never be more than two consecutive missing IC packages.

7-5. Tape joints

There is no joint in an embossed carrier tape.

7-6. Peeling strength of the top covering tape

Peeling strength must meet the following conditions.

- (1) Peeling angle at $165^{\circ} \sim 180^{\circ}$.
- (2) Peeling speed at 300mm/min .
- (3) Peeling strength at 0.2~0.7N (20~70gf) .

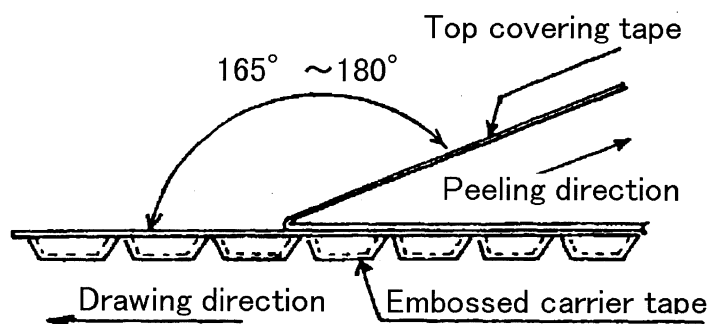

7-7. Packing

- (1) The top covering tape (leader side) at the leading edge of the embossed carrier tape, and the trailing edge of the embossed carrier tape, should both be held in place with paper adhesive tape at least 30 mm in length.
- (2) The leading and trailing edges of the embossed carrier tape should be left empty (with embossed portions not filled with IC packages) in the attached drawing.
- (3) The number of IC packages enclosed in the embossed carrier tape per reel should generally comply with the list given below.

Number of IC Packages/ Reel	Number of IC Packages/ Inner carton	Number of IC Packages/ Outer carton
2500 devices / Reel	2500 devices / Inner carton	12500 devices / Outer carton

7-8.Indications

The following should be indicated on the taping reel and the packing carton.

- Part Number (Product Name) • Storage Quantity • Packed date
- Manufacture's Name (SHARP)

Note : The IC taping direction is indicated by " EL " suffixed to the part number .

EL : Equivalent to " L " of the JIS C 0806 standard..

7-9.Protection during transportation

The IC packages should have no deformation and deterioration of their electrical Characteristics resulting from transportation.

8.Precautions for use.

- (1) Opening must be done on an anti-ESD treated workbench.
All workers must also have undergone anti-ESD treatment.
- (2) The devices should be mounted the devices within one year of the date of delivery.

EMBOSS TAPING TYPE (EL)

IC TAPING DIRECTION

THE DRAWING DIRECTION OF TAPE →

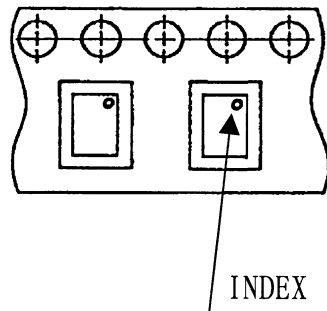

LEADER SIDE AND END SIDE OF TAPE

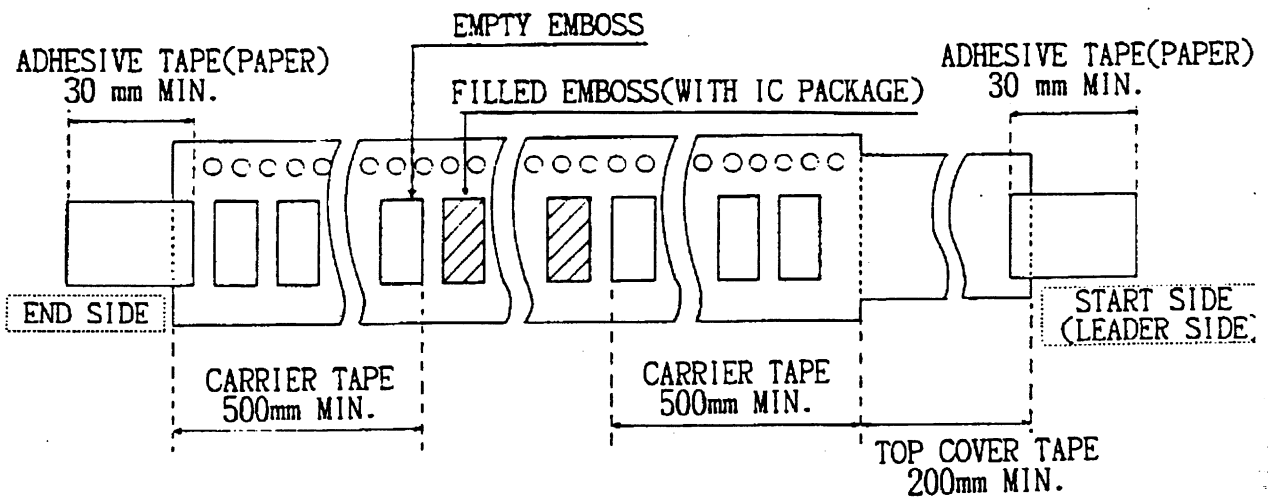

名称 NAME	Emboss taping type (EL)	備考 NOTE		
DRAWING NO.	CV522	単位 UNIT	mm	

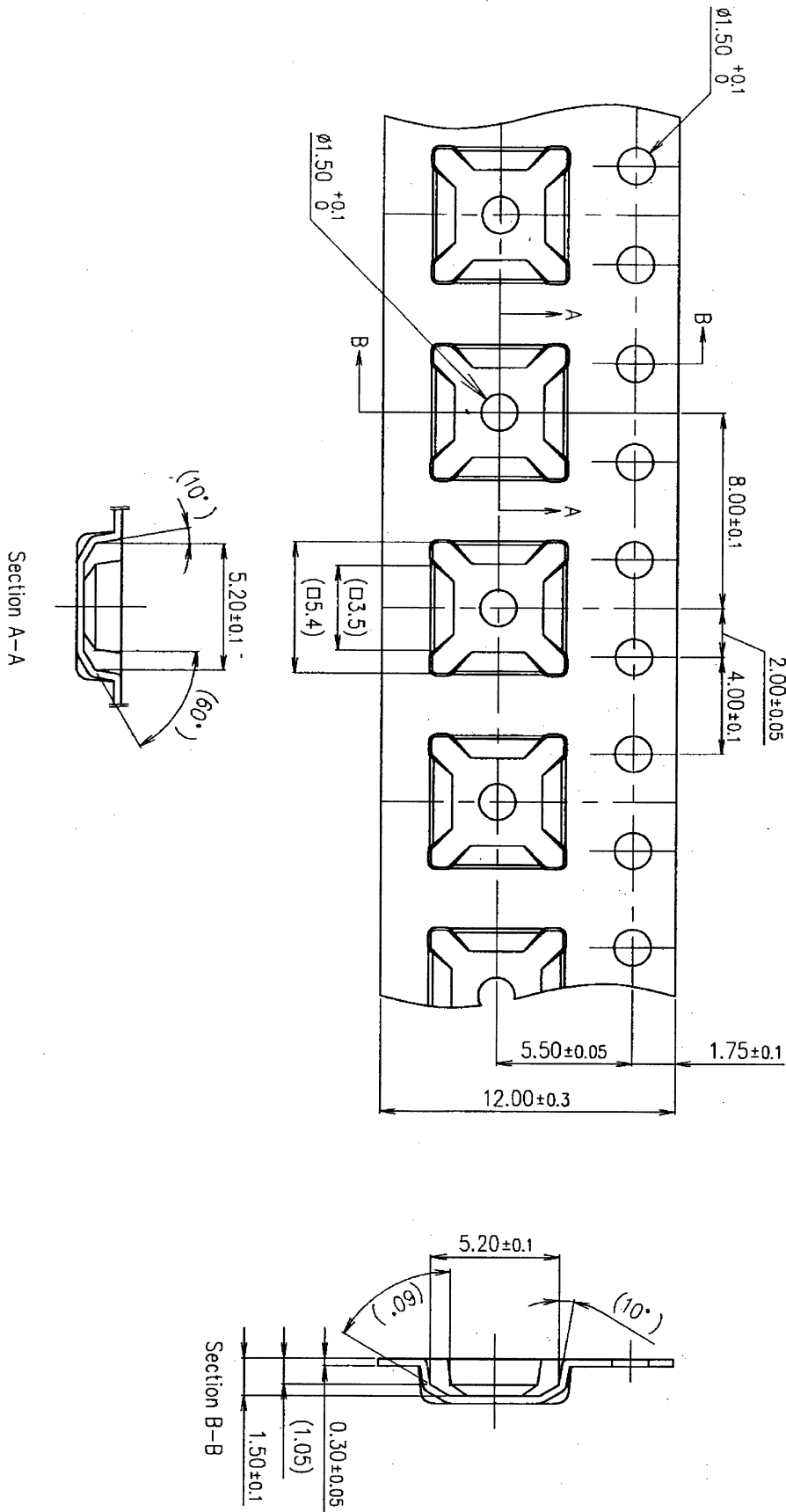

名称 NAME	EC28-0505VQNSS		備考 NOTE
DRAWING NO.	CV872	単位 UNIT	mm

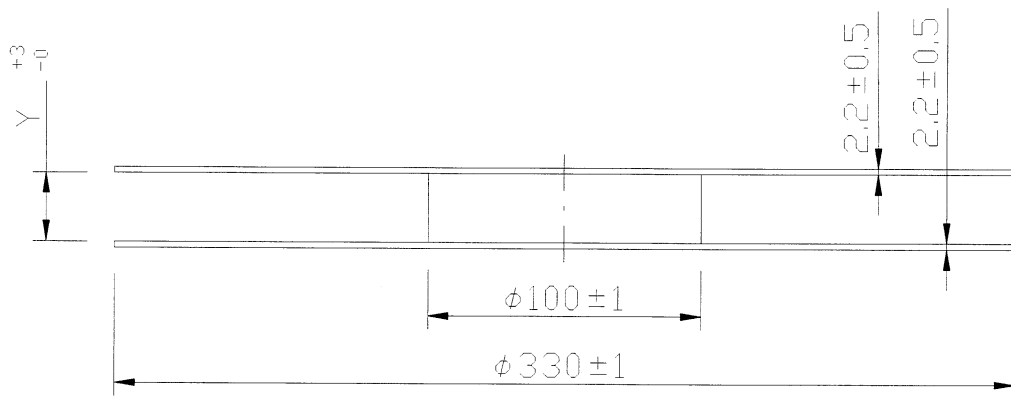
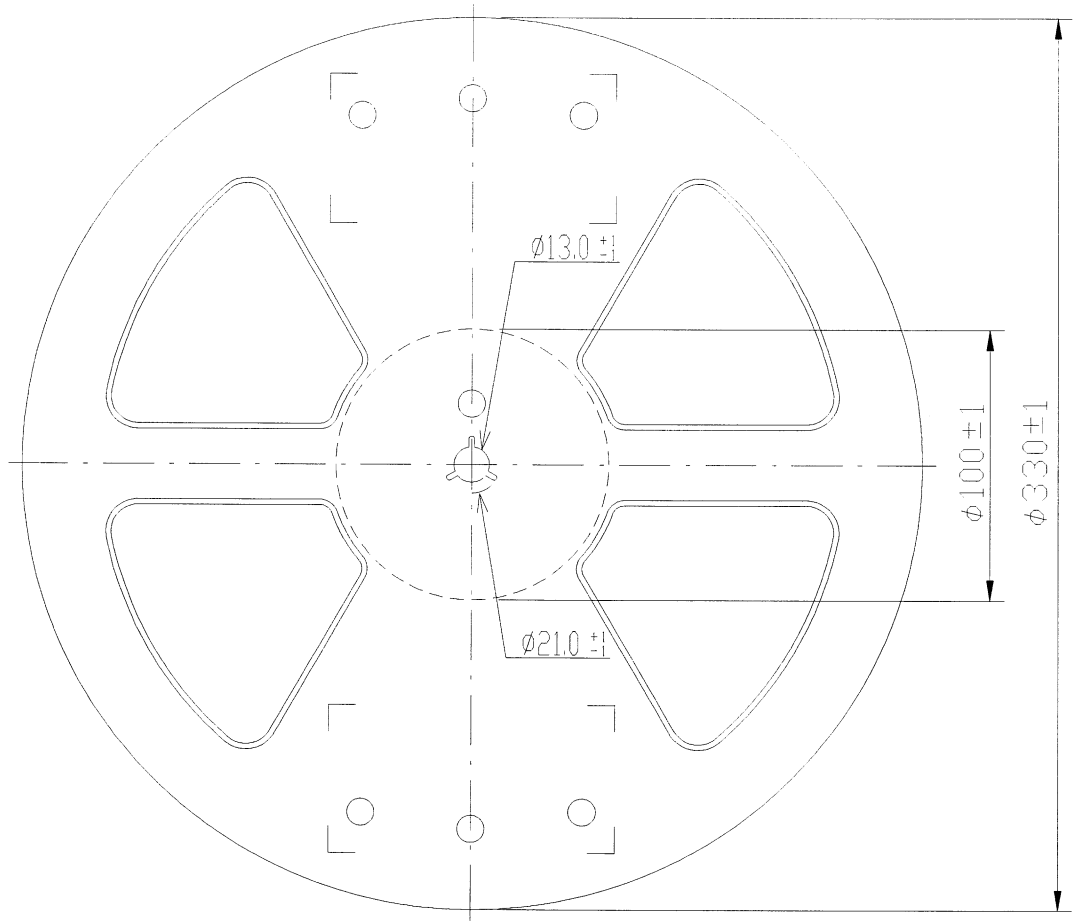

SIZE	Y	SIZE	Y
8mm	9.5	32mm	33.5
12mm	13.5	44mm	45.5
16mm	17.5	56mm	57.5
24mm	25.5		

名称 NAME	Reel for embossed carrier tape			備考 NOTE
DRAWING NO.	CV755	単位 UNIT	mm	

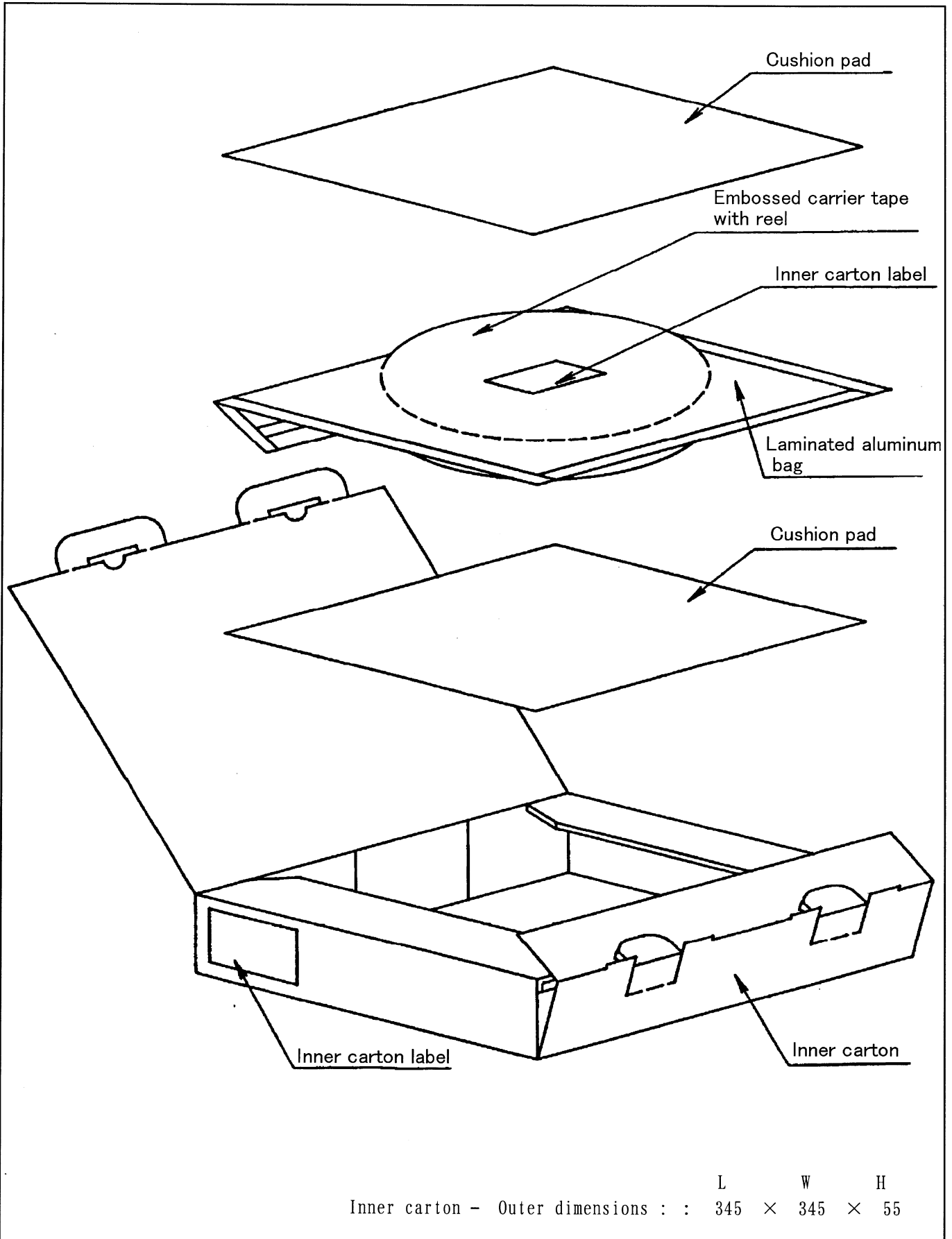

名称 NAME	Packing specifications 《1》			備考 NOTE
DRAWING NO.	CV428	単位 UNIT	mm	

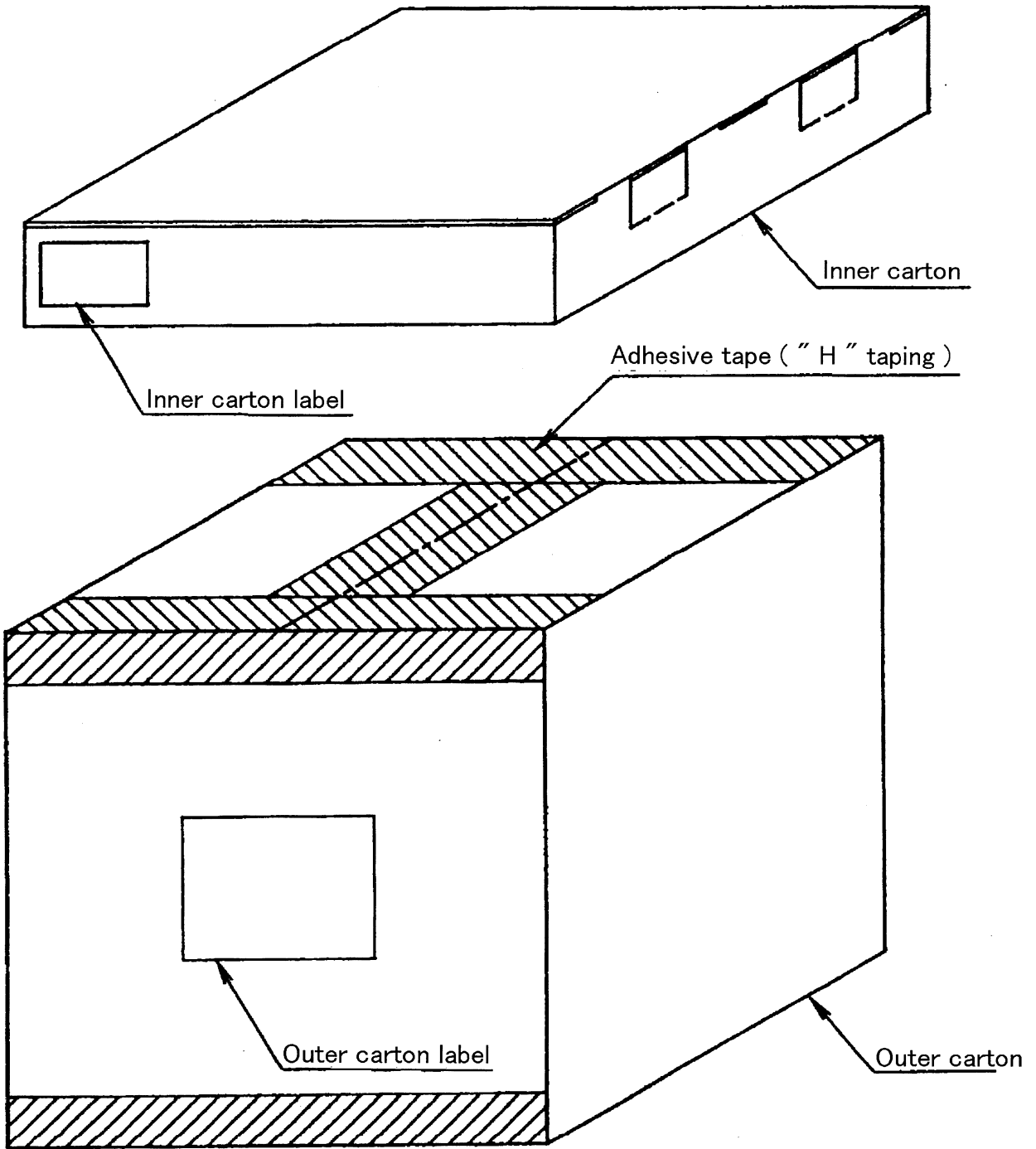

L W H

Inner carton - Outer dimensions : 345 × 345 × 55

Outer carton - Outer dimensions : 365 × 315 × 385

名称 NAME	Packing specifications 《2》	備考 出荷数量が端数の場合、本仕様と異なることがあります。 NOTE There is a possibility different from this specification when the number of shipments is fractions.	
DRAWING NO.	BJ426	単位 UNIT	mm

(*)The Lead-Free product will be printed as "Lead-Free" on the packing label. However, it doesn't print about the current product.

Inner carton label

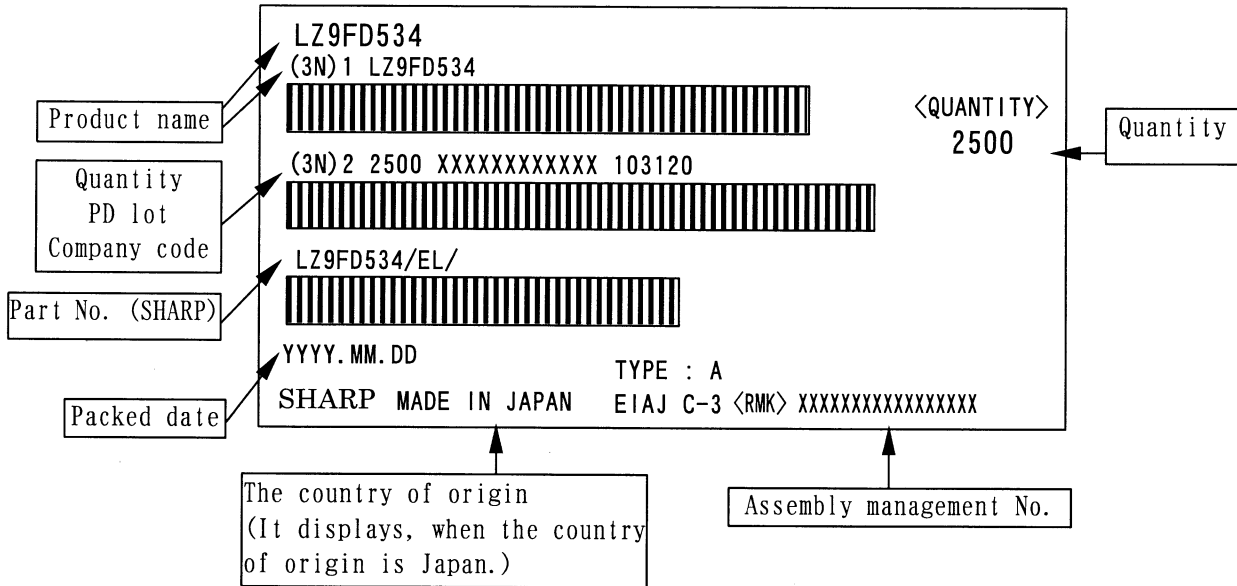

Outer carton label

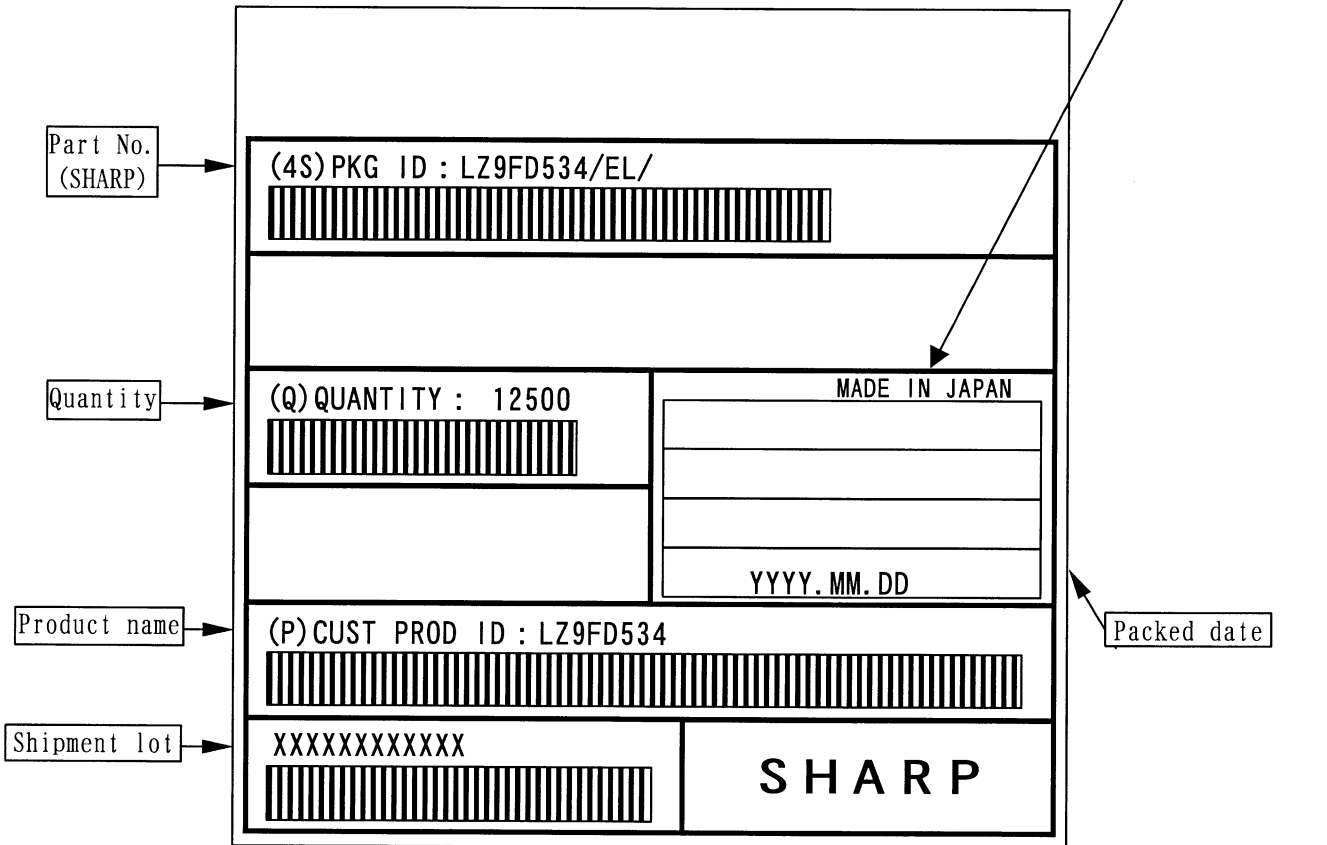

(Former) EIAJ B Standard conforming

イメージ図 (Image)

TOP VIEW

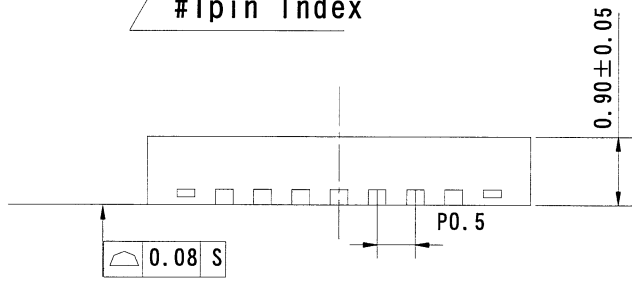
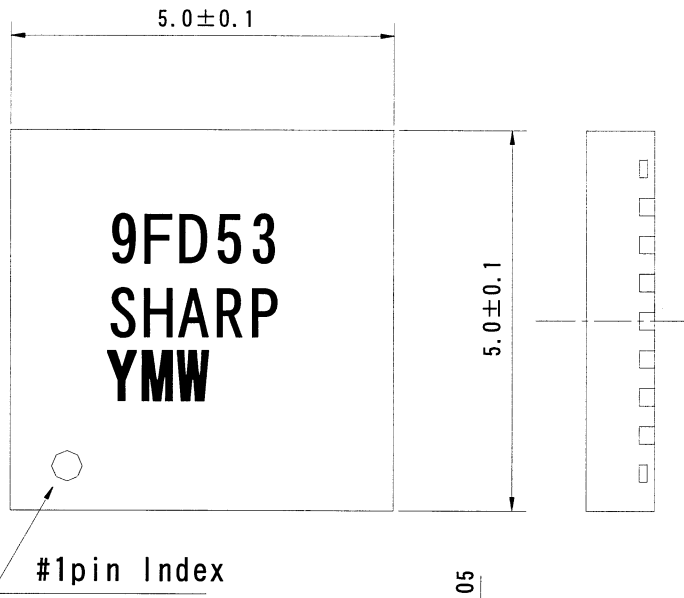

BOTTOM VIEW

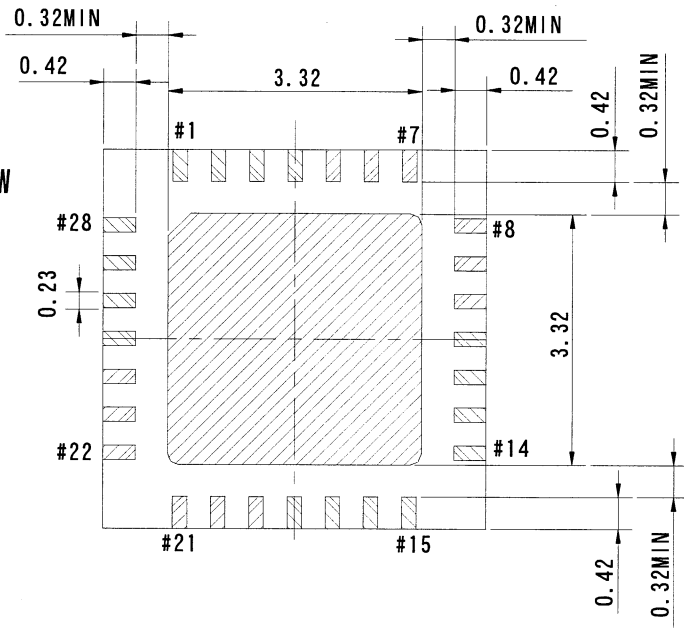

DIMENSIONAL TOLERANCE UNLESS OTHERWISE SPECIFIED ±0.08

リード表面処理 LEAD FINISH	Ni/Pd/Au メッキ Ni/Pd/Au PLATING	リード材質 LEAD MATERIAL	Cu
名称 NAME	HQFN028-P-0505		備考 プラスチックパッケージ外形寸法は、バリを含まないものとする。
DRAWING NO.	AA2182	単位 UNIT	mm
			NOTE Plastic body dimensions do not include burr of resin.