



# **GPS/GLONASS SiRFstarV Evaluation Kit EVA5100-A**

**A Description of the Evaluation Board  
for Maestro's GPS/GLONASS Receiver Module A5100-A**

## **User's Manual**

**Version 0.1**



## Revision History

Rev.	Date	Description
0.1	02-10-14	First Release
	mm-dd-yy	

	Name	Date	Signature
Written by	Happy wen	02-10-14	H W
Checked by	Sam Law, Matthieu	02-10-14	S L,M
Approval by	Frank Tang, Calvin Yau	02-10-14	F T,C Y

## Disclaimer

THIS DOCUMENT CONTAINS PROPRIETARY INFORMATION OF MAESTRO WIRELESS SOLUTIONS LIMITED. IT MAY NOT BE COPIED OR TRANSMITTED BY ANY MEANS, PASSED TO OTHERS, OR STORED IN ANY RETRIEVAL SYSTEM OR MEDIA, WITHOUT PRIOR CONSENT OF MAESTRO OR ITS AUTHORIZED AGENTS.

THE INFORMATION IN THIS DOCUMENT IS, TO THE BEST OF OUR KNOWLEDGE, ENTIRELY CORRECT. HOWEVER, MAESTRO CAN NEITHER ACCEPT LIABILITY FOR ANY INACCURACIES, OR THE CONSEQUENCES THEREOF, NOR FOR ANY LIABILITY ARISING FROM THE USE OR APPLICATION OF ANY CIRCUIT, PRODUCT, OR EXAMPLE SHOWN IN THE DOCUMENT.

THE PRODUCT (HARD- AND SOFTWARE) DESCRIBED IN THIS DOCUMENTATION IS NOT AUTHORIZED FOR USE IN LIFE SUPPORT DEVICES OR SYSTEMS WITHOUT THE EXPRESS WRITTEN APPROVAL OF MAESTRO.

THIS DOCUMENT MAY PROVIDE LINKS TO OTHER WORLD WIDE WEB SITES OR RESOURCES. BECAUSE MAESTRO HAS NO CONTROL OVER SUCH SITES AND RESOURCES, MAESTRO SHALL NOT BE RESPONSIBLE FOR THE AVAILABILITY OF SUCH EXTERNAL SITES OR RESOURCES, AND DOES NOT ENDORSE AND IS NOT RESPONSIBLE OR LIABLE FOR ANY CONTENT, ADVERTISING, PRODUCTS, OR OTHER MATERIALS ON OR AVAILABLE FROM SUCH SITES OR RESOURCES. MAESTRO SHALL NOT BE RESPONSIBLE OR LIABLE, DIRECTLY OR INDIRECTLY, FOR ANY DAMAGE OR LOSS CAUSED OR ALLEGED TO BE CAUSED BY OR IN CONNECTION WITH USE OF OR RELIANCE ON ANY SUCH CONTENT, GOODS OR SERVICES AVAILABLE ON OR THROUGH ANY SUCH SITE OR RESOURCE.

MAESTRO RESERVES THE RIGHT TO CHANGE, MODIFY, OR IMPROVE THIS DOCUMENT OR THE PRODUCT DESCRIBED HEREIN, AS SEEN FIT BY MAESTRO WITHOUT FURTHER NOTICE.

## Table of Contents

<b>1 Introduction</b> .....	<b>5</b>
1.1 Purpose.....	5
1.2 Contents.....	5
1.3 Ordering Information .....	7
1.4 Handling Precautions.....	7
<b>2 Quick Start</b> .....	<b>8</b>
<b>3 Potential Problems with Windows</b> .....	<b>10</b>
3.1 Ballpoint Mouse.....	10
<b>4 Board Overview</b> .....	<b>12</b>
<b>5 On-Board Peripherals</b> .....	<b>13</b>
5.1 ON and RESET Push-Button .....	13
5.2 Antenna Connector .....	13
5.3 LEDs .....	14
<b>6 Design-in Support</b> .....	<b>15</b>
6.1 Terminal Block .....	15
6.2 DIP Switch Settings.....	16
6.3 ICC Jumper.....	16
<b>7 NMEA Port</b> .....	<b>17</b>
<b>8 Board Schematics</b> .....	<b>18</b>
<b>9 Related Information</b> .....	<b>20</b>
9.1 Contact.....	20
9.2 Related Documents.....	20
9.3 Related Tools.....	20
<b>10 List of Figures</b> .....	<b>21</b>
<b>11 List of Tables</b> .....	<b>21</b>

# 1 Introduction

## 1.1 Purpose

The GPS/GLONASS Evaluation Kit EVA5100-A allows an easy evaluation of Maestro's SiRFstarV GPS/GLONASS receiver module A5100-A by offering quick access to the serial ports and the most important I/O lines of the module.

The EVA5100-A serves three major purposes:

- As a demonstration package of the module's capabilities  
Powering the A5100-A GPS/GLONASS receiver module via the USB connector and connecting the GPS/GLONASS antenna with sufficient view to the sky will result in an NMEA output with position information.
- As an example how to integrate the module into a system  
The schematic in chapter "8 Board Schematics" is a basic example of how to integrate the GPS/GLONASS module into an application or system.
- To support an easy temporary design in  
The signals provided on the Evaluation Kit allow direct integration into a surrounding system making it an ideal development tool.

The EVA5100-A can especially demonstrate that an active GPS/GLONASS antenna connected to the Antenna Input will result in outstanding GPS/GLONASS performance.

## 1.2 Contents

The EVA5100-A includes the following components:

- Evaluation Board (labeled EVA5100-A) with one A5100-A GPS/GLONASS receiver
- Active GPS/GLONASS antenna
- USB cable to connect to your PC
- CD with complete documentation and SiRFLive 2.04P1 Marketing software

Please check your package for completeness and connect the components properly.



Figure 1: Evaluation board EVA5100-A



Figure 2: Active GPS/GLONASS antenna with SMA connectors



Figure 3: USB cable with A/B type connectors



Figure 4: CD

### **1.3 Ordering Information**

The complete order number for the EVA5100-A is

- EVA5100-A

The board will always be shipped with latest part number. Information on sales channels can be found on Maestro's web page.

### **1.4 Handling Precautions**

The EVA5100-A contains components that are sensitive to electrostatic discharge (ESD). Please handle with appropriate care.

## 2 Quick Start

- (1) Connect the EVA5100-A with your PC using the included USB cable.
- (2) When the PC asks for drivers select the folder “Tools\Drivers” on the included CD ROM.

**Note:** Two drivers need to be installed, the [EVA5100-A FTDI driver](#) and the [USB serial driver](#).

**Note:** During the driver installation process your Windows system will probably notify you, that the driver did not pass Windows logo testing with a warning:

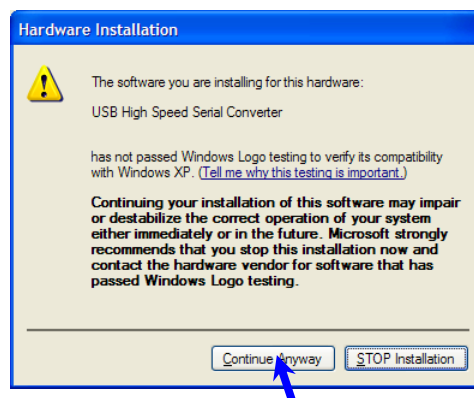
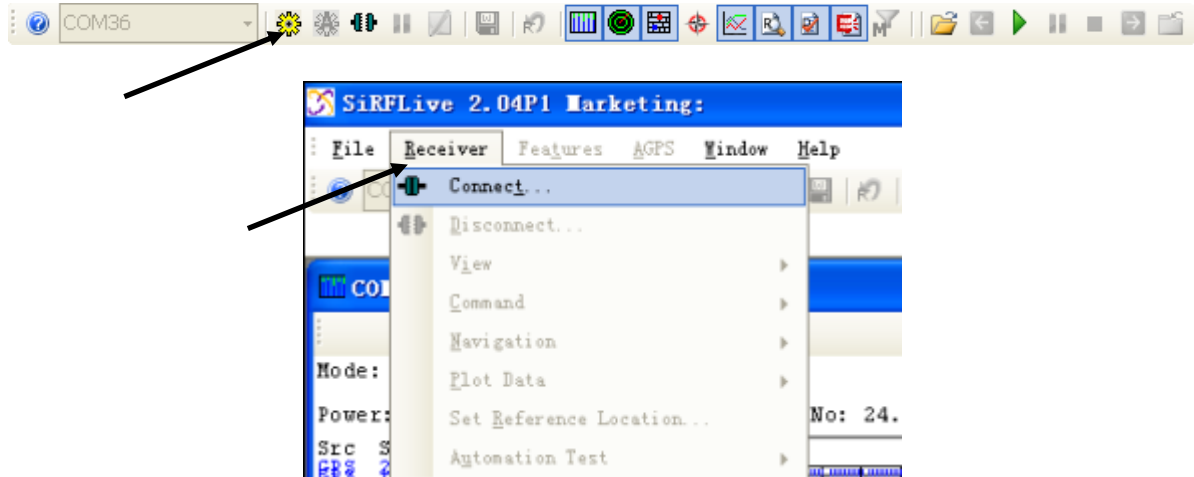

Figure 5: Windows driver installation warning

- (3) Connect the included active GPS/GLONASS antenna to the antenna connector of the EVA5100-A; make sure that the antenna has a good view to the sky!
- (4) Make sure all DIP switches are in ON position except for the GPIO7, NC pin DIP switch which must be in OFF position.
- (5) To start the SiRFLive software which visualizes the NMEA output data coming from the GPS/GLONASS receiver, copy all files from the included CD ROM “Tools/ SiRFLive” to a folder of you choice on your PC. Then double click the SiRFLive.exe file. The SiRFLive software starts installation. A detailed description of the SiRFLive software is included on the CD ROM.



- (6) Activate the correct port within SiRFLive. You can do this by selecting the “Receiver Settings button” icon (left-most icon) or by choosing “Connect” in the “Main Toolbar” menu.



In both cases the following window will appear:

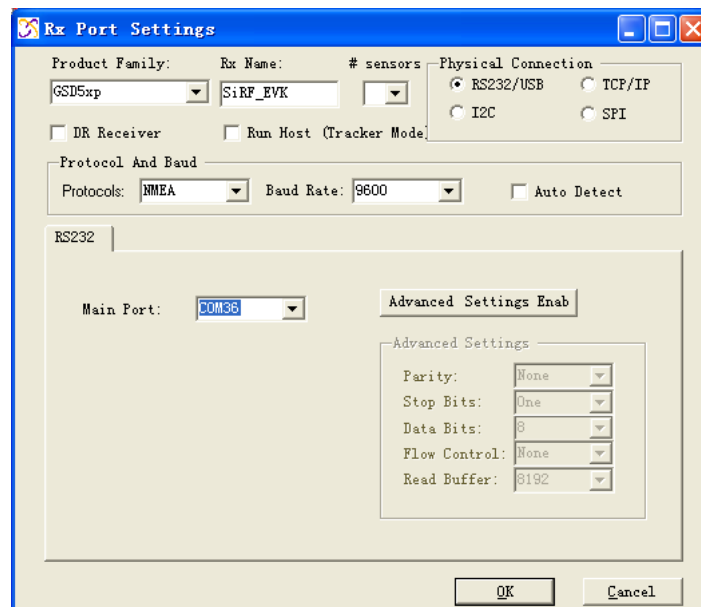

Figure 6: SiRFLive GSD5xp RS232/USB Settings window

Choose the Main port to which the GPS/GLONASS receiver is connected (verify in your system settings - device manager, which communication port is used for this USB serial connection), in our example COM36 at 9600 baud NMEA Protocol (default setting for the EVA5100-A), click on “OK”:

(7) Open the Debug View window to see NMEA sentences by using the “Debug View” window button. You will see no messages!



(8) In order to start the module, you need to push the “ON” button of the evaluation board. Then only you will see messages like this:

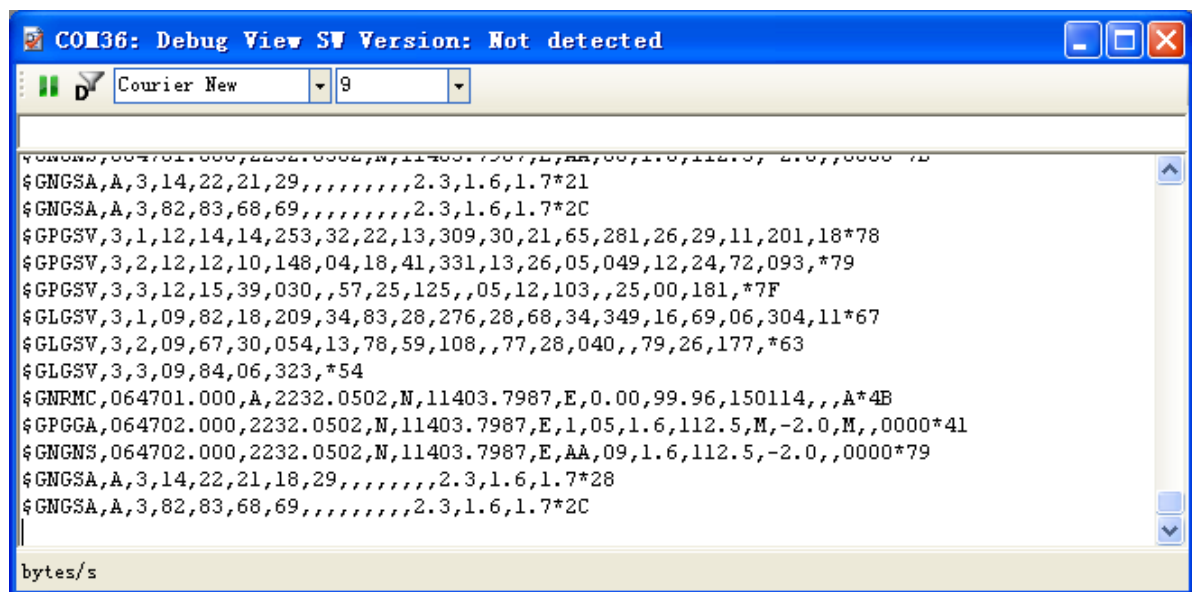

Figure 7: SiRFLive Debug View with NMEA data

Now you can start using all the other windows and features of SiRFLive. Please refer also to the SiRFLive manual and the online help within SiRFLive.

### 3 Potential Problems with Windows

#### 3.1 Ballpoint Mouse

After successful driver installation and after pushing the “ON” button of the EVA5100-A Windows might interpret the data coming over the serial interface as a serial ballpoint mouse! Your mouse pointer can start jumping around. To stop this, disable the according device using your device manager. Leave the EVA5100-A kit connected and push the nRST button once. The module will stop to transmit data. To fix the problem you will find the device under “Mice and other pointing devices”. Use a right click to open the sub-menu and disable the device.

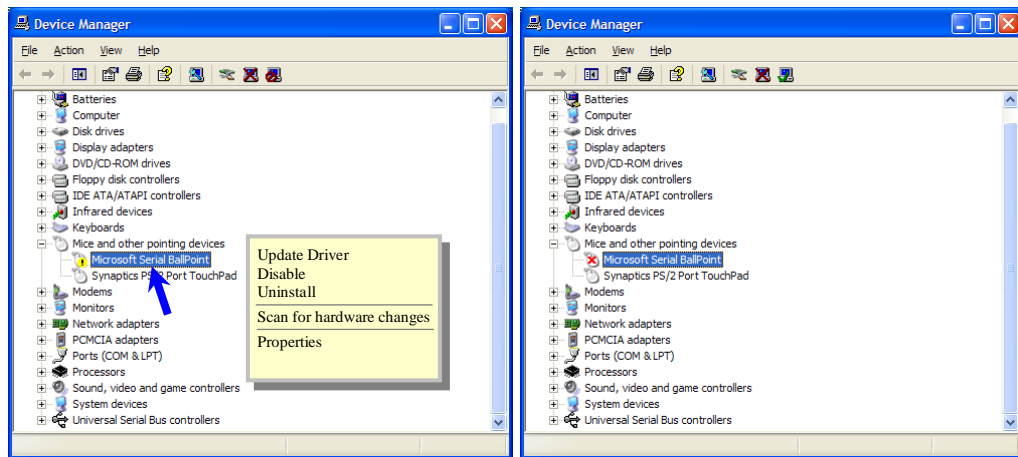

Figure 8: Disabling of Microsoft Serial BallPoint

Afterwards you will be able to continue in a normal way. Don't forget to push the "ON" button again to receive NMEA data.

## 4 Board Overview

The following picture shall give an overview on the complete evaluation board EVA5100-A. It explains the most important components and can be used as a reference for the next paragraphs.

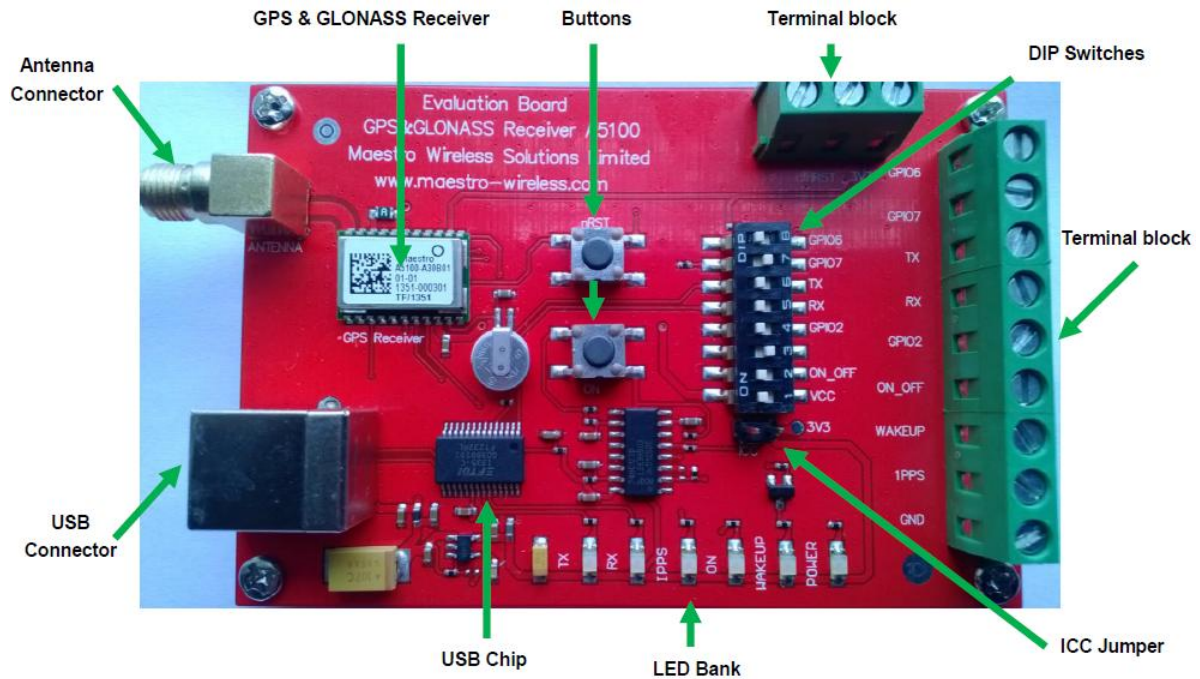

Figure 9: Board overview

## 5 On-Board Peripherals

### 5.1 ON and RESET Push-Button

The EVA5100-A has two push-buttons:

- ON (ON / OFF functionality)
- nRST (RESET functionality)

After power on pushing the “ON” button will start the A5100-A module. This is absolutely necessary to get the module going. The “ON” button must be used as well in other cases, e.g. in order to request a position when in SiRFaware™ state or to go to hibernate mode and wake up again.

The “nRST” button is used to get a full reset of the GPS/GLONASS module. All parameters are stored in non-volatile memory. After pushing this button the module starts again from the beginning.

### 5.2 Antenna Connector

The A5100-A supports one antenna input. Both active and passive GPS/GLONASS antennas can be connected to GPS/GLONASS input as below. Only active GPS/GLONASS antenna was equipped inside evaluation kit.



Figure 10: Antenna connector

### 5.3 LEDs

There are 6 LEDs on the EVA5100-A that indicate different signals from the GPS/GLONASS receiver (order of LED's on EVA5100-A from left to right):

LED	Name	Function	Description
D3	TX	Transmit	Serial data traffic (from GPS/GLONASS receiver)
D2	RX	Receive	Serial data traffic (into GPS/GLONASS receiver)
D6	1PPS	Timing	1PPS signal at rising edge (1 pulse per second, duration 500 ms typ.)
D5	ON	ON	ON after Reset, position request during PTF cycle and in SiRFaware mode (the LED visualizes the ON pulse)
D1	WAKEUP	Operational state	HIGH: Full operation LOW: Module in a low power mode
D4	POWER	Power/Vcc	Power on LED

Table 1: LEDs function and description



Figure 11: EVA5100-A LEDs

## 6 Design-in Support

The EVA5100-A Evaluation board offers the possibility to implement the A5100-A GPS/GLONASS receiver module temporarily into your design by using the terminal block with 15 connections. To operate the EVA5100-A via this terminal block, please check “Table 3: Switch settings”.

Please note:

- VCC power input is not protected against reversed polarity
- External supply has to be within the range of 3.3 to 3.6 VDC

### 6.1 Terminal Block

The terminal block offers direct access to the A5100-A GPS/GLONASS receiver pins.

Pin	Port
1	NC
2	nRST
3	3V3
4	GPIO6
5	GPIO7
6	TX
7	RX
8	GPIO 2
9	ON_OFF
10	WAKEUP (operational mode)
11	1PPS (Pulse Per Second)
12	GND

Table 2: Terminal block description



Figure 12: Terminal block

## 6.2 DIP Switch Settings

The following picture shows the DIP switches of the EVA5100-A.

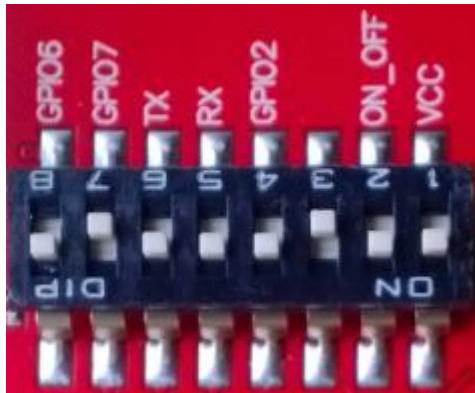

Figure 13: DIP switches (picture turned by 90° ccw)

Switch	Function	Operation via USB connector (default settings)	Operation via terminal block
S1	VCC	ON	OFF
S2	ON_OFF	ON	OFF
S3	NC	OFF	OFF
S4	GPIO2	ON	OFF
S5	RX	ON	OFF
S6	TX	ON	OFF
S7	GPIO7	OFF	OFF
S8	GPIO6	ON	OFF

Table 3: Switch settings

## 6.3 ICC Jumper



Figure 14: ICC jumper

As long as the VCC DIP switch is “ON” the ICC jumper is bridged. By putting the VCC DIP switch to the OFF position the current draw of the A5100-A GPS/GLONASS receiver can be measured directly by connecting a low resistance measurement device to the ICC jumper.

The low resistance measurement device should be connected before VCC is switched off!



## 7 NMEA Port

- Default setting: 9600 baud, 8 data bits, no parity, 1 stop bit, no flow control!
- Standard NMEA-0183 output on NMEA, baud rate selectable.
- Standard USB connectors

## 8 Board Schematics

The following shows the schematics of the EVA5100-A. For best readability the picture was enlarged to cover the complete page.

Please note that the design is done in a way that it reflects the Minimum Configuration as outlined in the GPS/GLONASS Receiver Manual A5100! These are especially:

- The A5100-A needs an external pull-up resistor to be configured for UART operation. Please consider the pull-up resistor in your design or pull the GPIO up right after reset by other means.
- The ON\_OFF input of the A5100-A needs to be connected to a push-pull output of a microprocessor. For a wake-up, including the initial one after power on, a LOW-HIGH transmission is mandatory.
- The nRST pin of the A5100-A needs to be connected to an open collector / open drain output of a microprocessor! This is necessary to work with SiRFaware™. Pulling nRST low and afterwards toggling of ON\_OFF will get the module to report a position fix when in SiRFaware™ mode.

The following picture shows the minimum configuration for using the A5100-A in UART mode with a passive antenna. In addition VANT are supported on the evaluation board!

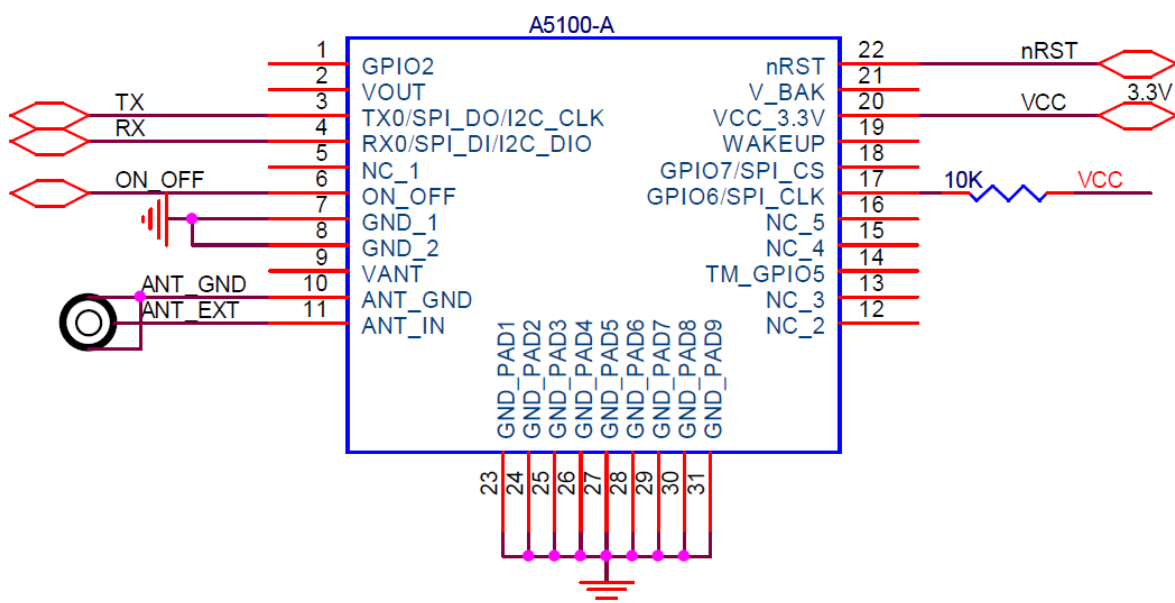

Figure 15: Minimum configuration A5100-A

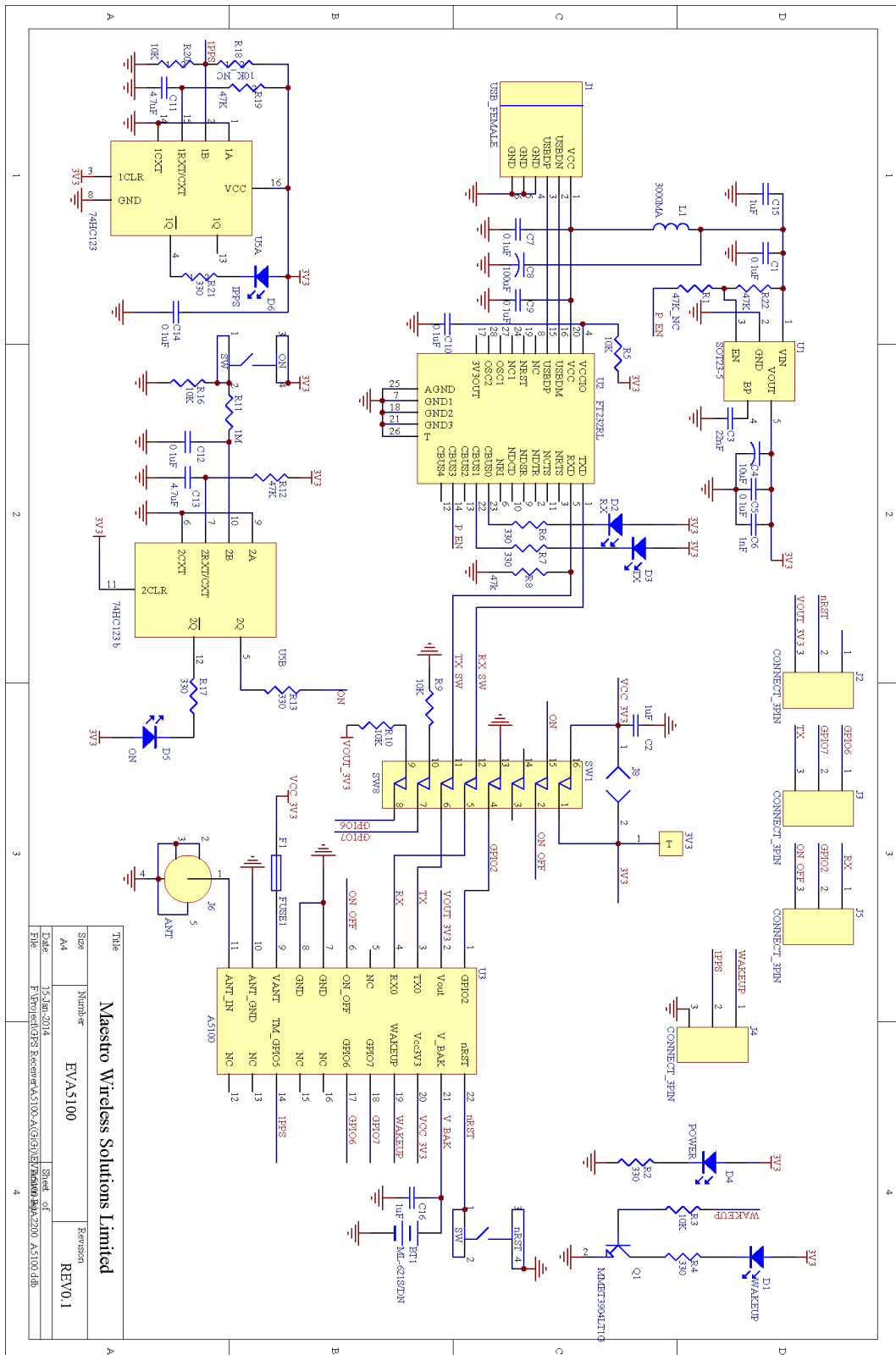

Figure 16: EVA5100-A board schematics

## **9 Related Information**

### **9.1 Contact**

This manual is created with due diligence. We hope that it will be helpful to the user to get the most out of the GPS/GLONASS module.

Inputs regarding errors or mistaken verbalizations and comments or proposals to Maestro, Hongkong, for further improvements are highly appreciated.

#### **Maestro Wireless Solutions Limited**

Add: Unit 3603-09,36/F.,118 Connaught Road West, HK

Main Line: (852) 28690688

Fax: (852)25254701

[support-gps@maestro-wireless.com](mailto:support-gps@maestro-wireless.com)

[www.maestro-wireless.com](http://www.maestro-wireless.com)

### **9.2 Related Documents**

- GPS/GLONASS Receiver A5100 (Maestro)
- SiRF\_NEMA\_Reference\_Manual (SiRF)
- SiRF\_OSP\_Reference\_Manual (SiRF)

### **9.3 Related Tools**

- SiRFLive (SiRF)

## 10 List of Figures

Figure 1: Evaluation board EVA5100-A .....	6
Figure 2: Active GPS/GLONASS antenna with SMA connectors .....	6
Figure 3: USB cable with A/B type connectors.....	6
Figure 4: CD.....	6
Figure 5: Windows driver installation warning .....	8
Figure 6: SiRFLive GSD5xp RS232/USB Settings window .....	9
Figure 7: SiRFLive Debug View with NMEA data.....	10
Figure 8: Disabling of Microsoft Serial BallPoint .....	11
Figure 9: Board overview .....	12
Figure 10: Antenna connector.....	13
Figure 11: EVA5100-A LEDs .....	14
Figure 12: Terminal block.....	15
Figure 13: DIP switches (picture turned by 90° ccw).....	16
Figure 14: ICC jumper .....	16
Figure 15: Minimum configuration A5100-A.....	18
Figure 16: EVA5100-A board schematics .....	19

## 11 List of Tables

Table 1: LEDs function and description.....	14
Table 2: Terminal block description.....	15
Table 3: Switch settings .....	16