

Bluetooth[®] low energy Module

Bluetooth[®] 4.2 low energy

EYSHCNZXZ

Data Report

The ***Bluetooth***[®] word mark and logos are owned by the ***Bluetooth*** SIG, Inc. and any use of such marks by TAIYO YUDEN CO., LTD. is under license.

Document constituent list

Control name	Control No.	Document Page
General Items	HD-AG-A150108	1/5 - 5/5
Absolute maximum ratings	HD-AM-A150108	1/1
Electrical characteristics	HD-AE-A150108	1/3 - 3/3
Circuit schematic	HD-MC-A150108	1/3 - 3/3
Outline / Appearance	HD-AD-A150108	1/3 - 3/3
Pin Layout	HD-BA-A150108	1/2 - 2/2
Handling Precaution	HQ-BA-537	1/2 - 2/2
Packaging Specification	HD-BB-A150108	1/3 - 3/3
Antenna application note		1/3 - 3/3
Design guide		1/1

Revision History

15-Mar.-2016 > Ver.1.00 Release

12-Jul.-2016 > Ver.1.1 Update

09-Aug.-2016 > Ver.1.2 Update

EYSHCNZXZ

TAIYO YUDEN

Control No. HD-AG-A150108	(1/5)	Control name General Items
------------------------------	-------	-------------------------------

1. Scope

This specification ("Specification") applies to the hybrid IC "EYSHCNZXZ", a **Bluetooth**[®] 4.2 low energy module ("Product") manufactured by TAIYO YUDEN Co., Ltd. ("TAIYO YUDEN")

2. Description

a) User Code : EYSHCNZXZ

Type : EYSHCN

*User Code may be changed for mass production or other cases.

Note: Please use the User Code (EYSHCNZXZ) to order this product

b) Chip : Nordic nRF52832 (512kB Flash, 64kB RAM)

c) Function : Radio frequency transceiver Module. Bluetooth[®]4.2 conformity.

d) Application : IoT devices, Health & Fitness Equipment, Sensor, Toys

e) Structure : Hybrid IC loaded with silicon monolithic semiconductor

Containment of hazardous substance in this Product

* This product conforms to RoHS Directive (2002/95/EC).

f) Outline : 49-pin Land Grid Array

g) Marking : Part Number, Lot Number, Japan ID, FCC ID, IC ID and manufacturer on Shielding Case

h) Country of origin : Japan

i) Packaging : Packaging method: Tape & reel + aluminum moisture barrier bag

Packaging unit: 1000

*It might be provided as tray at sample stage.

EYSHCNZXZ

TAIYO YUDEN

Control No. HD-AG-A150108	(2/5)	Control name General Items
------------------------------	-------	-------------------------------

j) Notes:

a. Limitation of Warranty

- 1) TAIYO YUDEN provides warranties only if the Product is operated under the condition set forth in this Specification. Please note that TAIYO YUDEN shall not be liable for any defect and/or malfunction arising from use of the Product under the terms and conditions other than the operating conditions hereof. In addition when this Product is used under environmental conditions such as over voltage which is not guaranteed, it may be destroyed in short mode. To ensure the security of customer's product, please add an extra fuse or/and a protection circuit for over voltage.
- 2) This Product is designed for use in products which comply with Bluetooth® 4.2 Specifications. TAIYO YUDEN disclaims and is not responsible for any liability concerning infringement by this Product under any intellectual property right owned by third party in case the customer uses this Product in any product which does not comply with Bluetooth®4.2 Specifications (the "non-complying products"). Furthermore, TAIYO YUDEN warrants only that this Product complies with this Specification and does not grant any other warranty including warranty for application of the non-complying products.
- 3) In some cases, TAIYO YUDEN may use replacements as component parts of Products. Such replacement shall apply only to component part of Products, which TAIYO YUDEN deems it possible to replace or substitute according to (i) Scope of Warranty provided in this specification (e.g. Electric Characteristics, Outline, dimension, Conditions of Use, Reliability Tests, Official Standard (Type Approvals etc.)) and (ii) Quality of Products. TAIYO YUDEN also ensures traceability of such replacement on production lot basis.

b. Instruction for Use (CAUTION)

- 1) Because Product is not designed for radiation durability, please refrain from exposing Product to radiation in the use.
- 2) Communication between this Product and other might not be established nor maintained depending upon radio environment or operating condition of this Product and other products with wireless technology.
- 3) This Product operates in the unlicensed ISM band at 2.4GHz. In case this Product is used around the other wireless devices which operate in same frequency band of this Product, there is a possibility that interference occurs between this Product and such other devices. If such interference occurs, please stop the operation of other devices or relocate this Product before using this Product or do not use this Product around the other wireless devices.
- 4) This Product mentioned in this Specification is manufactured for use in Health & Fitness Equipment, Sensor, Toys. Before using this Product in any special equipment (such as medical equipment, space equipment, air craft, disaster prevention equipment), where higher safety and reliability are duly required, the applicability and suitability of this Product must be fully evaluated by the customer at its sole risk to ensure correct and safety operation of those special equipments. Also, evaluation of the safety function of this Product even for use in general electronics equipment shall be thoroughly made and when necessary, a protective circuit shall be added in design stage, all at the customer's sole risk.

TAIYO YUDEN

Control No. HD-AG-A150108	(3/5)	Control name General Items
------------------------------	-------	-------------------------------

5) Japan Regulatory Information

This module is approved with the specific antenna on this module.

- a) Please ensure that your product can bear a label with the following information. If the product is so small that it is not practicable to place the label, please place it in the instruction manual and package.

This product installs a radio system which has been approved as a radio station in a low power data communication system based on the Radio Law.

EYSHCN : 001-A07225

6) Canada Regulatory Information

- a) This device complies with Industry Canada license-exempt RSS standards. Operation is subject to the following two conditions: (1) this device may not cause interference, and (2) this device must accept any interference, including interference that may cause undesired operation of the device.

L'utilisation de ce dispositif est autorisée seulement aux conditions suivantes: (1) il ne doit pas produire de brouillage et (2) l'utilisateur du dispositif doit être prêt à accepter tout brouillage radioélectrique reçu, même si ce brouillage est susceptible de compromettre le fonctionnement du dispositif.

- b) This product is certified as type of the portable device with Industry Canada Rules. To maintain compliance with RF Exposure requirement, please use within specification of this product.

Ce produit est certifié comme type de l'appareil portable avec Industrie Règles de Canada. Pour maintenir l'acquiescement avec exigence Exposition de RF, veuillez utiliser dans spécification de ce produit.

- IC: 4389B-EYSHCN

- c) Please notify certified ID by either one of the following method on your product.

Specifiez ID certifiée dans votre produit par une de méthode suivante.

-Contains Transmitter module IC : 4389B-EYSHCN

-Contains IC : 4389B-EYSHCN

7) FCC Regulatory Information

- a) This device complies with part 15 of the FCC Rules. Operation is subject to the following two conditions: (1) This device may not cause harmful interference, and (2) this device must accept any interference received, including interference that may cause undesired operation.

- b) Please notify certified ID by either one of the following method on your product.

-Contains Transmitter Module FCC ID: RYYEYSHCN

-Contains FCC ID: RYYEYSHCN

- c) CAUTION: changes or modifications not expressly approved by the party responsible for compliance could void the use's authority to operate the equipment.

- d) This product is certified as type of the portable device with FCC Rules. To maintain compliance with RF Exposure requirement, please use within specification of this product.

- e) The antenna used for this transmitter must not be co-located or operating in conjunction with any other antenna or transmitter.

Control No. HD-AG-A150108	(4/5)	Control name General Items
------------------------------	-------	-------------------------------

f) This module can change the output power depending on the circumstances by the application software which is developed by module installer. Any end user cannot change the output power.

8) CE Regulatory Information

- a) When your end product installs this module, it is required to proceed additional certification processes before placing on the market in EU member states to make your products fully comply with relative EU standards.
- b) TAIYO YUDEN can provide you the test reports of conducted measurement portion for the radio module. You can utilize the test reports for the certification processes of your end product as it requires radio testing.

c. Term of Support

- 1) In the case that customer requests TAIYO YUDEN to customize the hardware of this Product in order to meet such customer's specific needs, TAIYO YUDEN will make commercially reasonable effort to modify such hardware or software at customer's expense; provide however, the customer is kindly requested to agree it doesn't mean that TAIYO YUDEN has obligations to do so even in the case it is technically difficult for TAIYO YUDEN.
- 2) Any failure arising out of this Product will be examined by TAIYO YUDEN regardless of before or after mass production. Customer agrees that once such failure is turned out not to be responsible for TAIYO YUDEN after aforesaid examination, some of the technical support shall be conducted by TAIYO YUDEN at customer's expense; provided however, exact cost of this technical support can be agreed through the negotiation by the parties.
- 3) Do not alter hardware and/or software of this Product. Please note that TAIYO YUDEN shall not be liable for any problem if it is caused by customer's alteration of Hardware without Taiyo Yuden's prior approvals.
- 4) TAIYO YUDEN does not guarantee functions and performances which depend on the customer's firmware. TAIYO YUDEN does not assume liabilities for defects and failures (i) in functions, performances and quality of the Customer's product incorporating the Products and (ii) which may occur as the Product is incorporated in the Customer's product.

d. Caution for Export Control

This Product may be subject to governmental approvals, consents, licenses, authorizations, declarations, filings, and registrations for export or re-export of the Product, required by Japanese Foreign Exchange and Foreign Trade Law (including related laws and regulations) and/or any other country's applicable laws or regulations related to export control.

In case you will export or re-export this Product, you are strongly recommended to check and confirm, before exporting or re-exporting, necessary procedures for export or re-export of this Product which is required by applicable laws and regulations, and if necessary, you have to obtain necessary and appropriate approvals or licenses from governmental authority at your own risk and expense.

Control No. HD-AG-A150108	(5/5)	Control name General Items
------------------------------	-------	-------------------------------

e. Term of Warranty

TAIYO YUDEN warrants only that this Product is in conformity with this Specification for one year after purchase and shall in no event give any other warranty.

f. Items of the Specification

- 1) Any question arising from the Specification shall be solved in good faith through mutual discussion by the parties hereof.
- 2) The language of this "General items" is Japanese and this "General items" shall be interpreted by Japanese. Any copies of translation is a reference purpose only and is not binding on both parties hereto.

g. Special note

- 1) Taiyo Yuden writes firmware for and fixed SoftDevice (s132_nrf52_2.0.1_softdevice.hex) to this product. Customer writes firmware that is match the customer applications including SoftDevice at the customer's own responsibility.
- 2) The Electrical Characteristics defined in this Specification are of the module with above Firmware (s132_nrf52_2.0.1_softdevice.hex). If other firmware developed by Customer is installed, the characteristics may differ from the defined value in the Electrical Characteristics. Bluetooth qualification and radio type approval may become invalid.
- 3) EYSHCN series module is qualified as PHY only with Component category by Bluetooth SIG. The QDID of this module is 81272. The final product needs to get qualification as End product combining with PHY (module), SoftDevice and Profile before selling the product. The combination of Link and Host layer is differ with SoftDevice. Please refer to following combination and consult with your qualification body and BQE.

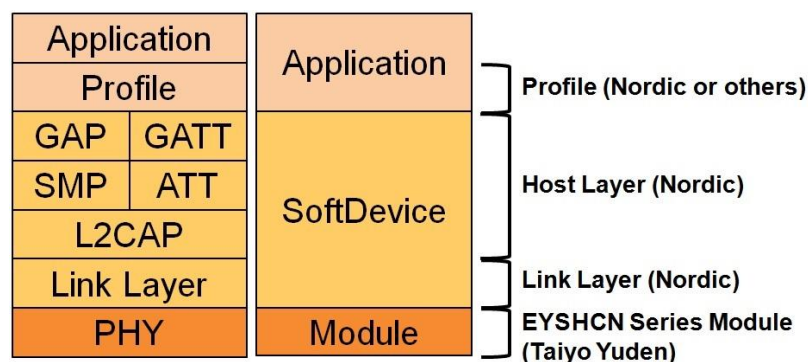

EYSHCNZXZ

TAIYO YUDEN

Control No. HD-AM-A150108	(1/1)	Control name Absolute maximum ratings
------------------------------	-------	--

Absolute maximum ratings

Symbol	Parameter	Min.	Max.	Units
VCC_NRF		-0.3	+3.9	V
GND			0	V
VIO, VCC_NRF \leq 3.6V		-0.3	VCC_NRF+ 0.3	V
VIO, VCC_NRF $>$ 3.6V		-0.3	+3.9	V
Storage temperature		-40	+85	Deg-C
MSL	Moisture Sensitivity Level	3		
ESD HBM	Human Body Model		1	kV
ESD MM	Machine Model		100	V
Endurance	Flash Memory Endurance	10000		write/erase cycles
Retention	Flash Memory Retention	10 years		At 40 deg-C
Number of times a 512 byte block can be written between erase cycles	32bit writes		181	times

EYSHCNZXZ

TAIYO YUDEN

Control No. HD-AE-A150108	(1/3)	Control name Electrical characteristics
------------------------------	-------	--

Electrical characteristics**Recommendation operating range**

Symbol	Parameter	Min.	Typ.	Max.	Units
VCC_NRF	Supply voltage, normal mode	1.7	3.0	3.6	V
tR_VCC_NRF	Supply rise time (0V to 1.7V)*1			60	ms
TA	Operation temperature*2	-40	25	85	Deg-C

*1 The on-chip power-on reset circuitry may not function properly for rise times outside the specified interval. Also after power off, it must start up from below 0.3V. The on-chip power-on reset circuitry may not function properly.

*2 ANT specification requires +/-50ppm accuracy for 32.768kHz clock. The internal 32.768kHz crystal does not meet to +/-50ppm over the whole recommended operation temperature range.

DC Specifications

The Specification applies for Topr.= 25 degrees C, VCC_NRF = 3.0V

Symbol	Parameter (condition)	Min.	Typ.	Max.	Units
VIH	Input high voltage	0.7 VCC_NRF		VCC_NRF	V
VIL	Input low voltage	GND		0.3 VCC_NRF	V
VOH	Output high voltage (high drive 5 mA)	VCC_NRF-0.4		VCC_NRF	V
VOL	Output low voltage (high drive 5 mA)	GND		GND+0.4	V
RPU	Pull-up resistance	11	13	16	Kohm
RPD	Pull-down resistance	11	13	16	Kohm
ITX,+4dBm,DCDC	TX only run current (DCDC, 3V) PRF=+4 dBm		7.5		mA
ITX,+4dBm	TX only run current PRF=+4 dBm		16.6		mA
IRX,1M,DCDC	RX only run current (DCDC, 3V) 1Mbps BLE		5.4		mA
IRX,1M	RX only run current 1Mbps BLE		11.7		mA
IOFF	Current in SYSTEM-OFF, no RAM retention		0.7		uA
ION	SYSTEM-ON base current		1.2		uA
IRAM	Additional RAM retention current per 4KB RAM block		20		nA

TAIYO YUDEN

Control No. HD-AE-A150108	(2/3)	Control name Electrical characteristics
------------------------------	-------	--

RF Specifications

Symbol	Description	Min.	Typ.	Max.	Units
Fop	Operating frequencies	2402		2480	MHz
PLLchsp	PLL channel spacing		1		MHz
Df	Frequency deviation		+/-250		kHz
PRF	Maximum output power		4	6	dBm
PRFC	RF power control range		24		dB
PRFCR	RF power accuracy			+/-4	dB
PRF1	1st Adjacent Channel Transmit Power 1 MHz		-25		dBc
PRF2	2nd Adjacent Channel Transmit Power 2 MHz		-50		dBc
PRXMAX	Maximum received signal strength at < 0.1% PER		0		dBm
PSENS IT	Receiver sensitivity (0.1% BER) Ideal transmitter <=37bytes		-96		dBm

Reference documents for electrical characteristics

nRF52832_Product Specification

http://infocenter.nordicsemi.com/topic/com.nordic.infocenter.nrf52/dita/nrf52/chips/nrf52832_ps.html

http://infocenter.nordicsemi.com/pdf/nRF52832_PS_v1.1.pdf

nRF52832_Rev1 Errata

<http://infocenter.nordicsemi.com/topic/com.nordic.infocenter.nrf52/dita/nrf52/errata.html>

http://infocenter.nordicsemi.com/pdf/nRF52832_Rev_1_Errata_v1.1.pdf

S132_SoftDevice Specification

<http://infocenter.nordicsemi.com/topic/com.nordic.infocenter.softdevices52/dita/softdevices/s130/s130.html>

http://infocenter.nordicsemi.com/pdf/S132_SDS_v2.0.pdf

For more information

<https://infocenter.nordicsemi.com/index.jsp>

Control No. HD-AE-A150108	(3/3)	Control name Electrical characteristics
------------------------------	-------	--

DFU Specifications

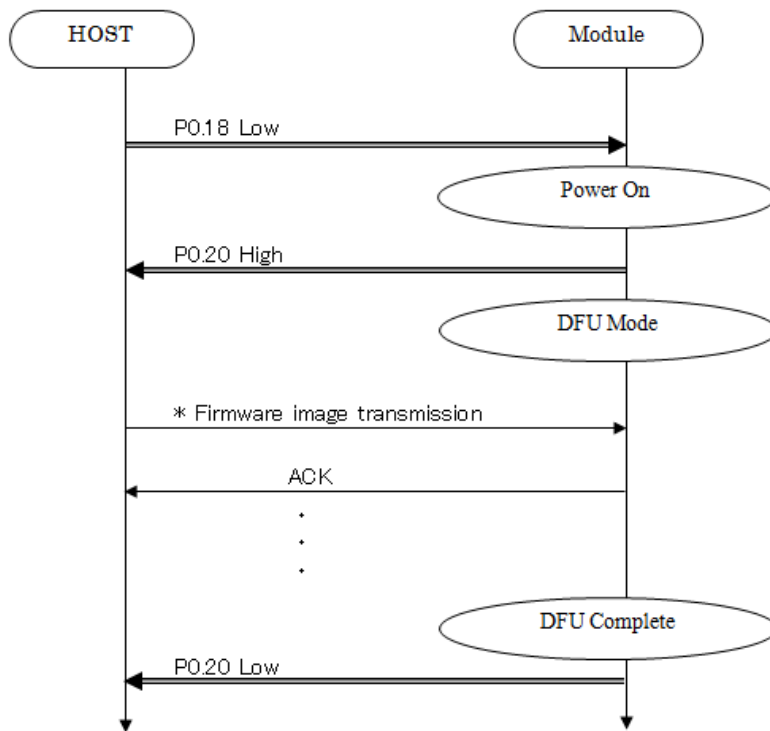

UART	
Baud rate : 38400 bps	UART PIN :
Data : 8 bit	RX : P0.08
Parity : none	TX : P0.06
Stop : 1 bit	CTS : P0.07
Hardware flow control : Enabled	RTS : P0.05

* see Nordic Infocenter and nRFgo Studio help

[Nordic Infocenter] <http://infocenter.nordicsemi.com/index.jsp>
 Software Development Kit > nRF5 SDK > nRF5 SDK v11.0.0 > Examples > DFU bootloader examples
 > BLE & HCI/UART Bootloader/DFU > Transport layers > Serial (HCI) packet format
 Software Development Kit > nRF5 SDK > nRF5 SDK v11.0.0 > Examples > DFU bootloader examples
 > BLE & HCI/UART Bootloader/DFU > Creating a DFU bootloader

[nRFgo Studio] Download from Nordic web site <http://www.nordicsemi.com>
 nRFgo Studio help > Program nRF5x devices > Serial Bootloader

Control No. HD-MC-A150108	(1/3)	Control name Circuit Schematic
------------------------------	-------	-----------------------------------

Block Diagram

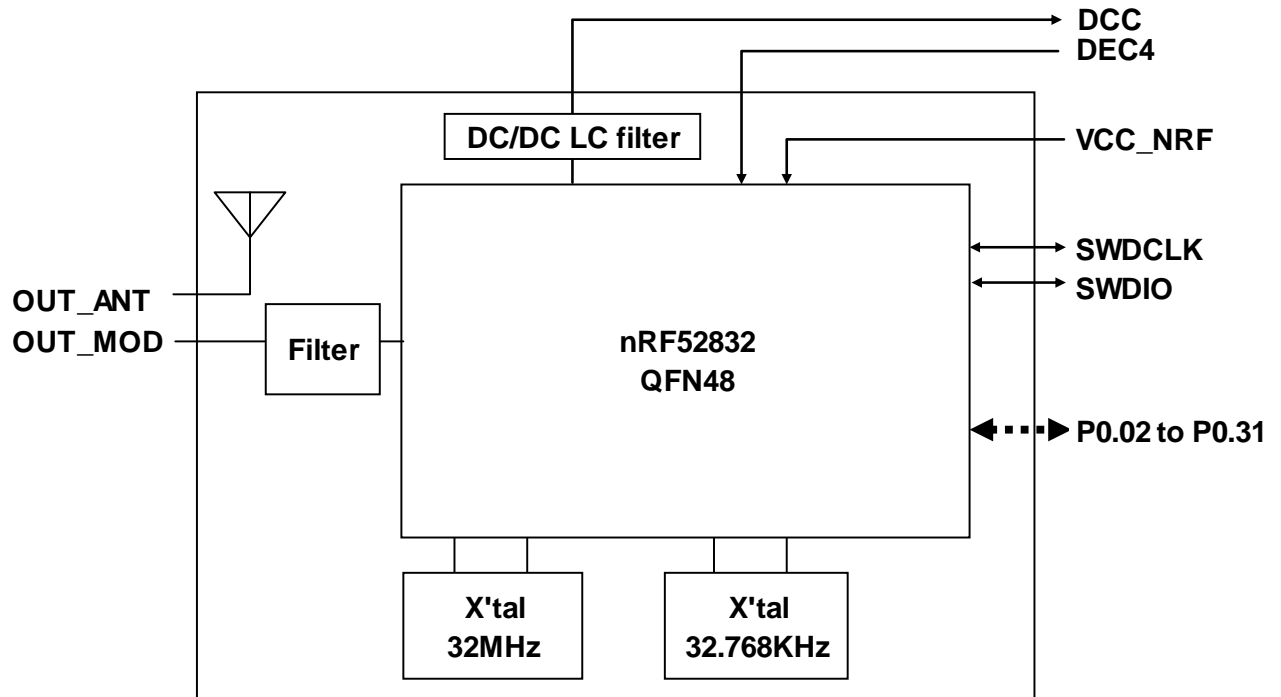

Control No. HD-MC-A150108	(2/3)	Control name Circuit Schematic
------------------------------	-------	-----------------------------------

Sample circuits

Schematic for internal LDO

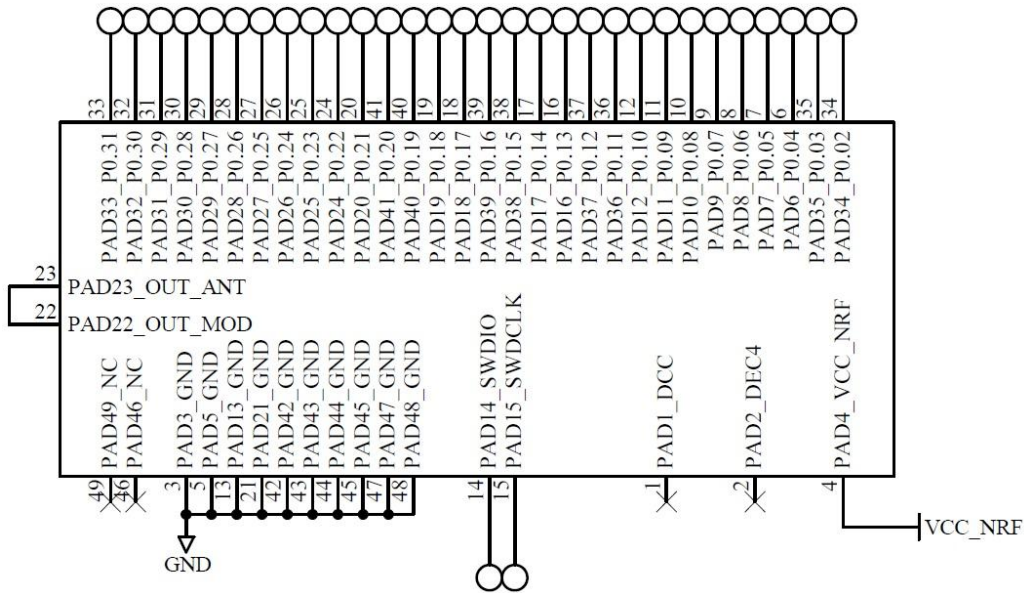

Schematic for internal DCDC (LC for DCDC is embedded in the module)

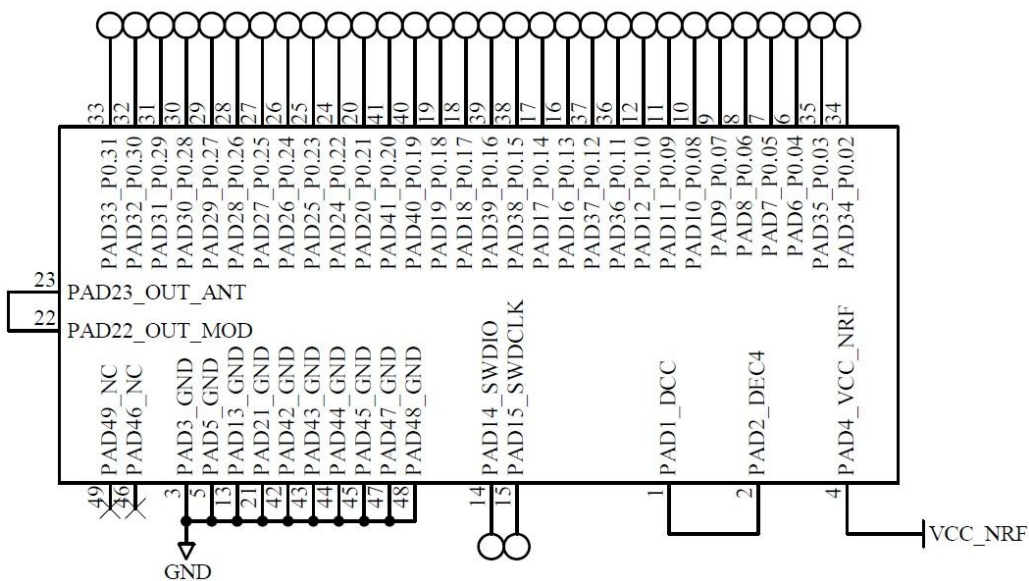

Control No. HD-MC-A150108	(3/3)	Control name Circuit Schematic
------------------------------	-------	-----------------------------------

Reference Circuits

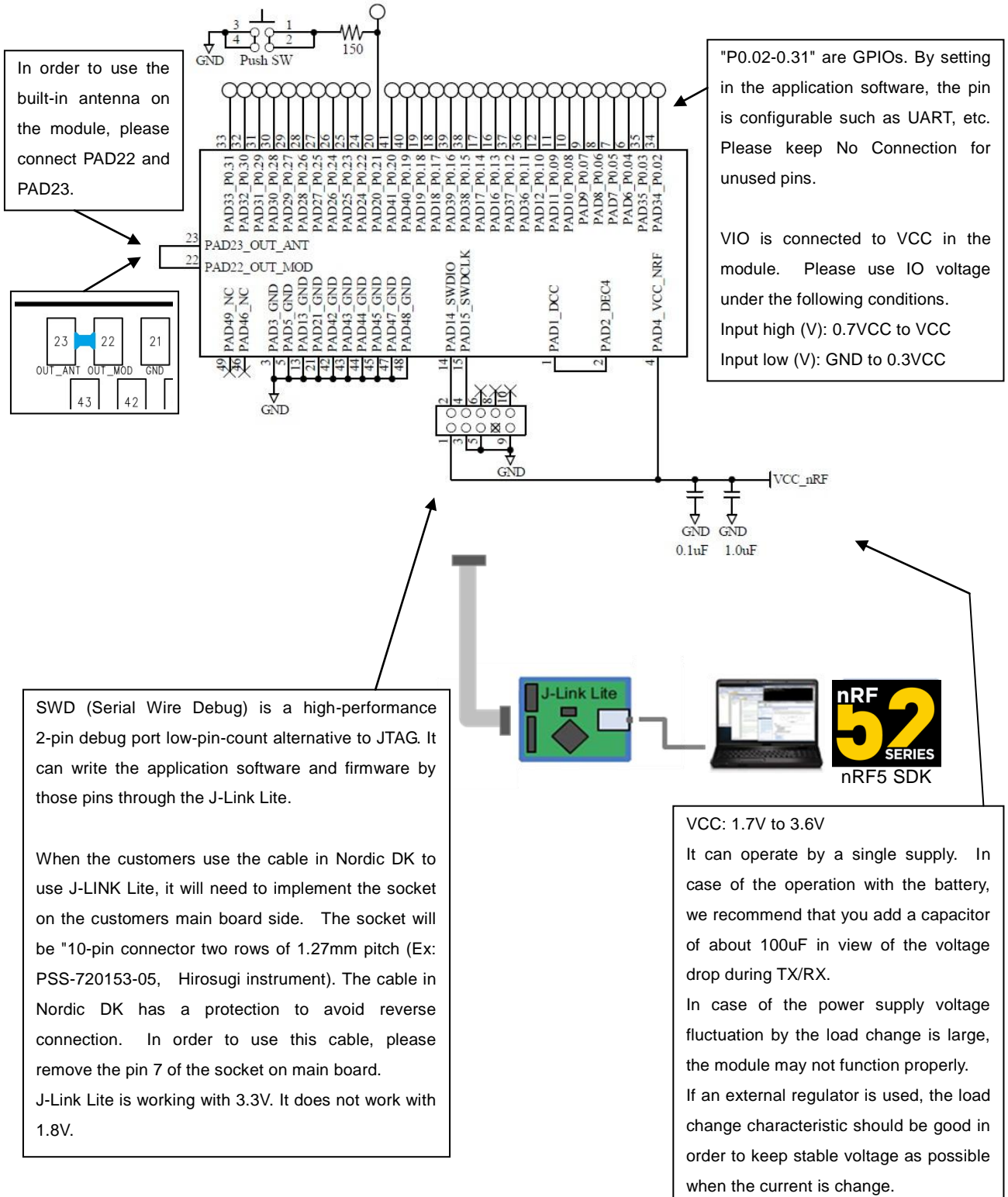

EYSHCNZXZ

TAIYO YUDEN

Control No. HD-AD-A150108 (1/3)	Control name Outline/Appearance
------------------------------------	------------------------------------

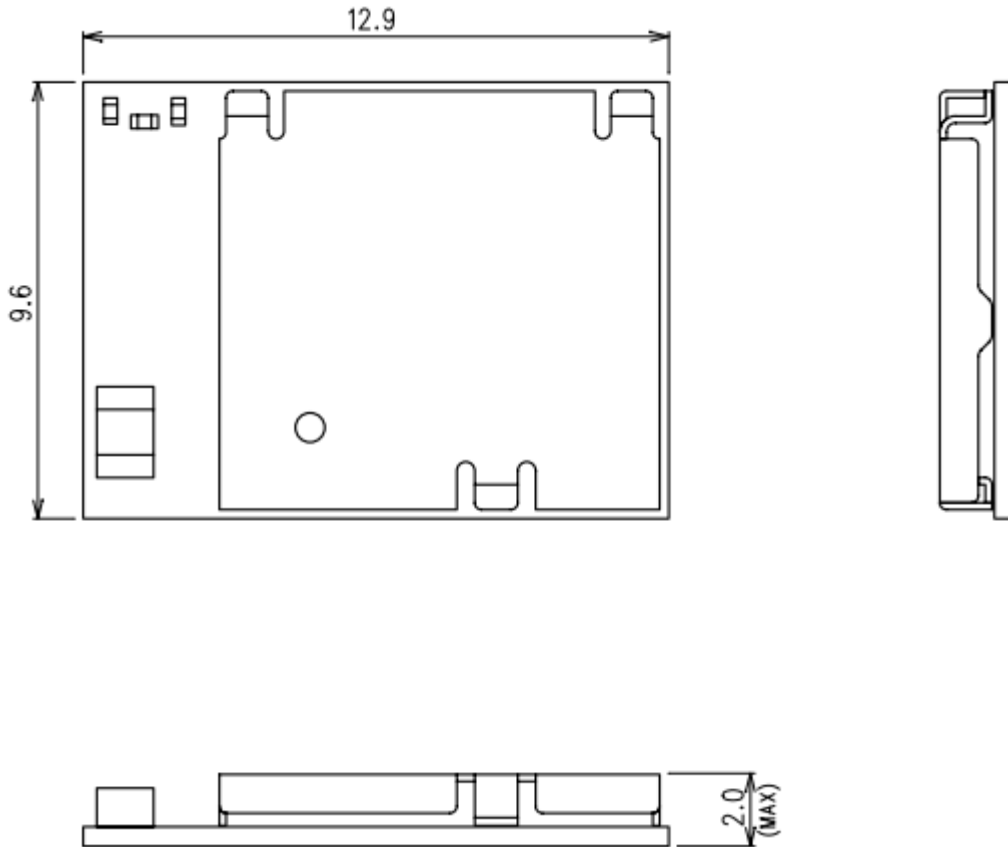

Tolerance: +/- 0.2mm

Unit : (mm)

TAIYO YUDEN

EYSHCNZZX

TAIYO YUDEN

Control No. HD-AD-A150108	(2/3)	Control name Outline/Appearance
------------------------------	-------	------------------------------------

(TOP VIEW)

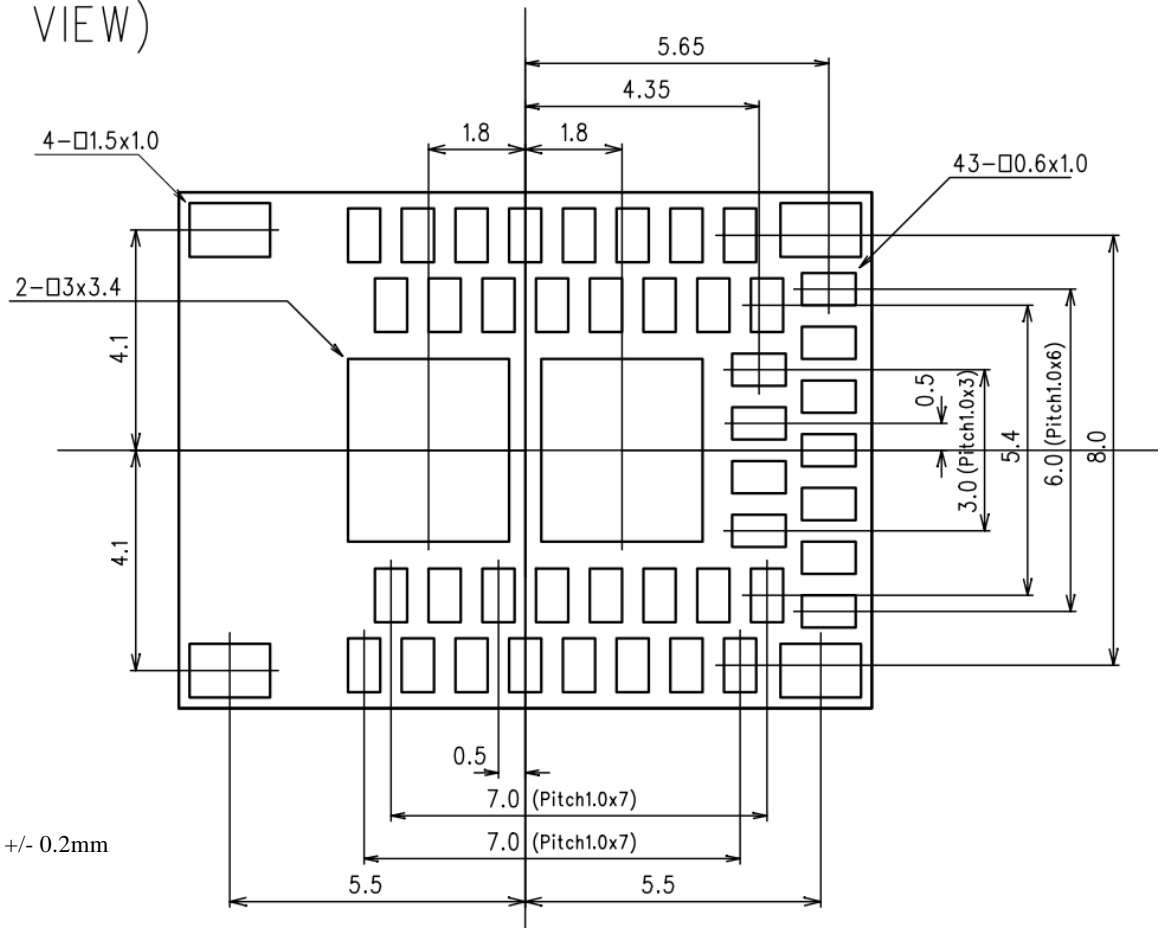

Tolerance: +/- 0.2mm
Unit: mm

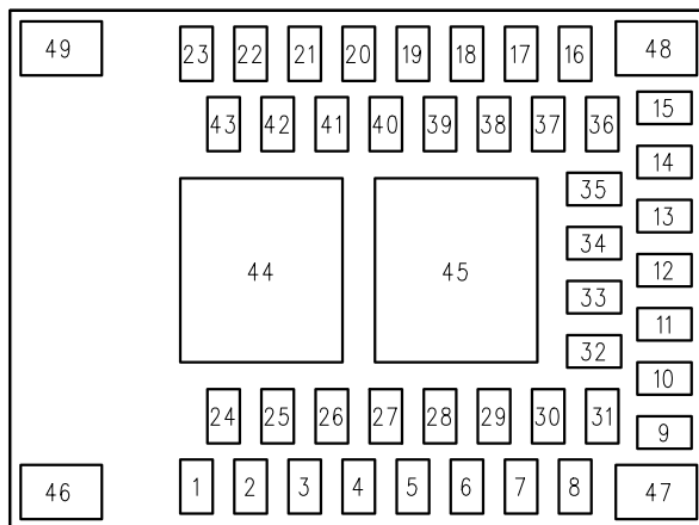

TAIYO YUDEN

EYSHCNZXZ

TAIYO YUDEN

Control No. HD-AD-A150108	(3/3)	Control name Outline/Appearance
------------------------------	-------	------------------------------------

LAND PATTERN EXAMPLE

(TOP VIEW)

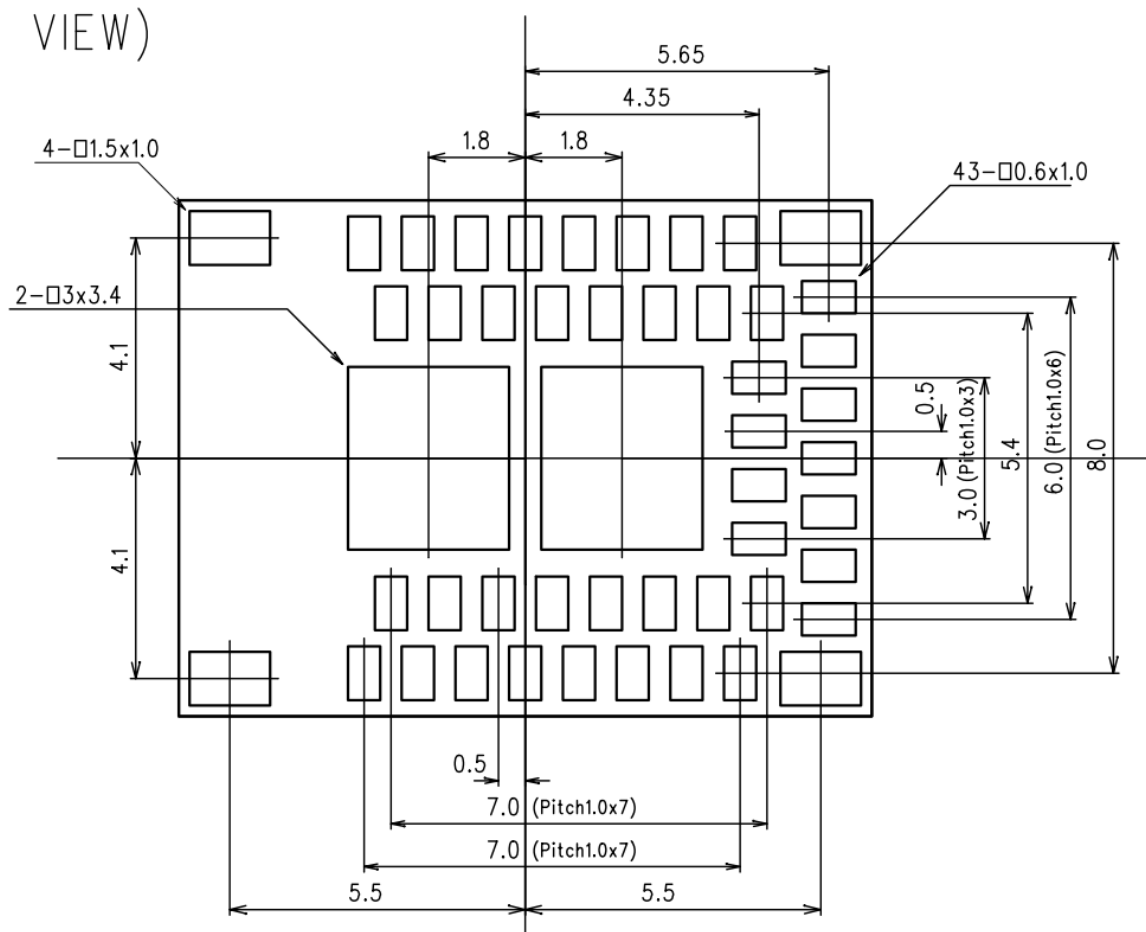

Recommended metal mask for solder printing

Pad size	Mask opening
Signal pad 43 - 0.6 x 1.0 mm	0.5 x 0.9 mm
Corner pad 4 - 1.5 x 1.0 mm	1.0 x 0.7 mm
Center pad 2 - 3.0 x 3.4 mm	2.6 x 3.0 mm

The center of each mask opening is same as the pad center.

The metal mask thickness: $t=0.1\text{mm}$

The solder volume should be same by changing the mask opening if different metal mask thickness is used.

TAIYO YUDEN

EYSHCNZXZ

TAIYO YUDEN

Control No. HD-BA-A150108	(1/2)	Control name Pin Layout
------------------------------	-------	----------------------------

Pin Descriptions

Pin	Pin name	Pin function	Description
1	DCC	Power	DC/DC converter output pin (built-in LC for DC/DC).
2	DEC4	Power	1V3 regulator supply decoupling. Input from DC/DC converter. Output from 1.3 V LDO.
3	GND	Ground	Ground pin. (0 V)
4	VCC_NRF	Power	Power supply pin.
5	GND	Ground	Ground pin. (0 V)
6	P0.04 AIN2	Digital I/O Analog input	General purpose I/O pin. SAADC/COMP/LPCOMP input.
7	P0.05 AIN3	Digital I/O Analog input	General purpose I/O pin. SAADC/COMP/LPCOMP input.
8	P0.06	Digital I/O	General purpose I/O pin.
9	P0.07	Digital I/O	General purpose I/O pin.
10	P0.08	Digital I/O	General purpose I/O pin.
11	NFC1 P0.09	NFC input Digital I/O	NFC antenna connection. General purpose I/O pin.
12	NFC2 P0.10	NFC input Digital I/O	NFC antenna connection. General purpose I/O pin.
13	GND	Ground	Ground pin. (0 V)
14	SWDIO	Digital I/O	Serial Wire Debug I/O for debug and programming
15	SWDCLK	Digital input	Serial Wire Debug clock input for debug and programming
16	P0.13	Digital I/O	General purpose I/O pin.
17	P0.14 TRACEDATA[3]	Digital I/O	General purpose I/O pin. Trace port output.
18	P0.17	Digital I/O	General purpose I/O pin
19	P0.18 TRACEDATA[0]	Digital I/O	General purpose I/O pin Trace port output.
20	P0.21 RESET	Digital I/O	General purpose I/O pin Configurable as system RESET pin.
21	GND	Ground	Ground pin. (0 V)
22	OUT_MOD	RF In/Out	RF I/O pin. It should be connected to Pin 23 OUT_ANT for normal operation.

TAIYO YUDEN

EYSHCNZXZ

TAIYO YUDEN

Control No. HD-BA-A150108	(2/2)	Control name Pin Layout
------------------------------	-------	----------------------------

Pin	Pin name	Pin function	Description
23	OUT_ANT	Antenna In/Out	Internal antenna. It should be connected to Pin 22 OUT_MOD for normal operation.
24	P0.22	Digital I/O	General purpose I/O pin.
25	P0.23	Digital I/O	General purpose I/O pin.
26	P0.24	Digital I/O	General purpose I/O pin.
27	P0.25	Digital I/O	General purpose I/O pin.
28	P0.26	Digital I/O	General purpose I/O pin.
29	P0.27	Digital I/O	General purpose I/O pin.
30	P0.28 AIN4	Digital I/O Analog input	General purpose I/O pin. SAADC/COMP/LPCOMP input.
31	P0.29 AIN5	Digital I/O Analog input	General purpose I/O pin. SAADC/COMP/LPCOMP input.
32	P0.30 AIN6	Digital I/O Analog input	General purpose I/O pin. SAADC/COMP/LPCOMP input.
33	P0.31 AIN7	Digital I/O Analog input	General purpose I/O pin. SAADC/COMP/LPCOMP input.
34	P0.02 AIN0	Digital I/O Analog input	General purpose I/O pin. SAADC/COMP/LPCOMP input.
35	P0.03 AIN1	Digital I/O Analog input	General purpose I/O pin. SAADC/COMP/LPCOMP input.
36	P0.11	Digital I/O	General purpose I/O pin.
37	P0.12	Digital I/O	General purpose I/O pin.
38	P0.15 TRACEDATA[2]	Digital I/O	General purpose I/O pin. Trace port output.
39	P0.16 TRACEDATA[1]	Digital I/O	General purpose I/O pin. Trace port output.
40	P0.19	Digital I/O	General purpose I/O pin.
41	P0.20 TRACECLK	Digital I/O	General purpose I/O pin. Trace port clock output.
42 to 45	GND	Ground	Ground pin. (0 V)
46	NC	Not Connected	Isolated pad on PCB for mechanical stability.
47 to 48	GND	Ground	Ground pin (0 V)
49	NC	Not Connected	Isolated pad on PCB for mechanical stability.

TAIYO YUDEN

Control No. HQ-BA-537	(1/2)	Control name Handling Precaution
--------------------------	-------	-------------------------------------

This specification describes desire and conditions especially for mounting.

Desire/Conditions

- (1) Environment conditions for use and storage
1. Store the components in an environment of < **40deg-C/90%RH** if they are in a moisture barrier bag packed by TAIYO YUDEN.
 2. Keep the factory ambient conditions at < **30deg-C/60%RH**.
 3. Store the components in an environment of < **25±5deg-C/10%RH** after the bag is opened.
(The condition is also applied to a stay in the manufacture process).

- (2) Conditions for handling of products

Make sure all of the moisture barrier bags have no holes, cracks or damages at receiving. If an abnormality is found on the bag, its moisture level must be checked in accordance with 2 in (2).

Refer to the label on the bag.

1. All of the surface mounting process (reflow process) must be completed **in 12 months** from the bag sea date.
2. Make sure humidity in the bag is less than **10%RH** immediately after open, using a humidity indicator card sealed with the components.
3. **All** of the surface mounting process (reflow process including rework process) must be completed in **168 hours** after the bag is opened (inclusive of any other processes).
4. If any conditions in (1) or condition 2 and 3 in (2) are not met, bake the components in accordance with the conditions at **125deg-C 24hours**
5. As a rule, baking the components in accordance with conditions 4 in (2) shall be once.
6. Since semi-conductors are inside of the components, they must be free from static electricity while handled.(<100V) Use ESD protective floor mats, wrist straps, ESD protective footwear, air ionizers etc. , if necessary.
7. Please make sure that there are lessen mechanical vibration and shock for this module, and do not drop it.
8. Please recognize pads of back side at surface mount.
9. Washing the module is not recommended. If washing cannot be avoided, please test module functionality and performance after thoroughly drying the module. We cannot be held responsible for any failure due washing the module..
10. Please perform temperature conditions of module at reflow within the limits of the following.

Please give the number of times of reflow as a maximum of 2 times.

EYSHCNZXZ

TAIYO YUDEN

Control No. HQ-BA-537	(2/2)	Control name Handling Precaution
--------------------------	-------	-------------------------------------

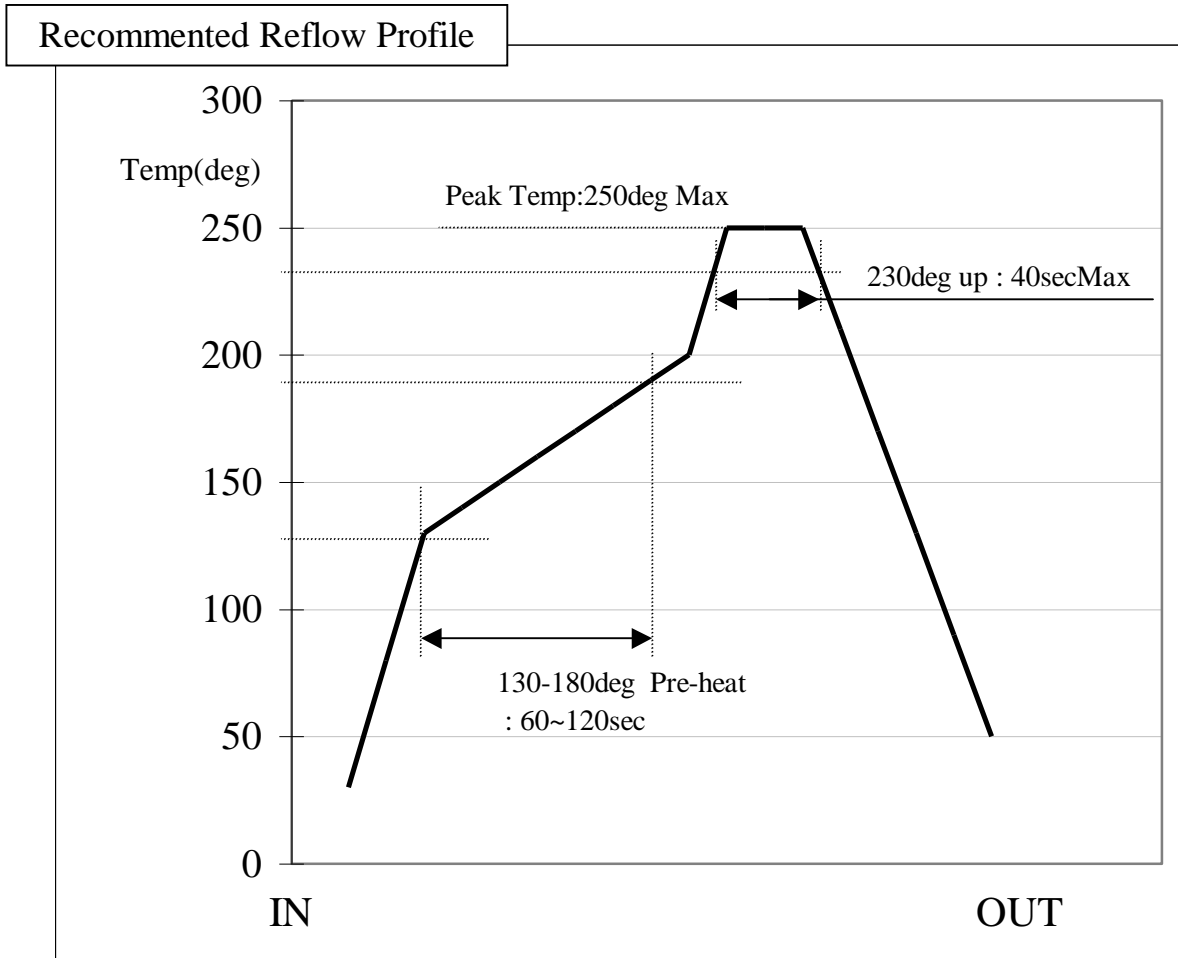

TAIYO YUDEN

Control No. HD-BB-A150108	(1/3)	Control name Packaging Specification
------------------------------	-------	---

Packaging Specification

梱包仕様

(1) Packaging Material 梱包材料

Name 部材名	Outline 概要	Materials 材質	Note 備考
Emboss エンボス	24mm wide - 12mmPitch 24mm幅 - 12mmピッチ	Conductive PS 導電性 PS	
Cover Tape カバーテープ			
Reel リール	φ 330 mm	Conductive PS 導電性 PS	
Desiccant 乾燥剤	30g×1		
Humidity indicator card 湿度インジケータ			
Aluminum moisture barrier bag アルミ防湿袋	420×460(mm)	(AS)PET/AL/NY/PE(AS)	
Label ラベル			
Corrugated cardboard box(Inner) 個装箱	339×351×74(mm)		
Corrugated cardboard box(Outer) 外装箱	369×369×277(mm)		

(2) Packaging Unit

梱包数量

Max 1000 pieces/Reel

Max 3000 pieces/Box(Outer)

(3) Packaging Figure

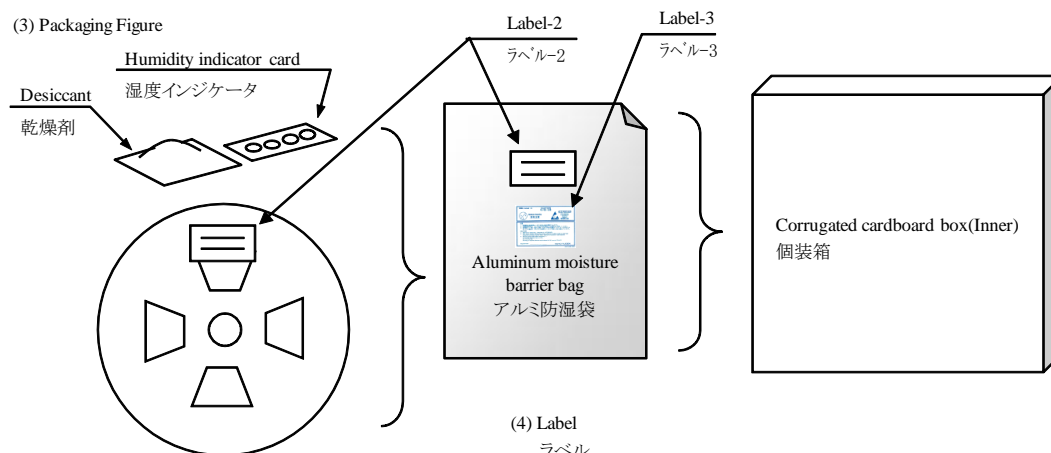

(4) Label

ラベル

Label-1

- ・CAMPAANY NAME 御社名
- ・PURCHASE ORDER 注文番号
- ・DESCRIPITON 品名
- ・QUANTITY 数量
- ・LotNo. ロット番号

Label-2

- ・PURCHASE ORDER 注文番号
- ・DESCRIPITON 品名
- ・QUANTITY 数量
- ・LotNo. ロット番号

Label-3

- CAUTION LABEL
注意ラベル
- ・MSL Level3

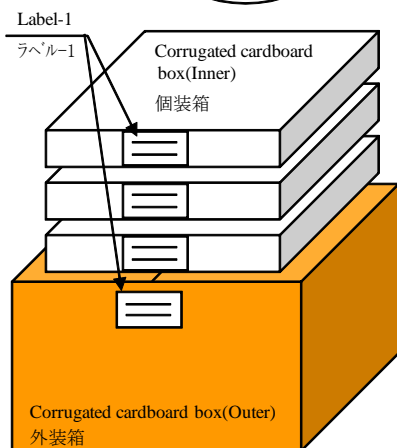

EYSHCNZXZ

TAIYO YUDEN

Control No. HD-BB-A150108	(2/3)	Control name Packaging Specification
------------------------------	-------	---

Tape specification
テーピング仕様

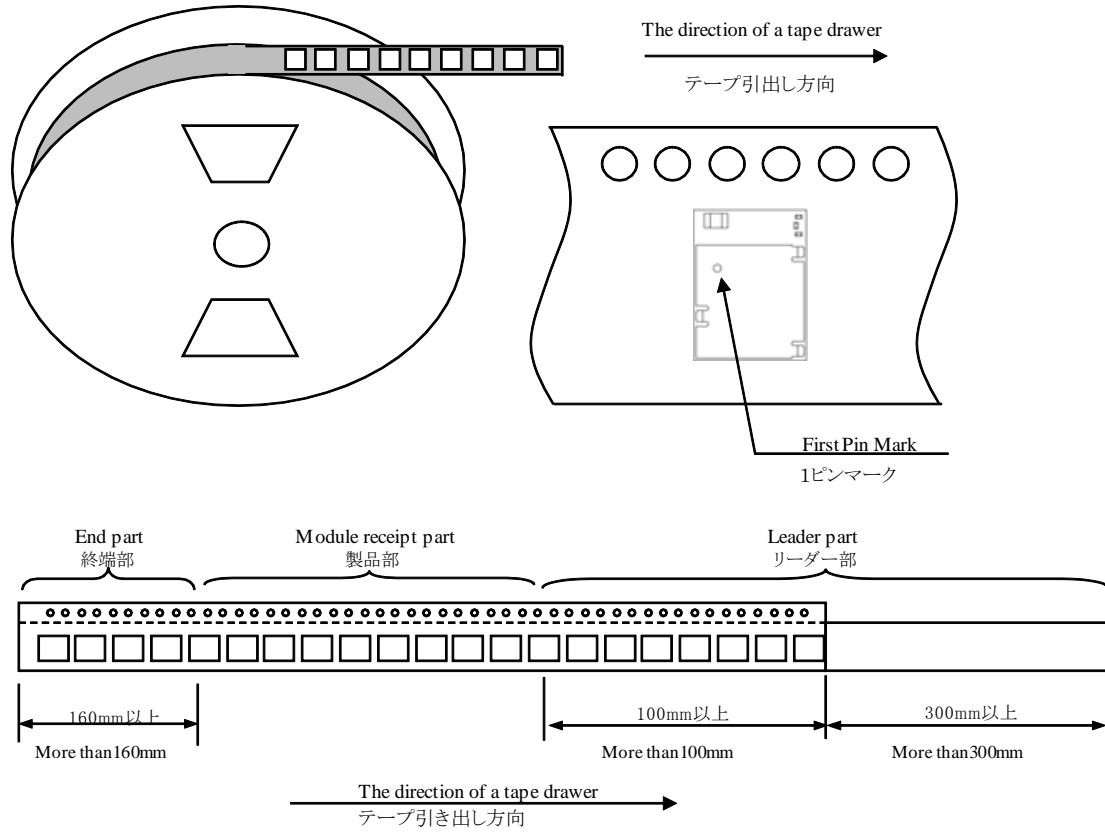

キャリアエンボス図面

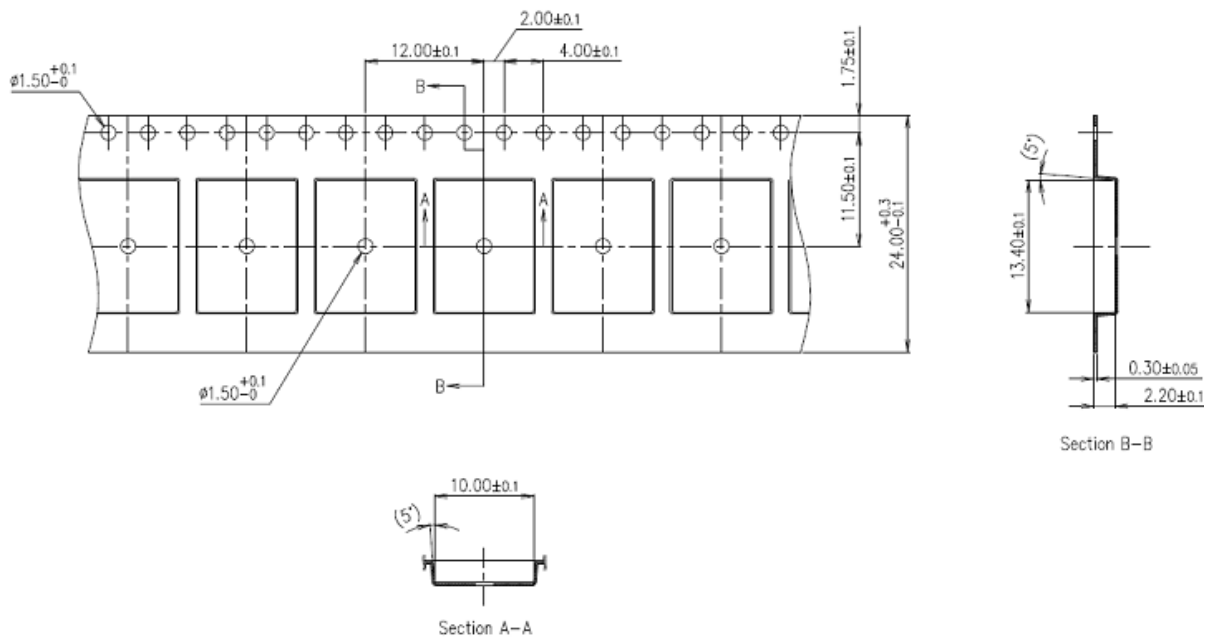

TAIYO YUDEN

EYSHCNZXZ

TAIYO YUDEN

Control No.
HD-BB-A150108

(3/3)

Control name
Packaging Specification

Reel specification
リール仕様

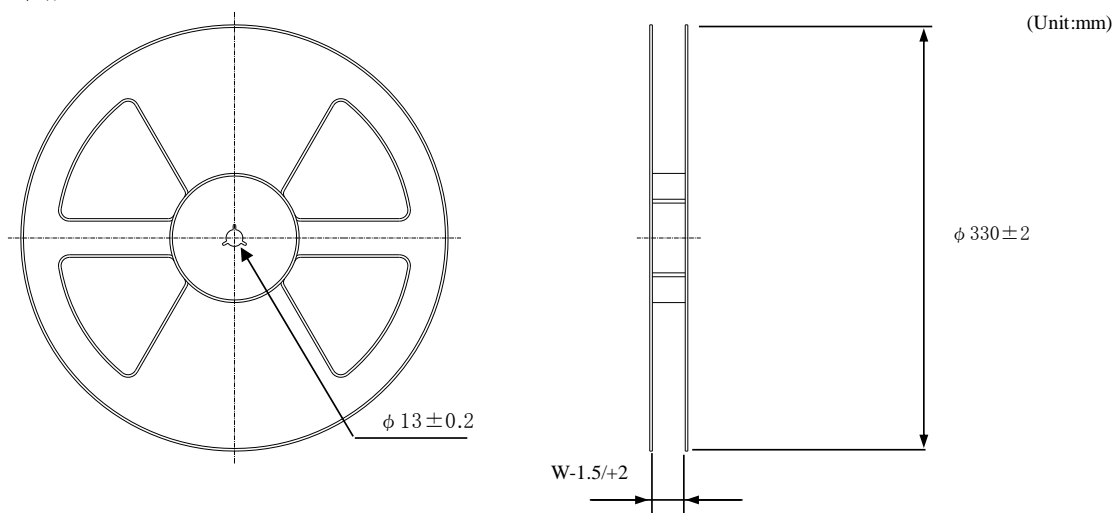

Tape wide	8mm	12mm	16mm	24mm	32mm	44mm
W	9.4mm	13.4mm	17.4mm	25.4mm	33.4mm	45.4mm

Taping performance
テーピング性能

Both of an embossing tape top cover tape bear this, when the power of 10N is applied in the direction of a drawer.
・エンボステープ、トップカバーテープともに、引き出し方向に10Nの力を加えた場合に、これに耐えること。

The exfoliation adhesion of a top cover tape is the intensity of 0.1~1.3N.
(The angle to pull is 165~180 degrees. The speed to pull is 300 mm/min.)

・トップカバーテープの剥離強度は、角度165~180度に保ち、300mm/minのスピードでトップカバーテープを引っ張ったとき、0.1~1.3Nとする。

Note
備考

Lack of the parts in 1 reel is with two or less pieces.

1リール中の部品の欠落は2個までとします。(ラベル表示数量と梱包数は同じです。欠落とはテープ内でのモジュール抜けが2個まで許容させていただくという意味になります。)

MSL Level 3 Under control

MSL はレベル3 で管理しています。

TAIYO YUDEN

Control No. (1/3)	Control name Antenna application note
--------------------------	--

Keep-out area

In order to keep the antenna performance on the module, please do not place any components, ground of main board, signal line, conductive plating in Keep-out area except for the lands (46pin, 49pin). The purpose of lands (46pin, 49pin) are for mounting module. Please place lands only in the keep-out area. (Please do not connect pattern line to those lands.)

Keep-out area will be applicable in all layers of the customer's substrate also.

Please consider on the occasion of pattern design.

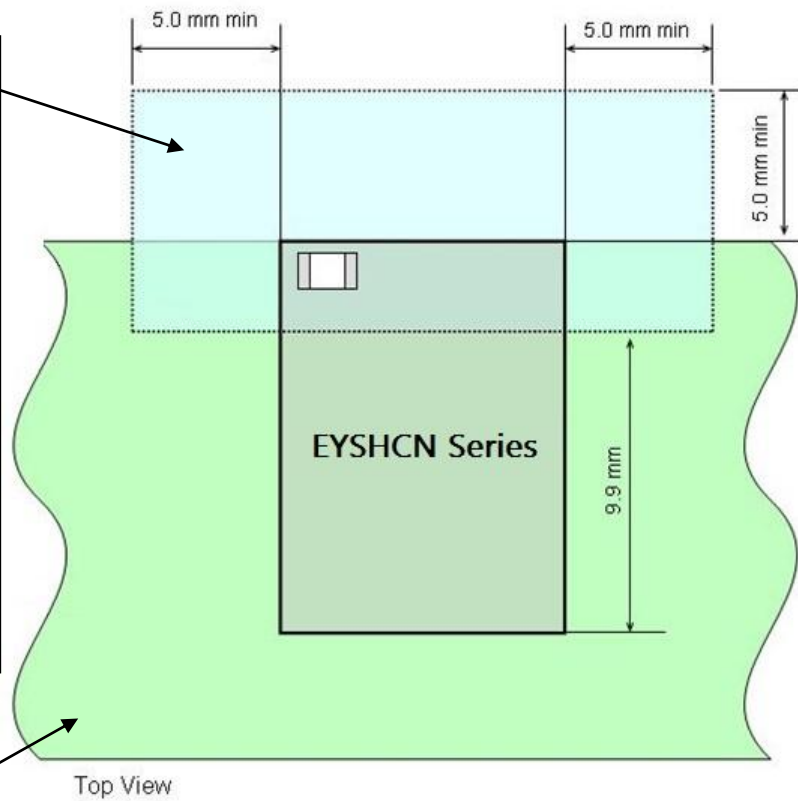

Main board of the customer's product.

Control No. (2/3)	Control name Antenna application note
--------------------------	--

Recommended arrangement of the module

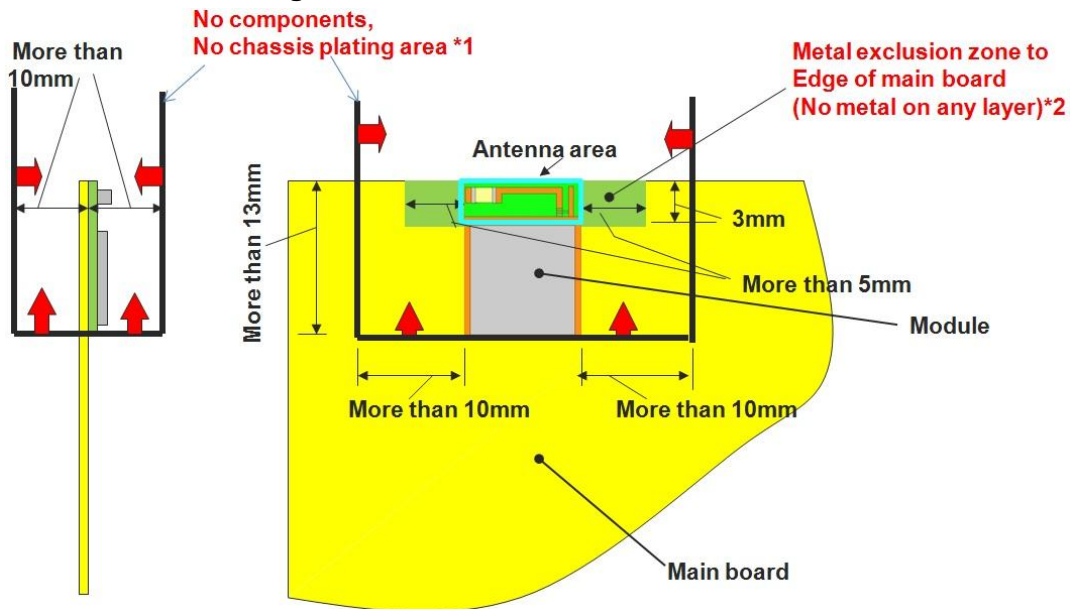

- *1 Please do not place any board, signal line and metal chassis as possible except main board. Mounting the components in *1 area on the main board is allowed in keeping with next item *2.
- *2 This area is routing prohibited area on the main board. Please do not place Copper on any layer. Please remain FR-4 dielectric material. The antenna is tuned with the FR-4.

Example layout on main board



Control No. (3/3)	Control name Antenna application note
--------------------------	--

Antenna arrangement near resin

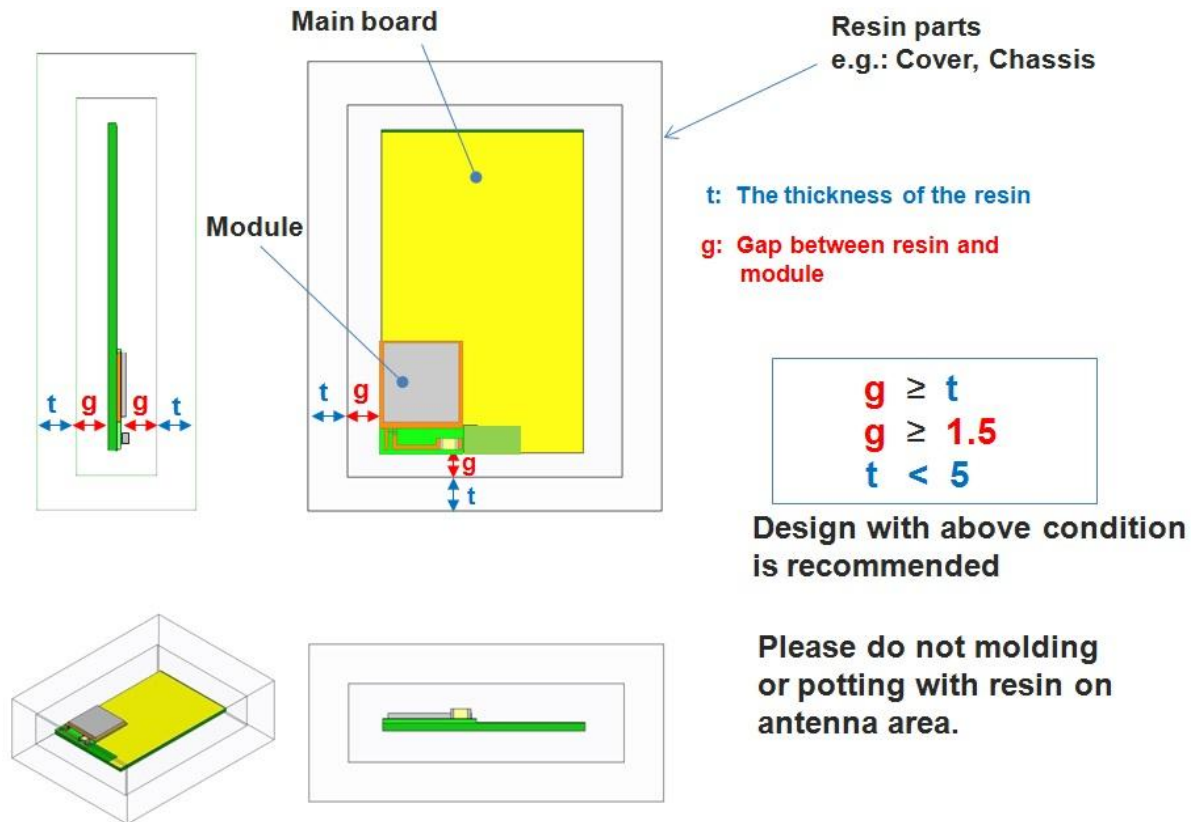

Control No. (1/1)	Control name Design guide
----------------------	------------------------------

1. Power Up Sequence

VCC_NRF power supply rise time (0V to 1.7V) must not exceed 60ms.

2. Recommended Power Circuit

VCC_NRF is the main power supply (1.7 – 3.6V) for this module. The supply voltage range of VCC_NRF is 1.7V to 3.6V in both of LDO and DCDC mode. In case of the power supply voltage fluctuation by the load change is large, the module may not function properly. If an external regulator is used, the load change characteristic should be good in order to keep stable voltage as possible when the current is change.

3. Battery operation

When using a small battery (e.g. CR2032), a large capacitor (e.g.100uF low leakage capacitor) should be placed near the battery. This will reduce the voltage drop especially when the module is operated at low temperatures

4. Pattern Design Guide

4-1. Power Supply System

Power supply bypass capacitors should be placed close to the VCC_NRF pin of the module. The VCC_NRF trace should be greater than 0.5mm and a bigger a via diameter is recommended.

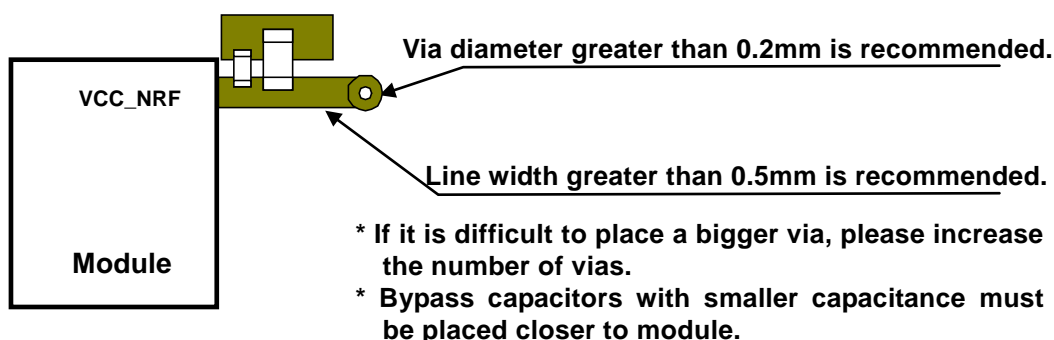

4-2. Bypass Capacitor Layout

A parallel combination of a small capacitance (about 10pF) and a large capacitance (1uF to 10uF) is recommended for bypass capacitors. The GND of the bypass capacitor must be placed close to an adjacent module GND to ensure the shortest closed loop.

4-3. GND Pattern

Power supply bypass capacitor GND should be placed in proximity of module GND. Wide GND area must be provided to ensure isolation for each layer.

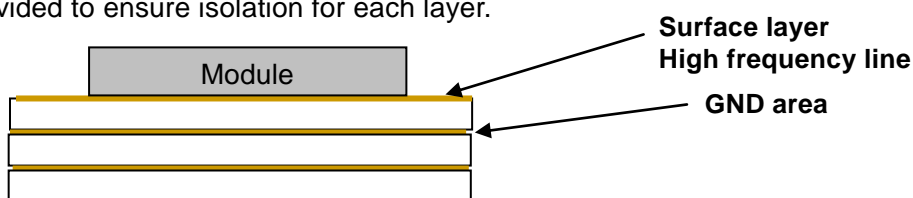

GND pattern of each layer should be connected to GND area with large number of via.