



Si5100/Si5110-EVB

Evaluation Board Set for Si5100 and Si5110 OC-48/STM-16 SONET/SDH TRANSCEIVERS

Description

The Si5100-EVB and Si5110-EVB motherboard/daughter card sets provide a platform for testing and characterizing Silicon Laboratories' Si5100/Si5110 SiPHY™ OC-48/STM-16 SONET/SDH Transceiver. The Si5100 and Si5110 transceiver devices provide full-duplex operation at serial data rates up to 2.7 Gbps. The transceiver device is mounted on the EVB daughter card. The high-speed serial signals are accessed via SMA connectors on the daughter card itself. The low-speed parallel data channels are routed from the daughter card to the motherboard through the industry-standard 300-pin meg-array connector.

The included transceiver loopback motherboard provides a hardware connection between the transceiver low-speed parallel data outputs, RXDOUT, and the transceiver low-speed parallel data inputs, TXDIN. Test points are provided on the motherboard to allow monitoring of the parallel data channels. The clock signals associated with the low-speed data channels are routed to SMA connectors on the loopback motherboard. Static control and status signals are routed to standard 100-mil center posts.

An optional full-duplex motherboard is also available for the transceiver daughter card. The full-duplex motherboard also utilizes the industry-standard 300-pin meg-array connector to allow attachment of the daughter card. The full-duplex motherboard routes all of the transceiver low-speed parallel data outputs and inputs to standard SMA connectors. The optional full-duplex motherboard is useful when connecting the transceiver device to a parallel bit error rate tester (ParBERT), or in other applications that require full access to the low-speed parallel data channels.

Features

- Separate supply connections for VDD (1.8 V) and VDDIO (1.8 V or 3.3 V) allow LVTTTL I/Os to be powered at either 1.8 V or 3.3 V.
- Control inputs are jumper configurable.
- Status outputs brought out to headers for easy access.
- Potentiometers provided for controlling analog inputs.
- Loopback Motherboard (included) provides hardware path between low-speed parallel data outputs RXDOUT and low-speed parallel data inputs TXDIN.
- Optional full-duplex motherboard provides access to all low-speed parallel data outputs and inputs via SMA connectors.

Si5100/Si5110-EVB

Motherboard/Daughter Card Set

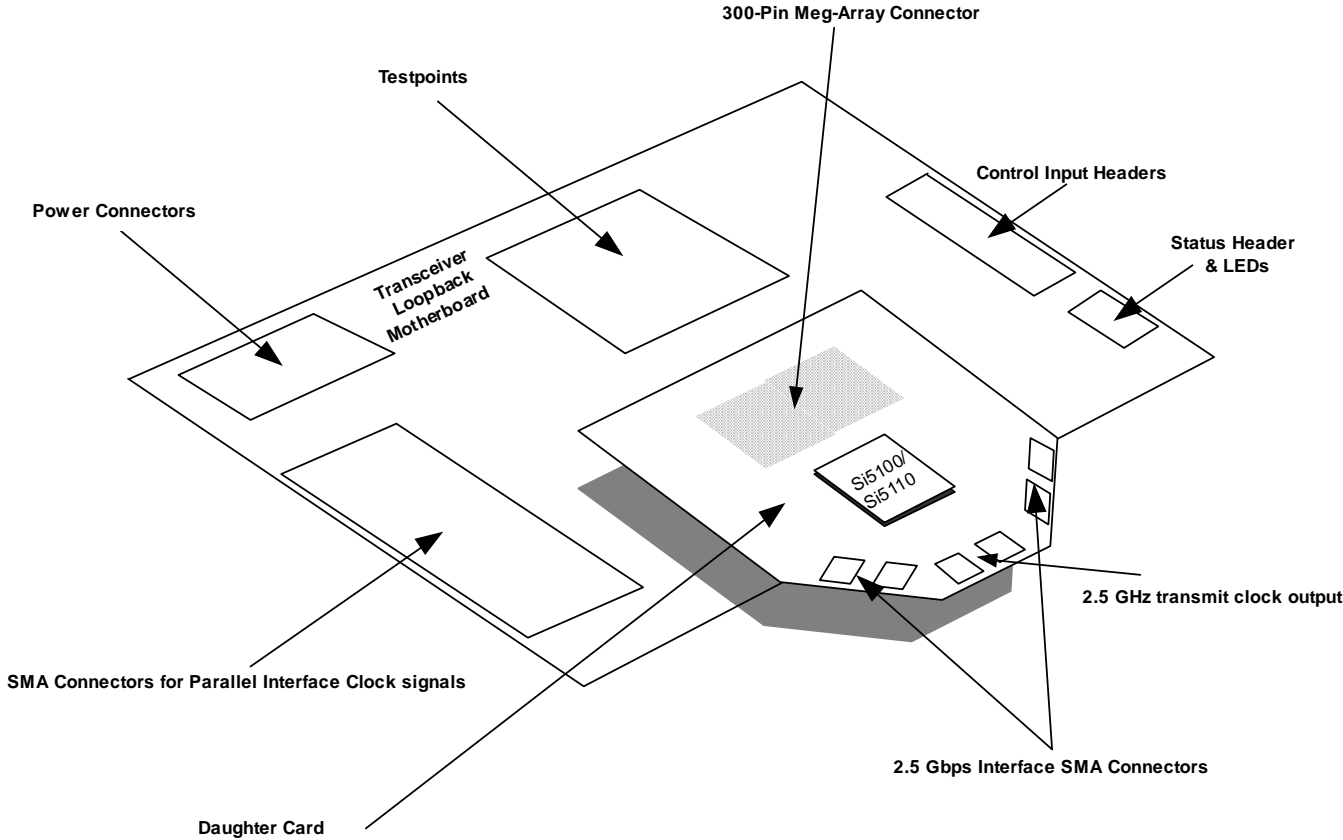

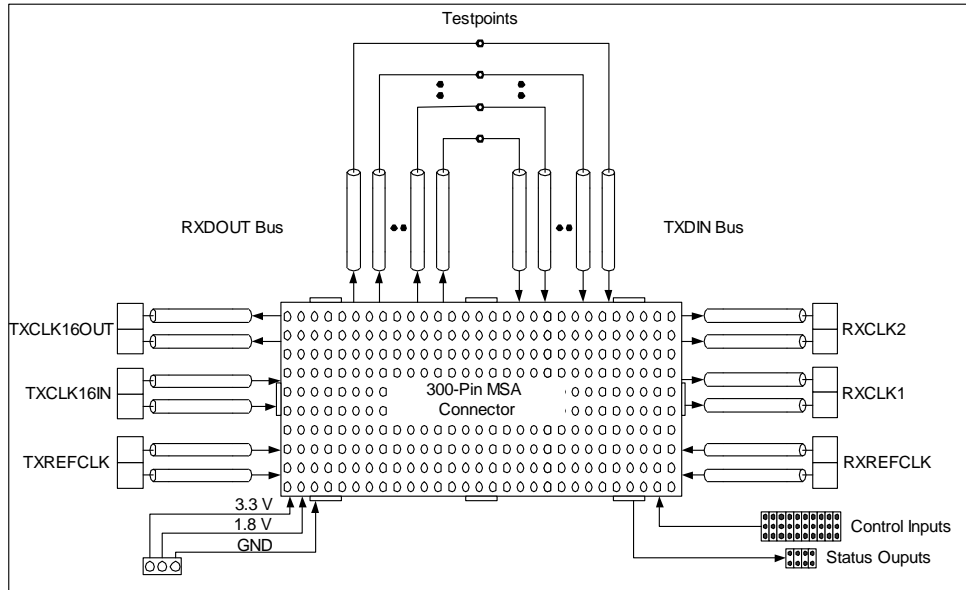

Figure 1. Loopback Motherboard Functional Block Diagram

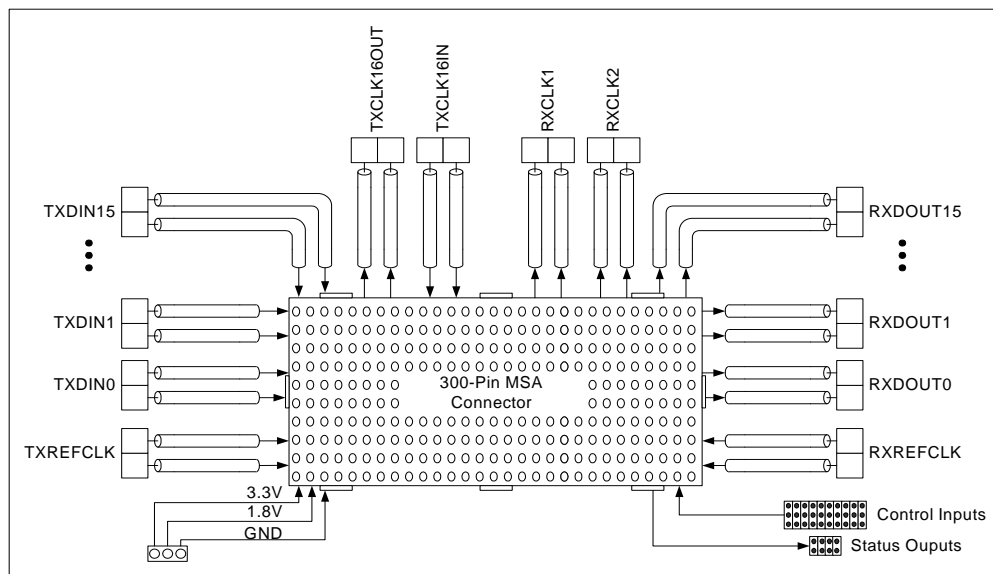

Figure 2. Optional Full-Duplex Motherboard Functional Block Diagram

Si5100/Si5110-EVB

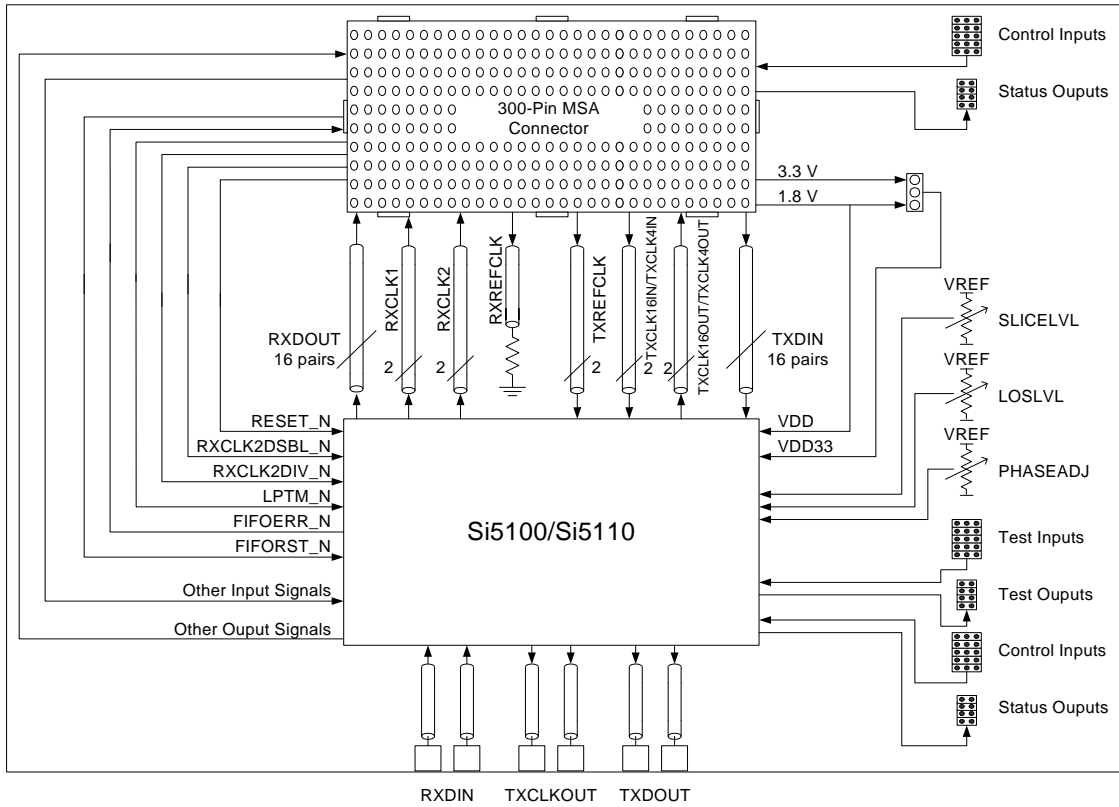

Figure 3. Daughter Card Functional Block Diagram

Functional Description

The Si5100-EVB and Si5110-EVB motherboard and daughter card sets simplify characterization of the OC-48/STM-16 and FEC transceiver devices by providing convenient access to the device I/Os. Device performance can be evaluated in various modes by following the “Basic Test Setup” section.

Power Supply

The transceiver device can be powered from a single 1.8 V supply or separate 1.8 V and 3.3 V supplies. When the additional 3.3 V supply is applied, the status outputs are LVTTTL compatible. The daughter card can be configured for either mode of operation by setting the VDD_IO SEL jumper as shown in Figure 4.

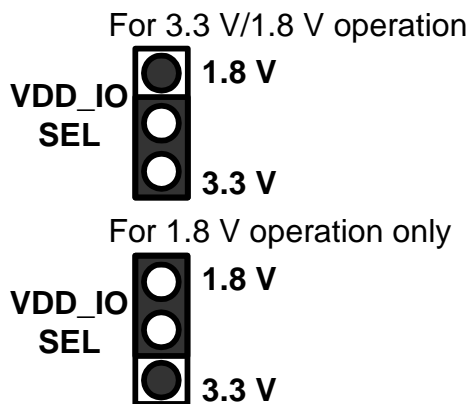

Figure 4. VDD_IO Selection Jumpers

Control Inputs

The device control inputs are located on the motherboard and daughter card. Signals with equivalent module functions are routed to the motherboard header, JP1. Signals specific to the transceiver are routed on the daughter card to jumpers JP1 and JP2. In both cases, the signal is routed to the center pin of a three pin group where the adjacent pins are power and ground. The device inputs are pulled high or low so that leaving a signal unconnected will not harm the device.

Status Outputs

The device status outputs are located on the motherboard and daughter card. Signals with equivalent module functions are routed to the motherboard header, JP2. Signals specific to the transceiver are routed on the daughter card to headers JP3 and JP4. In both cases, the signal is routed to a header pin adjacent to a ground pin.

Data I/O Signals

The serial 2.5 Gbps data and 2.5 GHz clock paths are routed as coplanar differentially-coupled microstrip transmission lines on the daughter card. These three signals (RXDIN, TXCLKOUT, and TXDOUT) are ac coupled to standard SMA jacks for ease in connection to industry standard test equipment. Take care when connecting cables to these jacks. Use a standard SMA torque wrench to minimize reflections at the cable-to-jack interface. Finally, match all differential connections in length to minimize phase differences between the positive and negative terminals.

Differential Parallel Data and Clock I/O Signals

The differential parallel data lines are routed through the 300-pin meg-array connector to the motherboard. The standard loopback motherboard directly couples the RXDOUT bus to the TXDIN bus. The optional full-duplex motherboard directly couples the RXDOUT and TXDIN buses to standard SMA jacks for connection to industry standard test equipment.

Slice Level, Loss-of-Signal Level, and Phase Adjust

Voltages present at the Slice Level (SLICELVL), Loss-of-Signal Level (LOSLVL) and Phase Adjust (PHASEADJ) pins can be used to adjust the data slicing level, the loss-of-signal alarm level, and the sampling phase position, respectively. Because these inputs are high impedance, simple turn-based potentiometers are used to apply the control voltage. The Si5100-EVB provides 50 k Ω potentiometers for each of these inputs: potentiometer R16 sets the voltage applied to the SLICELVL pin; R14 sets the voltage applied to the LOSLVL pin, and R15 sets the voltage applied to the PHASEADJ pin. The Si5110-EVB also provides 50 k Ω potentiometers for each of these inputs. Potentiometer R5 sets the voltage applied to the SLICELVL pin; R3 sets the voltage applied to the LOSLVL pin, and R4 sets the voltage applied to the PHASEADJ pin. The potentiometers are connected so the voltage applied varies from GND to VREF. Refer to the device data sheet for details on the operation of these inputs.

Basic Test Setup

The configurations listed in Tables 1 and 3 allow easy setup of the transceiver evaluation system for operation in the line loopback, full duplex, or diagnostic loopback modes. Other configurations are supported; however, operation should first be verified in one of these modes in order to minimize the number of unknown variables.

Si5100/Si5110-EVB

Line Loopback

When configured in line-loopback mode, the device passes the received/recovered data and timing to the transmitter. The transmitter buffers the data through the FIFO and filters the jitter using the loop-bandwidth selected by BWSEL[1:0]. Operation in line loopback mode is depicted in Figure 5. Jumper settings for line loopback mode are given in Tables 1, 3 (Si5100), and 4 (Si5110). This mode of operation is attainable with both versions of the motherboard.

Full-Duplex

This mode is identical to normal operation of the device in a system. TX and RX can be asynchronous (up to ± 300 ppm) so all timing is independent. TXCLK16IN is chosen as the transmitter CMU reference clock via the REFSEL pin. Operation in full-duplex mode is depicted in Figure 6. Jumper settings for full-duplex mode are given in Tables 1, 3 (Si5100), and 4 (Si5110). If the loopback motherboard is used, the full-duplex mode effectively becomes an external loopback mode, and RXCLK1 should be connected to TXCLK16IN/TXCLK4IN to clock in the data.

Diagnostic Loopback (Parallel Side Loopback)

This mode passes the data present on the transmit parallel inputs (TXDIN[15:0] for Si5100; TXDIN[3:0] for Si5110) to the receive parallel data outputs (RXDOUT[15:0] for Si5100; RXDOUT[3:0] for Si5110). TXCLK16IN/TXCLK4IN is chosen as the transmitter CMU reference clock via the REFSEL pin. Operation in diagnostic loopback mode is depicted in Figure 7. Jumper settings for diagnostic loopback mode are given in Tables 2, 3 (Si5100), and 4 (Si5110). The full-duplex motherboard is required for this mode.

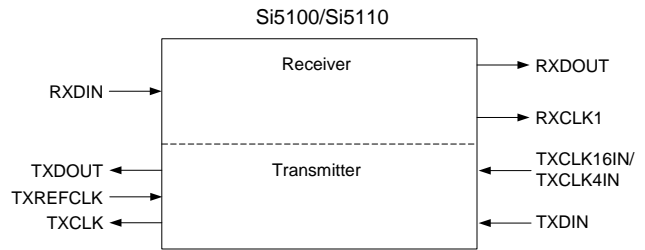

Figure 6. Full Duplex

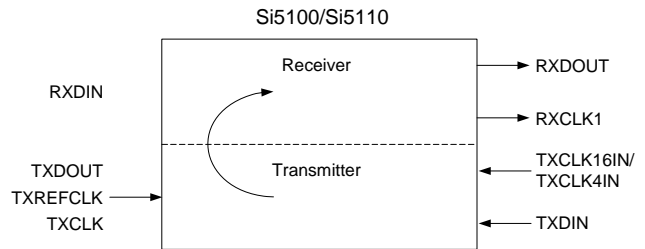

Figure 7. Diagnostic Loopback

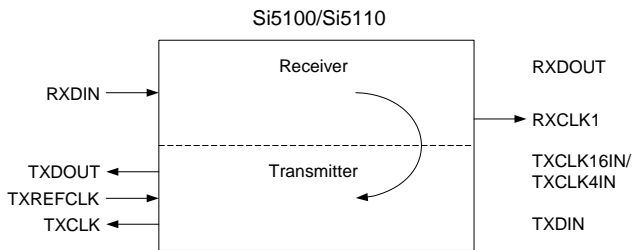

Figure 5. Line Loopback

Both the motherboard and daughter card are placed in line loopback mode before shipment to customers.

Table 1. Loopback Motherboard Setup

Header—Pin	Signal Name	Line Loopback	Asynchronous TX/RX
JP10—2	Voltage Select	3.3 V	3.3 V
JP1—14	RXCLK1DSBL_N	high	high
JP1—11	LTR_N	high	high
JP1—8	RXSQLCH_N	low	high
JP1—5	RXCLK2DIV_N	don't care	don't care
JP1—2	RXCLK2DSBL_N	don't care	don't care
JP2—5	TXREFRATE	high	high
JP2—2	TXRESET_N	high	high
JP3—8	DLBK_N	high	high
JP3—5	LLBK_N	low (enables line loopback)	high
JP3—2	LPTM_N	high	high
JP7—5	RXREFRATE	open	open
JP7—2	RXRESET_N	high	high
JP6—4	FIFORST_N	tie to FIFOERR	tie to FIFOERR

Table 2. Full-Duplex Motherboard Setup

Header—Pin	Signal Name	Line Loopback	Asynchronous TX/RX	Diagnostic Loopback
JP8—2	Voltage Select	3.3 V	3.3 V	3.3 V
JP1—14	RXCLK1DSBL_N	high	high	high
JP1—11	LTR_N	high	high	high
JP1—8	RXSQLCH_N	low	high	high
JP1—5	RXCLK2DIV_N	don't care	don't care	don't care
JP1—2	RXCLK2DSBL_N	don't care	don't care	don't care
JP2—5	REFRATE	high	high	high
JP2—2	RESET_N	high	high	high
JP3—8	DLBK_N	high	high	low
JP3—5	LLBK_N	low (enables line loopback)	high	high
JP3—2	LPTM_N	high	high	high
JP7—5	Si5530 REFRATE	open	open	open
JP7—2	Si5530 RESET_N	high	high	high
JP6—4	FIFORST_N	tie to FIFOERR	tie to FIFOERR	tie to FIFOERR

Table 3. Si5100 Daughter Card Setup

Header—Pin	Signal Name	Line Loopback	Asynchronous TX/RX	Diagnostic Loopback
JP1—20	BWSEL0	11	11	11
JP1—23	BWSEL1	(for widest CMU loop bandwidth)	(for widest CMU loop bandwidth)	(for widest CMU loop bandwidth)
JP1—17	REFSEL	high	high	high
JP1—14	MODE16	high	high	high
JP1—11	TXCLKDSBL	low	low	low
JP1—8	TXMSBSEL	low	low	low
JP1—5	TXSQLCH_N	high	high	high
JP1—2	RXMSBSEL	low	low	low

Note: Jump the VDD_IO selection jumper toward the 3.3 V side.

Table 4. Si5110 Daughter Card Setup

Header—Pin	Signal Name	Line Loopback	Asynchronous TX/RX	Diagnostic Loopback
JP1—20	BWSEL0	11 (for widest CMU loop bandwidth)	11 (for widest CMU loop bandwidth)	11 (for widest CMU loop bandwidth)
JP1—23	BWSEL1			
JP1—17	REFSEL	high	high	high
JP1—14	TXCLKDSBL	low	low	low
JP1—11	TXMSBSEL	low	low	low
JP1—8	TXSQLCH_N	high	high	high
JP1—5	SLICEMODE	low	low	low
JP1—2	RXMSBSEL	low	low	low

Note: Jump the VDD_IO selection jumper toward the 3.3 V side.

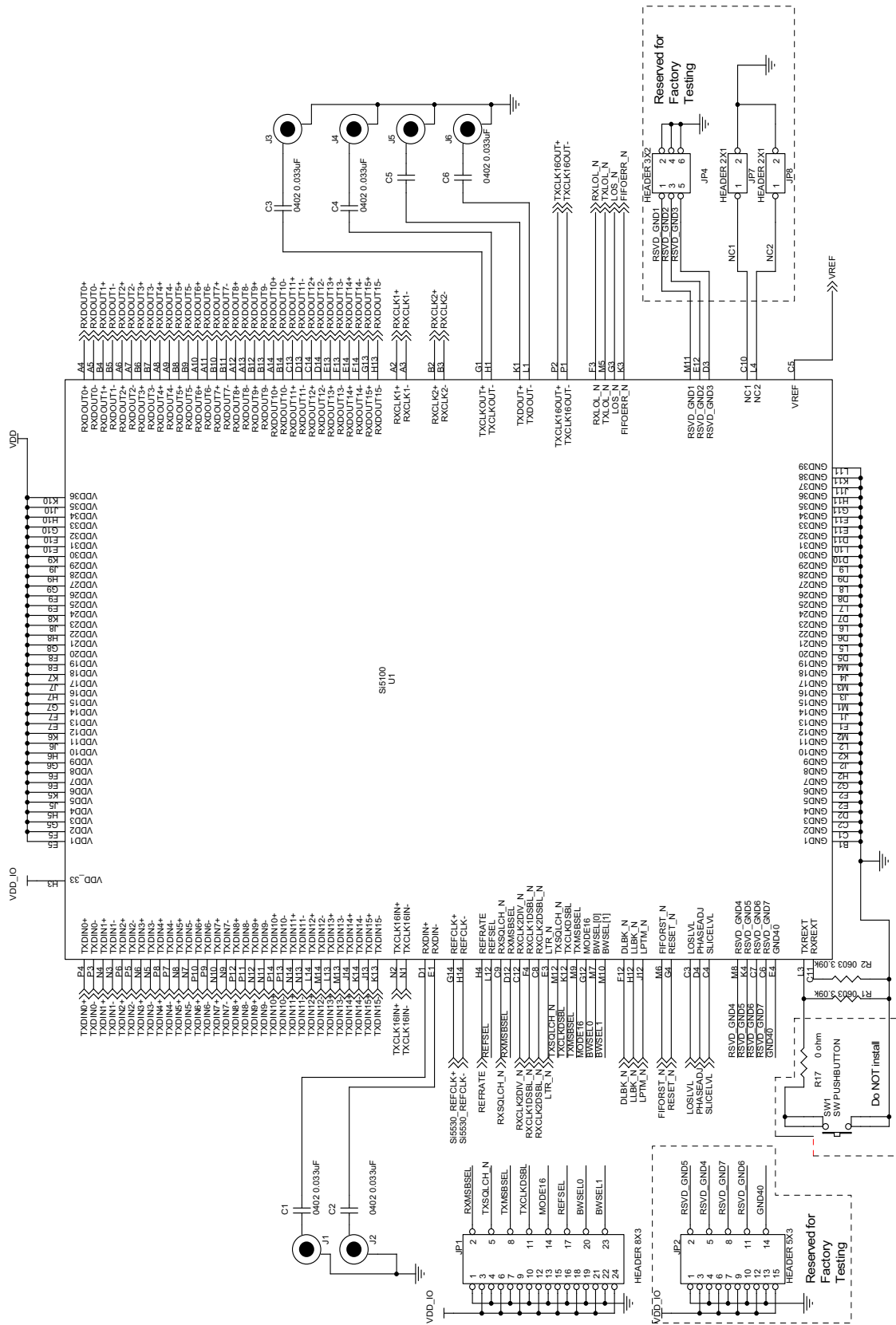

Figure 8. Si5100-EVB Daughter Card Schematic (page 1 of 3)

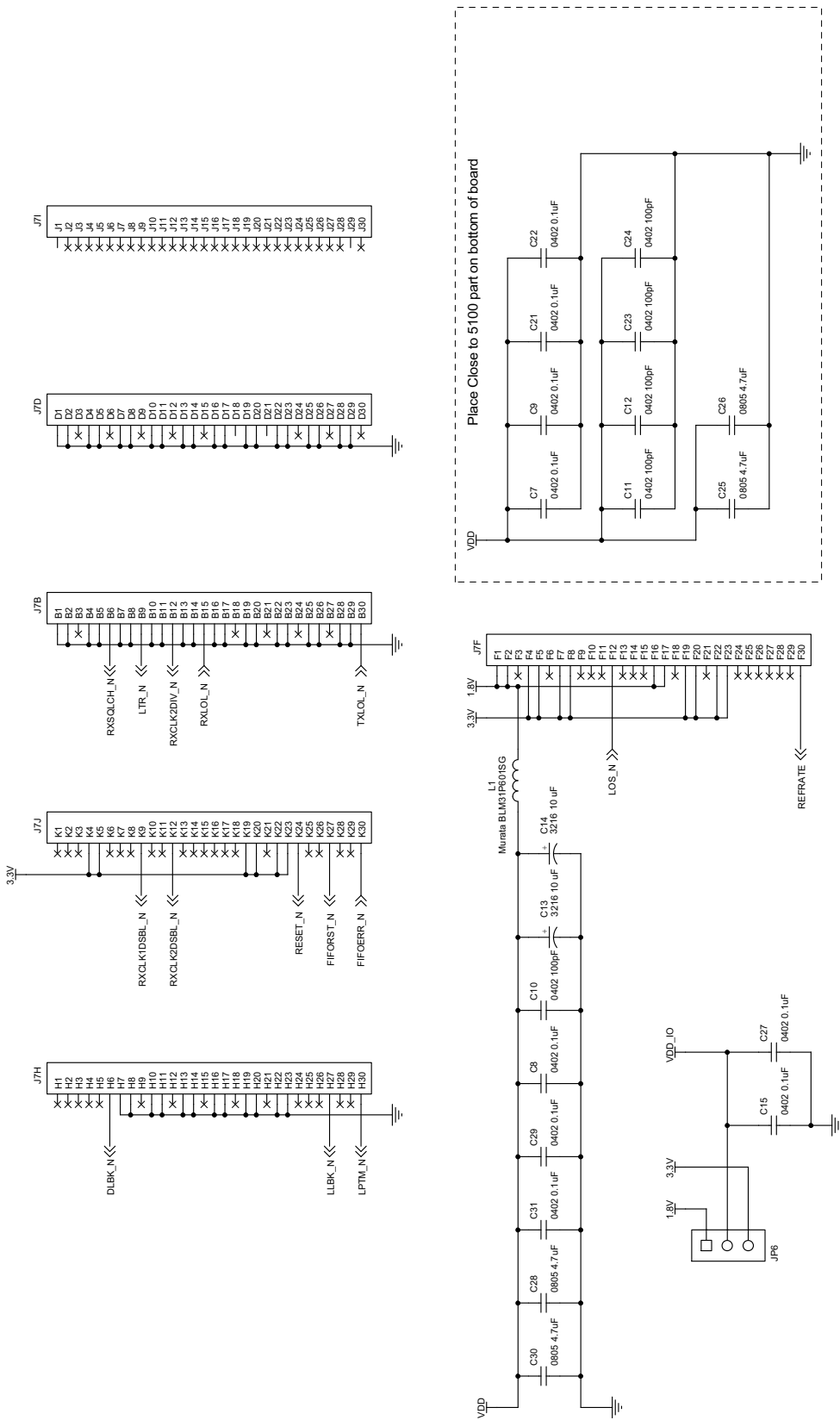

Figure 9. Si5100-EVB Daughter Card Schematic (page 2 of 3)

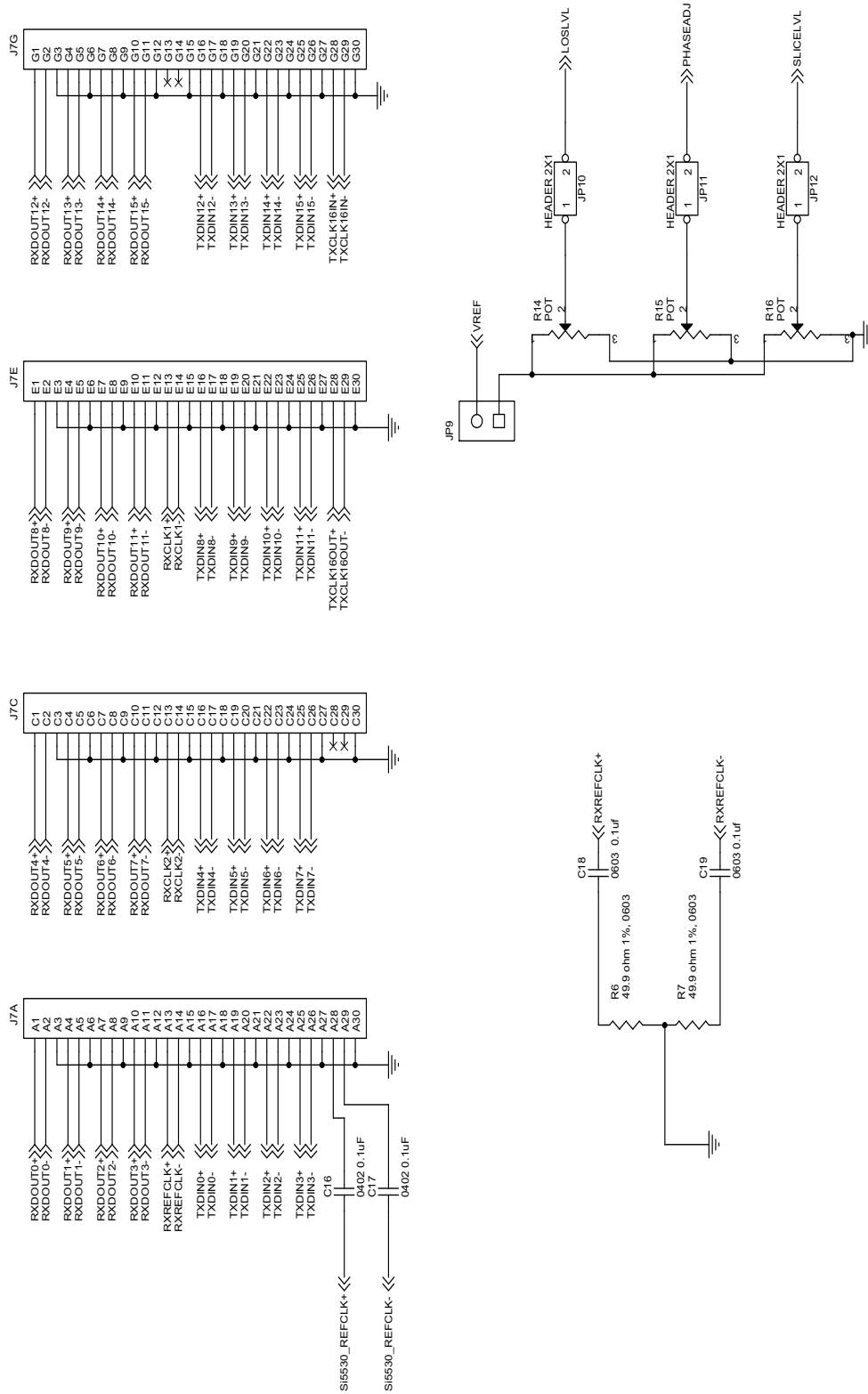

Figure 10. Si5100-EVB Daughter Card Schematic (page 3 of 3)

Si5100/Si5110-EVB

Bill of Materials: Si5100-EVB Daughter Card Assembly Revision D-01

Si5100EVB Assy Rev D-01 BOM			
Reference	Description	Manu Number	Manufacturer
C1,C2,C3,C4,C5,C6	CAP, SM, 0.033 uF, 0402	C0402X7R160333KNE	VENKEL
C7,C8,C9,C15,C16,C17,	CAP, SM, 0.1 uF, 0402	C0402X7R160104KNE	VENKEL
C21,C22,C27,C29,C31			
C10,C11,C12,C23,C24	CAP, SM, 100 pF, 0402	C0402C0G500-101JNE	VENKEL
C14,C13	CAP, SM, 10 uF, TANTALUM, 3216	TA010TCM106KAR	VENKEL
C18,C19	CAP, SM, 0.1 uF, 0603	C0603X7R160-104KNE	VENKEL
C25,C26,C28,C30	CAP,SM,4.7UF,6.3V,X7R,0805	CEJMK212BJ475KG-T	TAIYO YUDEN
JP1	CONNECTOR, HEADER, 8X3	2380-6121TN or 2340-6111TN	3M
JP2	CONNECTOR, HEADER, 5X3	2380-6121TN or 2340-6111TN	3M
JP4	CONNECTOR, HEADER, 3X2	2380-6121TN or 2340-6111TN	3M
JP6	CONNECTOR, HEADER, 3X1	2380-6121TN or 2340-6111TN	3M
JP7,JP8,JP9,JP10,JP11,	CONNECTOR, HEADER, 2X1	2380-6121TN or 2340-6111TN	3M
JP12			
J1,J2,J3,J4,J5,J6	CONNECTOR, SMA, NOTCH MOUNT	82 SMA-S50-1-45/111 NE	HUBER SUHNER
J7	CONN,SM,RECPT,MEGARRAY,300 POS BGA	84502-101	FCI/BERG
L1	FERRITE,SM,600 OHM,1500mA	BLM31P601SGPT	MURATA
R1,R2	RESISTOR, SM, 3.09K, 1%, 0603	CR0603-16W-3091FT	VENKEL
R6,R7	RES,SM,49.9,1%,0603	CR0603-16W-49R9FT	VENKEL
R14,R15,R16	POT,50K,10%,MULTITURN TRIMMER	T93YA-50K-10%-D06	VISHAY/DALE
U1	Si5100 Rev D Device	Si5100 Rev D	SILICON LABORATORIES
PCB	Printed Circuit Board	Si5100-EVB Daughter Card PCB Rev D	SILICON LABORATORIES
No Load			
SW1	SWITCH, PUSH BUTTON, MINIATURE	101-0161	MOUSER
R17	RES,SM,0.0603	CR0603-16W-000T	VENKEL

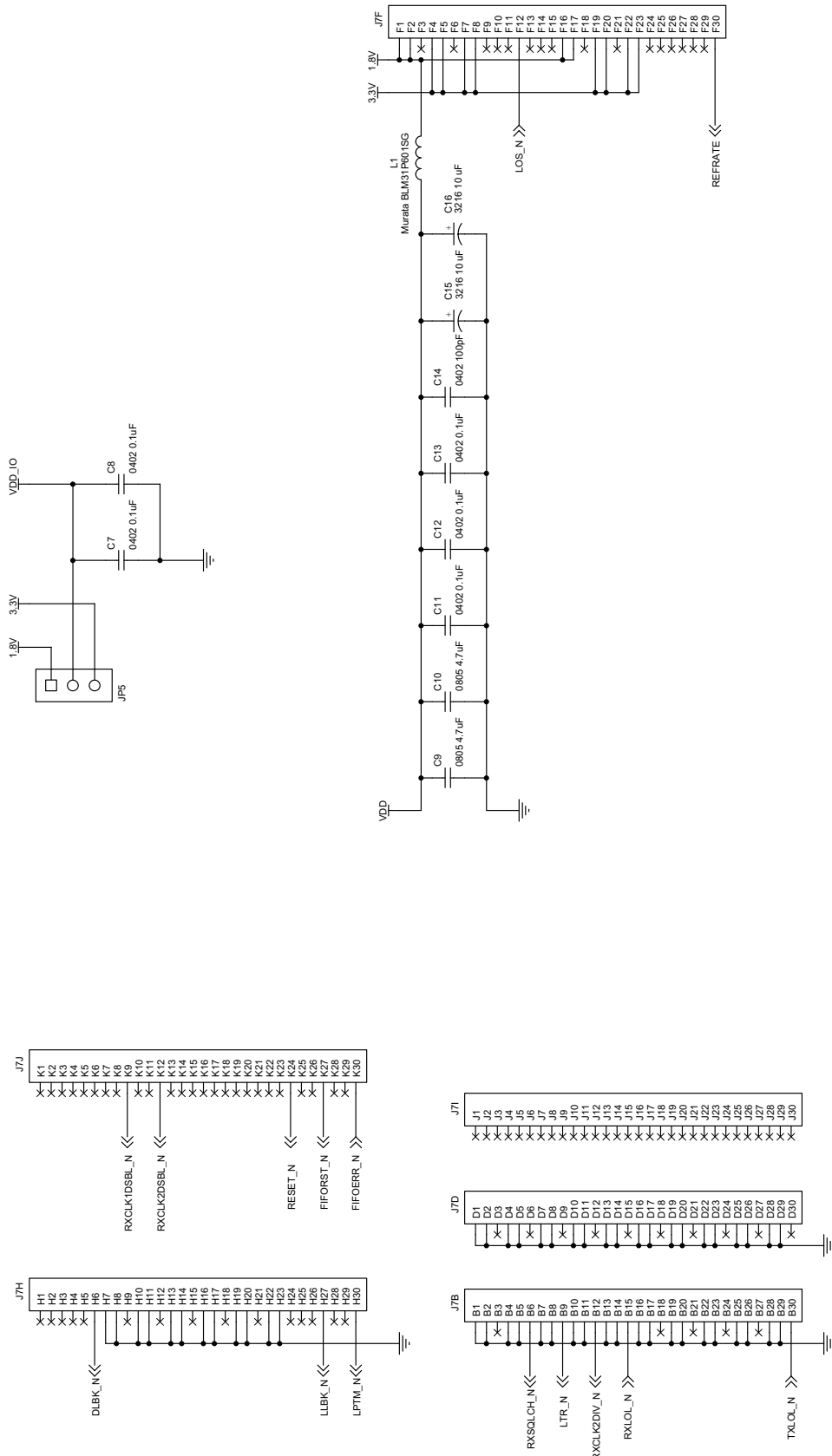

Figure 12. Si5110-EVB Daughter Card Schematic (page 2 of 3)

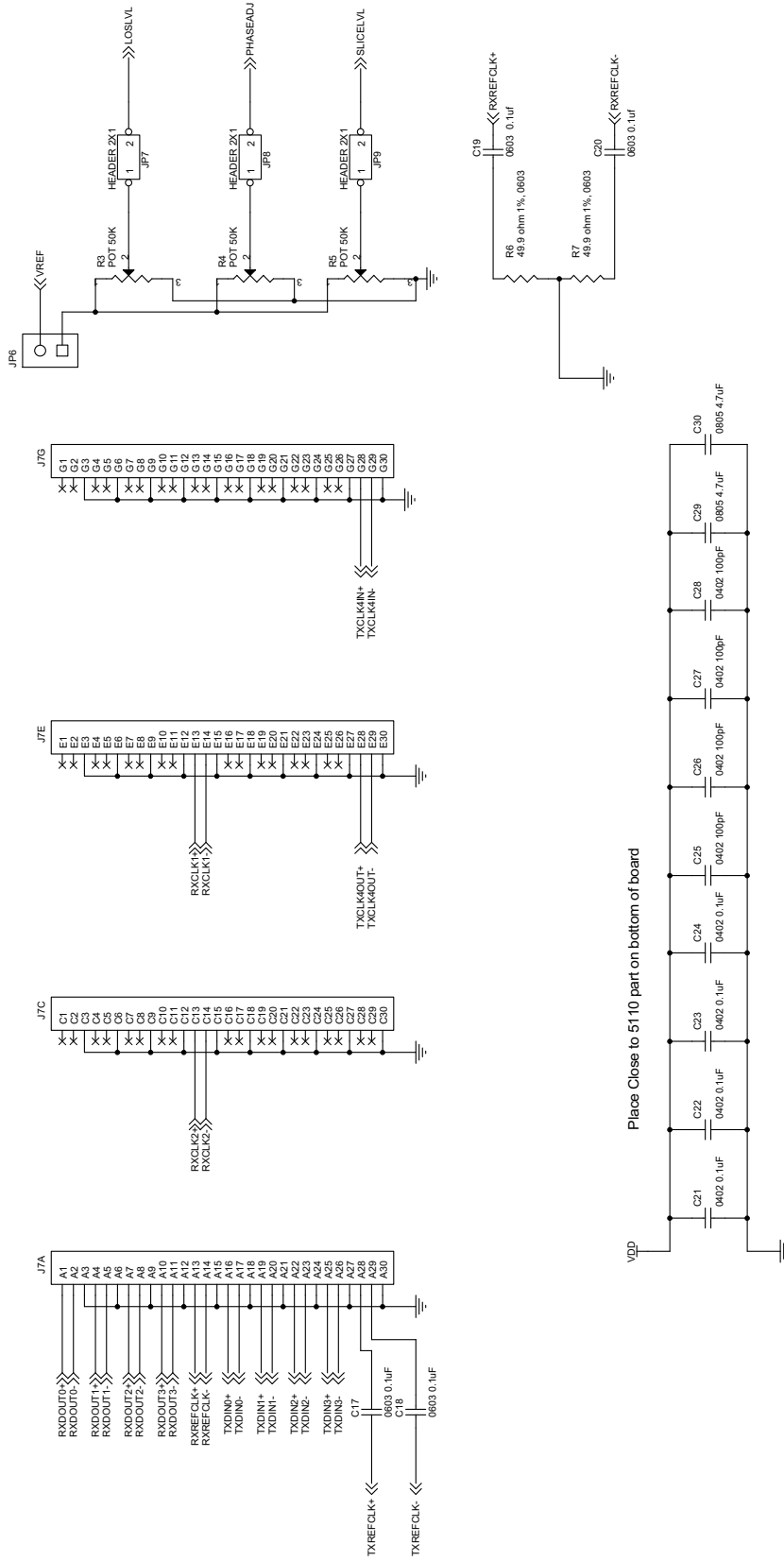

Figure 13. Si5110-EVB Daughter Card Schematic (page 3 of 3)

Si5100/Si5110-EVB

Bill of Materials: Si5110-EVB Daughter Card Assembly Revision D-01

Si5110 EVB Daughter Card Assy Rev. E-01 BOM			
Reference	Part Desc	Part Number	Manufacturer
C1,C2,C3,C4,C5,C6,C7,C8	CAP,SM,0.1UF,16V,10%,X7R,0402	C0402X7R160-104KNE	VENKEL
C11,C12,C13,C21,C22,C23			
C24			
C9,C10,C29,C30	CAP,SM,4.7UF,6.3V,X7R,0805	CEJMK212BJ475KG-T	TAIYO YUDEN
C14,C25,C26,C27,C28	CAP,SM,100PF,50V,5%,C0G,0402	C0402C0G500-101JNE	VENKEL
C15,C16	CAP,SM,10UF,10V,10%,TANTALUM,3216	TA010TCM106KAR	VENKEL
C17,C18,C19,C20	CAP,SM,0.1UF,16V,20%,X7R,0603	C0603X7R160-104KNE	VENKEL
JP1	CONN,HEADER,8X3	2380-6121TN or 2340-6111TN	3M
JP5	CONN,HEADER,3X1	2380-6121TN or 2340-6111TN	3M
JP4,JP6,JP7,JP8,JP9	CONN,HEADER,2X1	2380-6121TN or 2340-6111TN	3M
J1,J2,J3,J4,J5,J6	CONNECTOR, SMA, NOTCH MOUNT	82 SMA-S50-1-45/111 NE	HUBER SUHNER
J7	CONN,SM,RECPT,MEGARRAY,300 POS BGA	84502-101	FCI/BERG
L1	FERRITE,SM,600 OHM,1500mA	BLM31P601SGPT	MURATA
R2,R1	RES,SM,3.09K,1%,0603	CR0603-16W-3091FT	VENKEL
R3,R4,R5	POT,50K,10%,MULTITURN TRIMMER	T93YA-50K-10%-D06	VISHAY/DALE
R6,R7	RES,SM,49.9,1%,0603	CR0603-16W-49R9FT	VENKEL
U1	Si5110 Rev E Device	Si5110-BC	SILICON LABS
PCB	Printed Circuit Board	Si5110-EVB Daughter Card PCB Rev C	SILICON LABS
JP2	CONN,HEADER,4X3	2380-6121TN or 2340-6111TN	3M
JP3, JP10	CONN,HEADER,2X1	2380-6121TN or 2340-6111TN	3M
JP11	CONN,HEADER,1X3	2380-6121TN or 2340-6111TN	3M

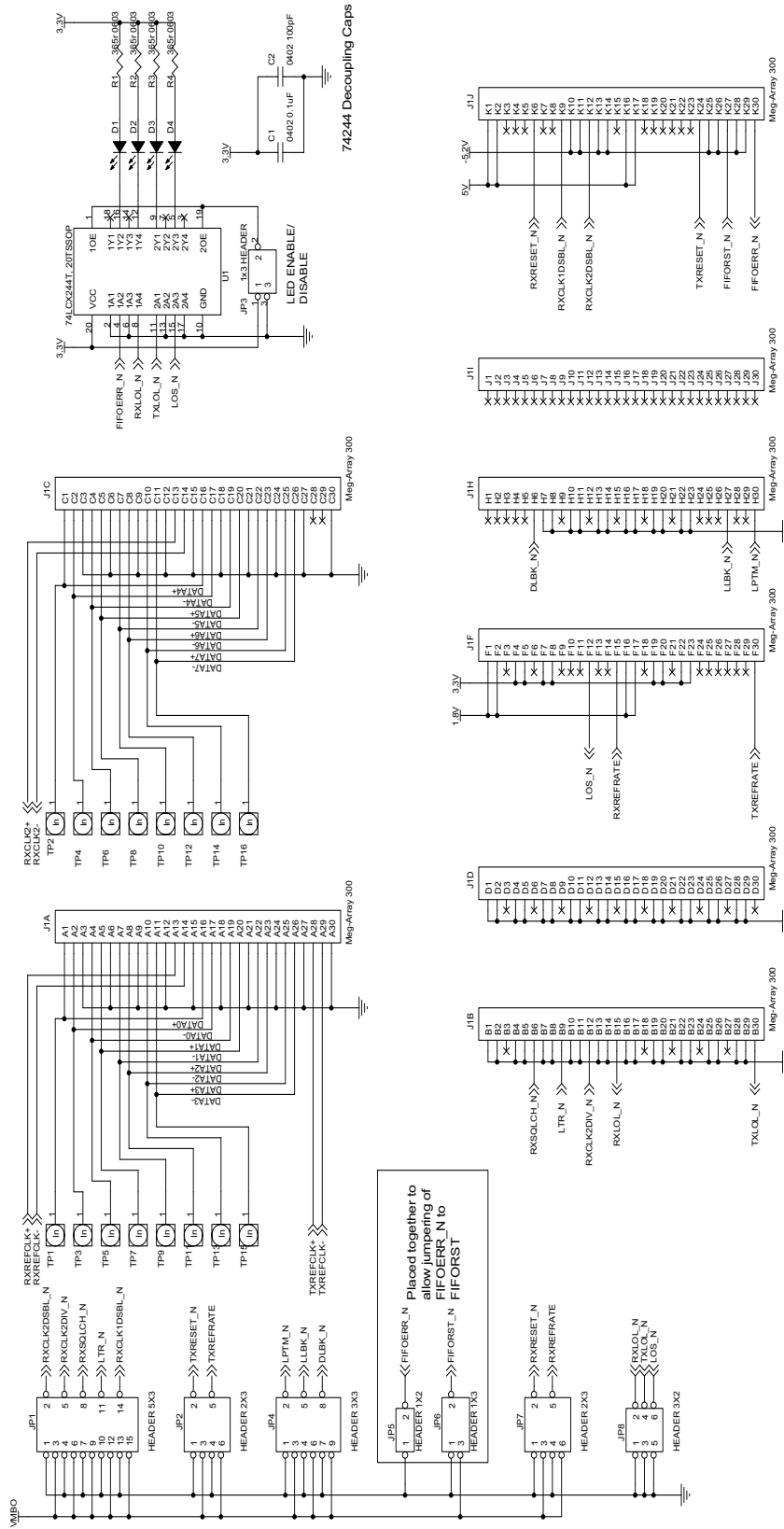

Figure 15. Loopback Motherboard Schematic (page 2 of 2)

Bill of Materials: Loopback Motherboard Assembly Revision A-01

Si5100 Loopback Motherboard Assy Rev A-01			
Reference	Part Desc	Part Number	Manufacturer
C1	CAP,SM,0.1UF,16V,10%,X7R,0402	C0402X7R160-104KNE	VENKEL
C2	CAP,SM,100PF,50V,5%,C0G,0402	C0402C0G500-101JNE	VENKEL
D1,D2,D3,D4	LED,SM,RED	LN1271RAL-TR	PANASONIC
JP1	CONN,HEADER,5X3	2380-6121TN or 2340-6111TN	3M
JP2,JP7	CONN,HEADER,2X3	2380-6121TN or 2340-6111TN	3M
JP3,JP6	CONN,HEADER,1X3	2380-6121TN or 2340-6111TN	3M
JP4	CONN,HEADER,3X3	2380-6121TN or 2340-6111TN	3M
JP5	CONN,HEADER,1X2	2380-6121TN or 2340-6111TN	3M
JP8	CONN,HEADER,3X2	2380-6121TN or 2340-6111TN	3M
JP10	CONN,HEADER,3X1	2380-6121TN or 2340-6111TN	3M
J1	CONNECTOR,SM,300 POS,BGA	84500-02	BERG
J2,J3,J4,J5,J6,J7,J8,J9, J10,J11,J12,J13	CONNECTOR,SMA,SURFACE MOUNT	142-0711-201	JOHNSON COMPONENTS
J15,J14	CONNECTOR,POWER,3 POSITION	1729021	PHOENIX CONTACT
R1,R2,R3,R4	RESISTOR, SM, 365 OHM, 1%, 0603	CR0603-16W-121JT	VENKEL
R5,R6,R7,R8,R9,R10,R11, R12,R13,R14,R15,R16	RES,SM,0,0402	CR0402-16W-000T	VENKEL
TP1,TP2,TP3,TP4,TP5,TP6, TP7,TP8,TP9,TP10,TP11, TP12,TP13,TP14,TP15,TP16, TP17,TP18,TP19,TP20,TP21, TP22,TP23,TP24,TP25,TP26, TP27,TP28,TP29,TP30,TP31, TP32	TEST POINTS ON PCB	N/A	N/A
U1	IC,SM,74LCX244,20TSSOP	74LCX244MTC	FAIRCHILD
PCB	Printed Circuit Board	Si5100-EVB Loopback Motherboard PCB Rev A	SILICON LABORATORIES

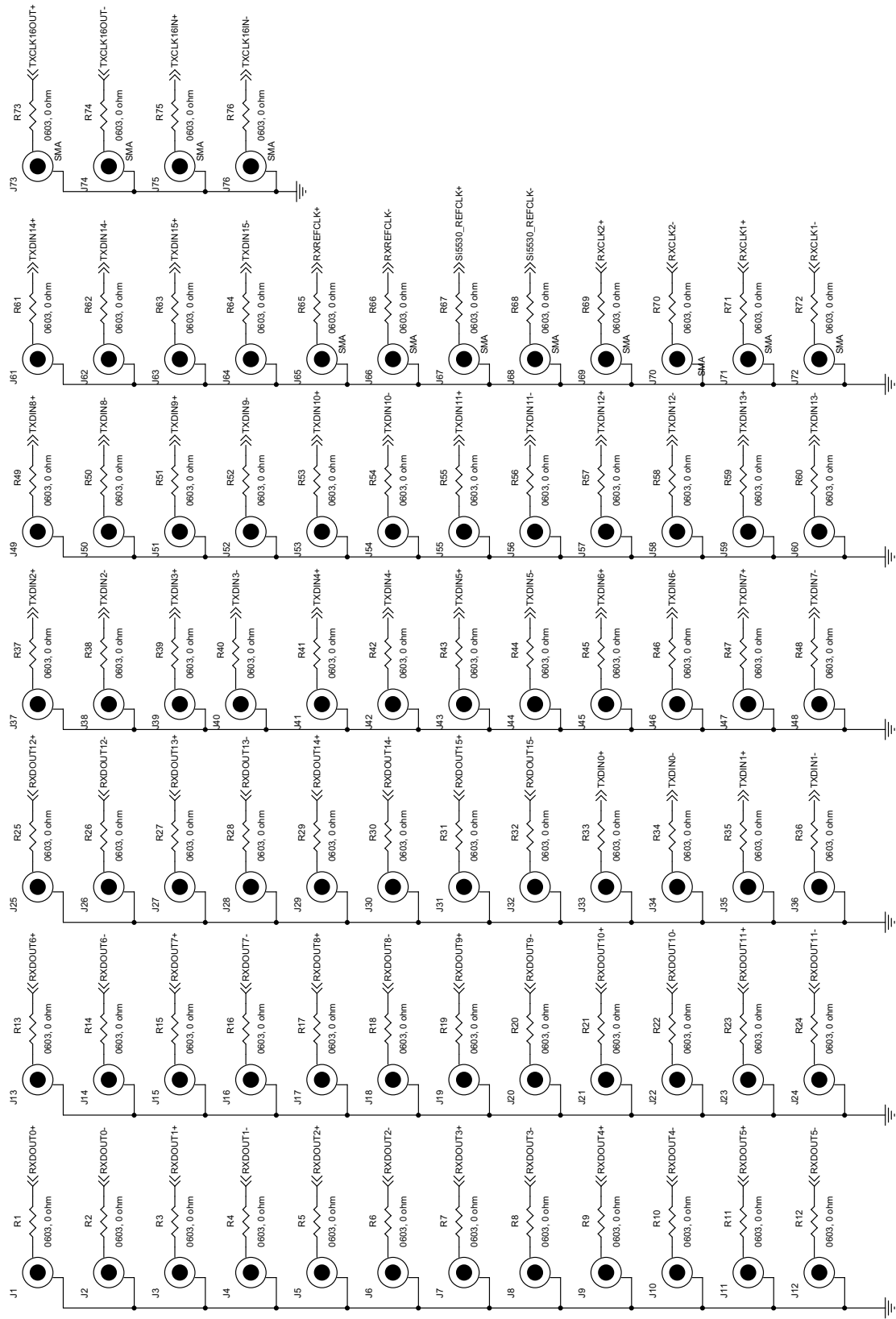

Figure 16. Full-Duplex Motherboard Schematic (page 1 of 2)

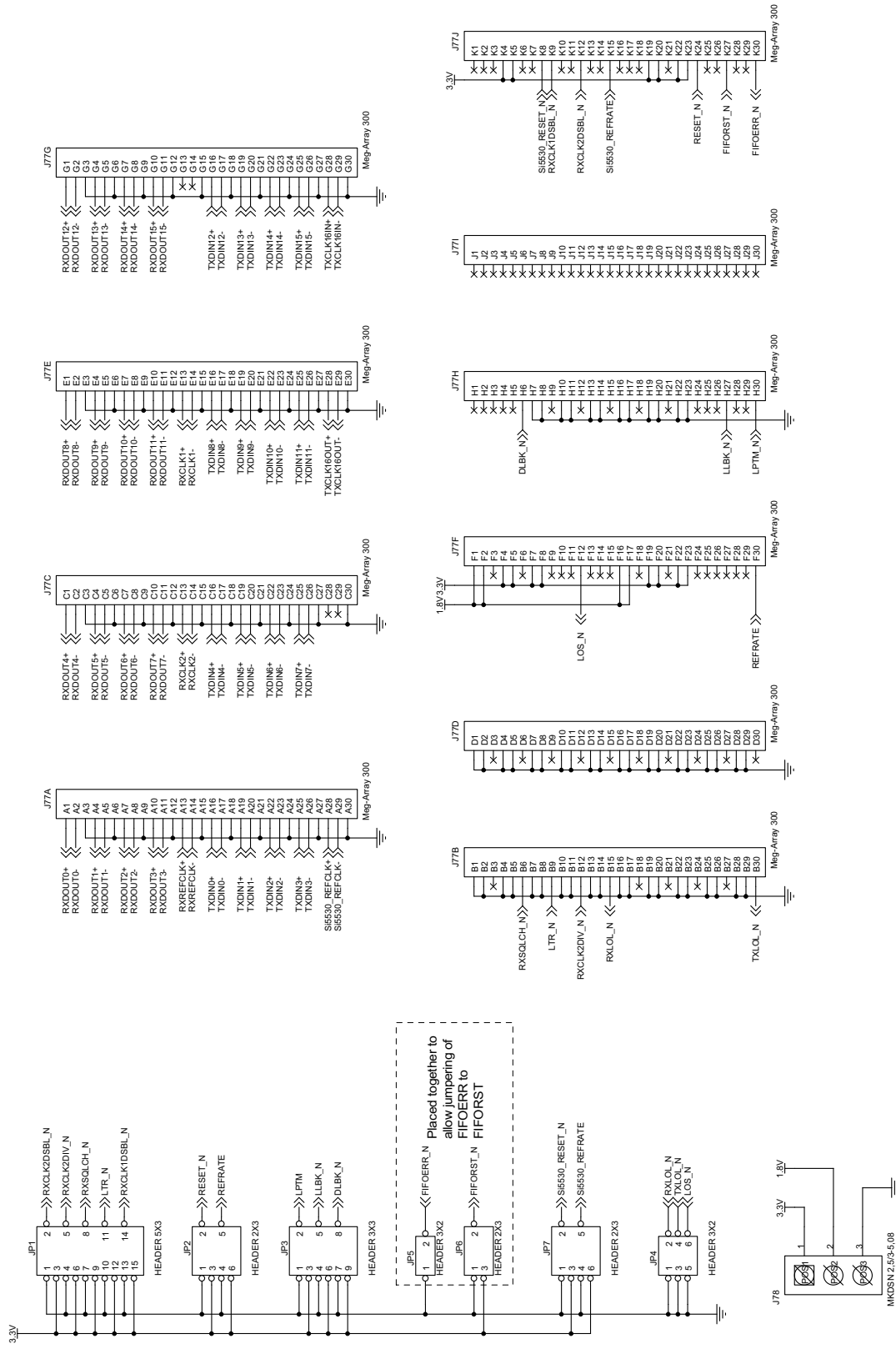

Figure 17. Full-Duplex Motherboard Schematic (page 2 of 2)

Si5100/Si5110-EVB

Bill of Materials: Full-Duplex Motherboard Assembly Revision C-01

Si5100 Motherboard Assy Rev C-01 BOM			
Reference	Part Desc	Part Number	Manufacturer
R1,R2,R3,R4,R5,R6,R7,R8, R9,R10,R11,R12,R13,R14, R15,R16,R17,R18,R19,R20, R21,R22,R23,R24,R25,R26, R27,R28,R29,R30,R31,R32, R33,R34,R35,R36,R37,R38, R39,R40,R41,R42,R43,R44, R45,R46,R47,R48,R49,R50, R51,R52,R53,R54,R55,R56, R57,R58,R59,R60,R61,R62, R63,R64,R65,R66,R67,R68, R69,R70,R71,R72,R73,R74, R75,R76	RES,SM,0,0402	CR0402-16W-000T	VENKEL
JP1	CONNECTOR,HEADER,5X3	2340-6111TN or 2380-6121TN	3M
JP2,JP4,JP7	CONNECTOR,HEADER,3X2	2340-6111TN or 2380-6121TN	3M
JP3	CONNECTOR,HEADER,3X3	2340-6111TN or 2380-6121TN	3M
JP5	CONNECTOR,HEADER,2X1	2340-6111TN or 2380-6121TN	3M
JP6	CONNECTOR,HEADER,3X1	2340-6111TN or 2380-6121TN	3M
J1,J2,J3,J4,J5,J6,J7,J8, J9,J10,J11,J12,J13,J14, J15,J16,J17,J18,J19,J20, J21,J22,J23,J24,J25,J26, J27,J28,J29,J30,J31,J32, J33,J34,J35,J36,J37,J38, J39,J40,J41,J42,J43,J44, J45,J46,J47,J48,J49,J50, J51,J52,J53,J54,J55,J56, J57,J58,J59,J60,J61,J62, J63,J64,J65,J66,J67,J68, J69,J70,J71,J72,J73,J74, J75,J76	CONNECTOR,SMA,SURFACE MOUNT	142-0711-201	JOHNSON COMPONENTS
J77	CONNECTOR,SM,300 POS,BGA	84500-02	BERG
J78	CONNECTOR,POWER,3 POSITION	1729021	PHOENIX CONTACT
PCB	Printed Circuit Board	Si5100-EVB Motherboard PCB Rev C	SILICON LABORATORIES

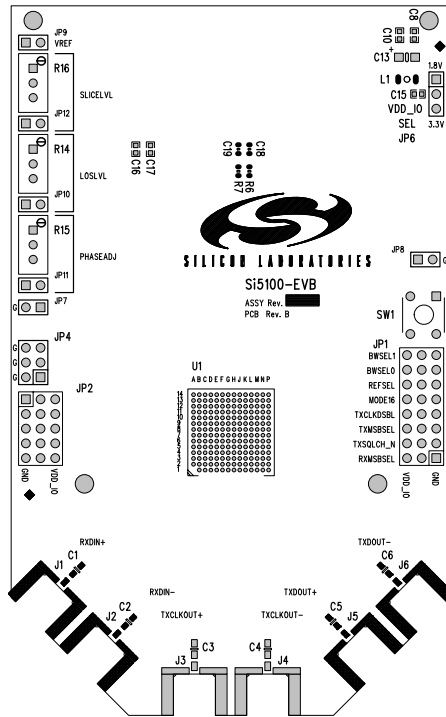

Figure 18. Si5100-EVB Component Side Assembly (Daughter Card)

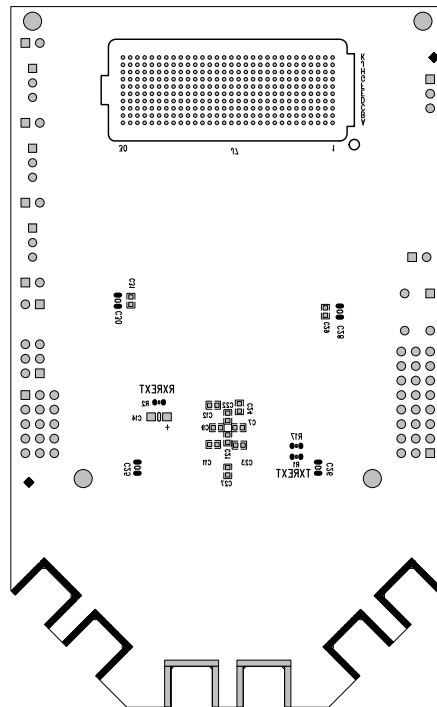

Figure 19. Si5100-EVB Solder Side Assembly (Daughter Card)

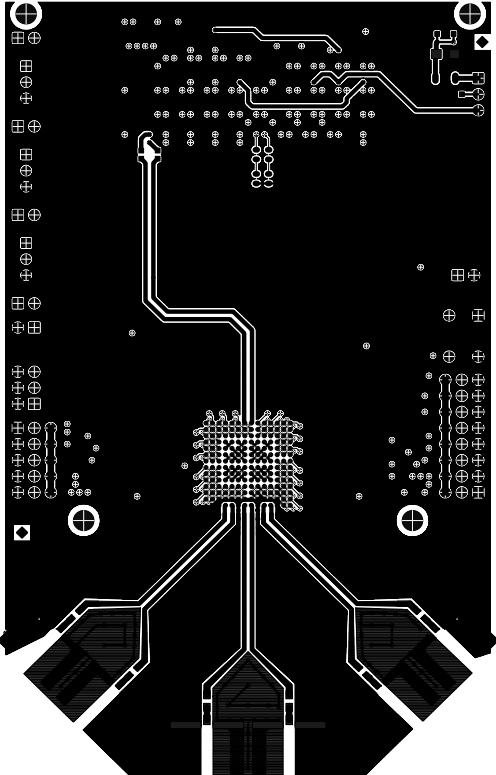

Figure 20. Si5100-EVB Layer 1—Component Side (Daughter Card)

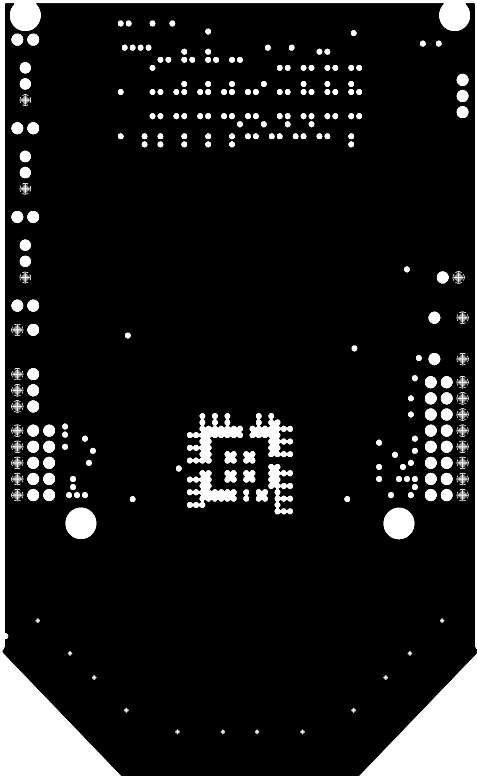

Figure 21. Si5100-EVB Layer 2—GND1 Plane (Daughter Card)

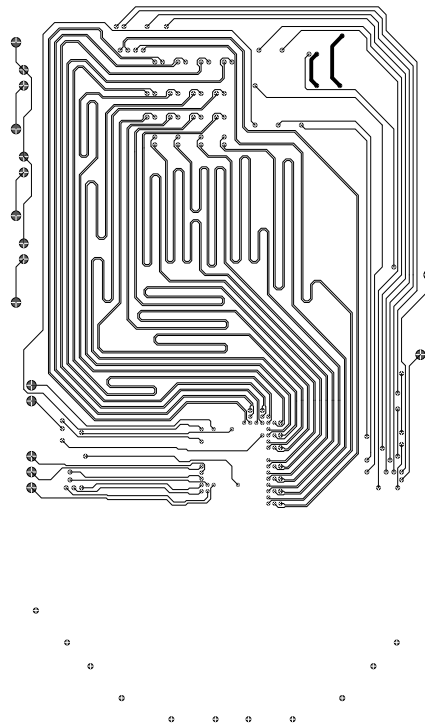

Figure 22. Si5100-EVB Layer 3—Signal Plane (Daughter Card)

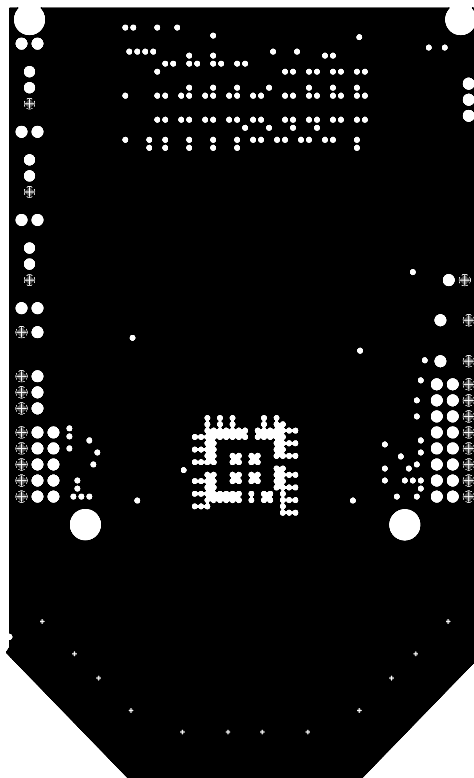

Figure 23. Si5100-EVB Layer 4—GND2 Plane (Daughter Card)

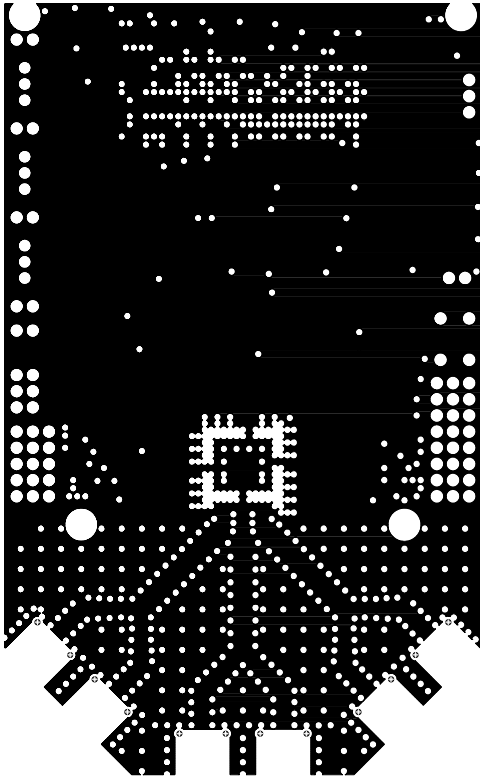

Figure 24. Si5100-EVB Layer 5—VDD Plane (Daughter Card)

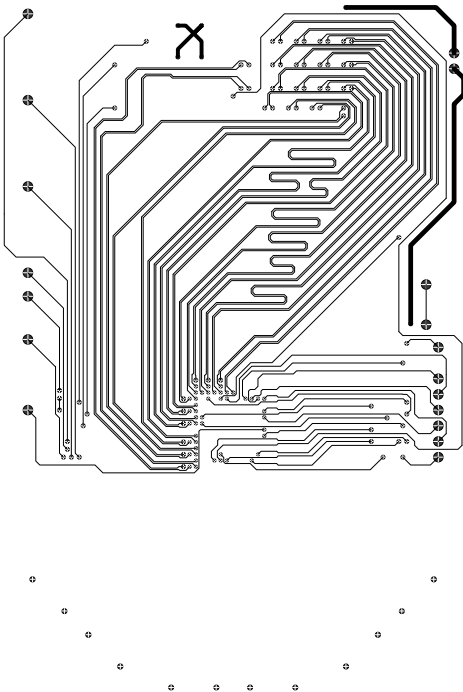

Figure 25. Si5100-EVB Layer 6—Signal Plane (Daughter Card)

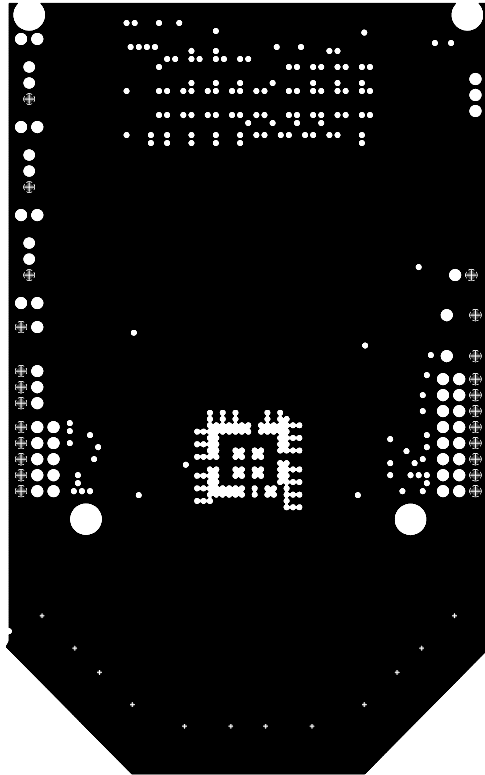

Figure 26. Si5100-EVB Layer 7—GND3 Plane (Daughter Card)

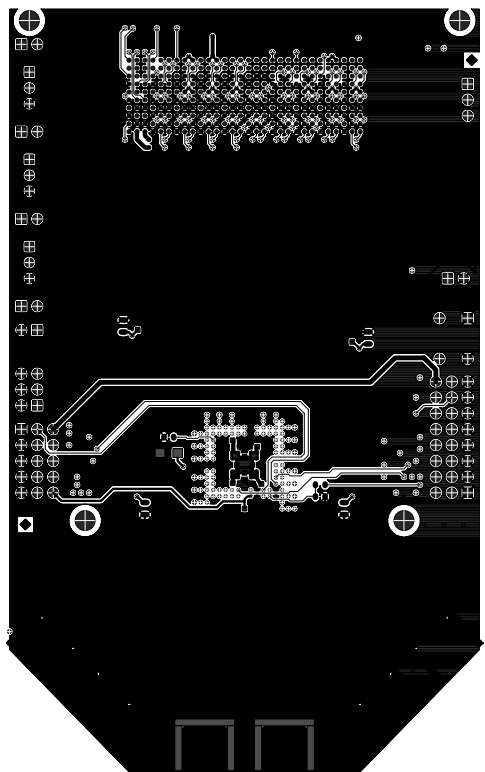

Figure 27. Si5100-EVB Layer 8—Solder Side (Daughter Card)

Si5100/Si5110-EVB

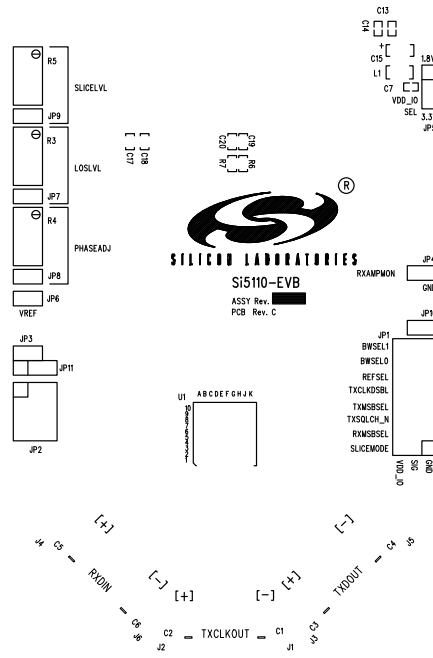

Figure 28. Si5110-EVB Component Side Assembly (Daughter Card)

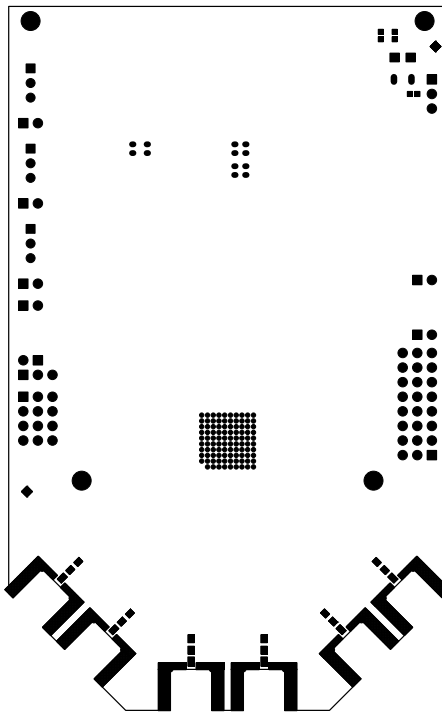

Figure 29. Si5110-EVB Solder Side Assembly (Daughter Card)

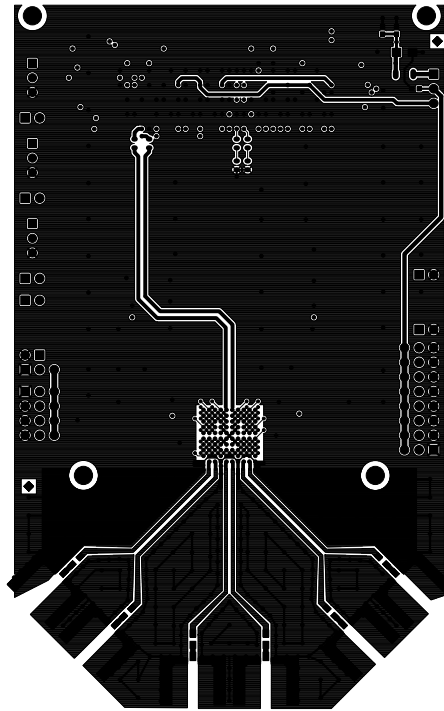

Figure 30. Si5110-EVB Layer 1—Component Side (Daughter Card)

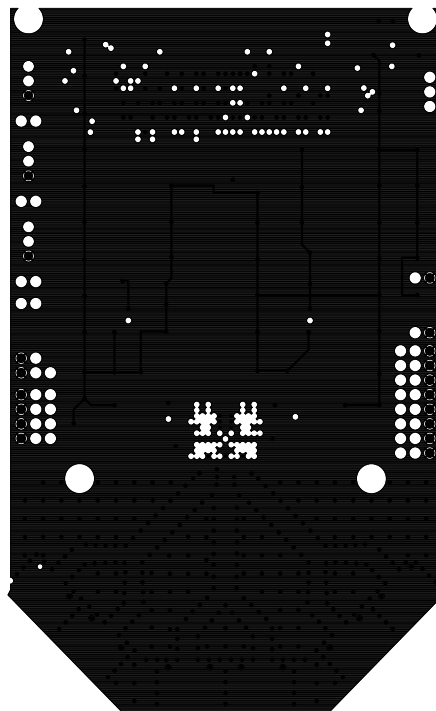

Figure 31. Si5110-EVB Layer 2—GND1 Plane (Daughter Card)

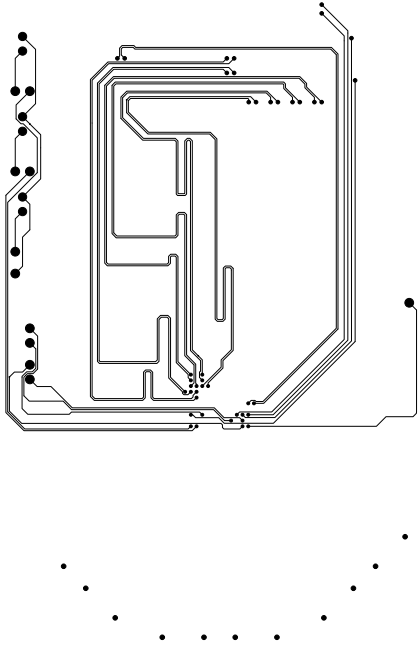

Figure 32. Si5110-EVB Layer 3—Signal Plane (Daughter Card)

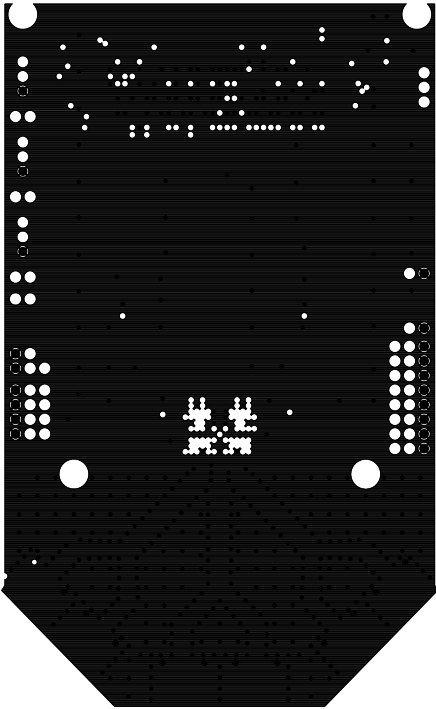

Figure 33. Si5110-EVB Layer 4—GND2 Plane (Daughter Card)

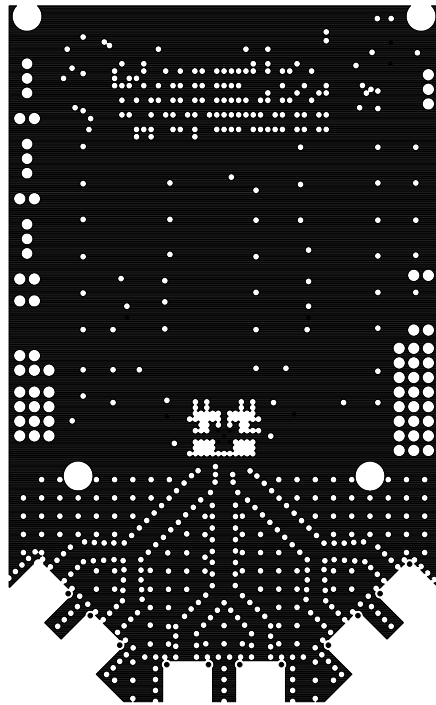

Figure 34. Si5110-EVB Layer 5—VDD Plane (Daughter Card)

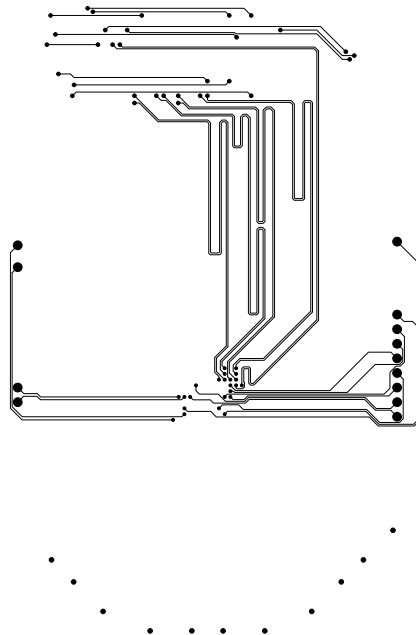

Figure 35. Si5110-EVB Layer 6—Signal Plane (Daughter Card)

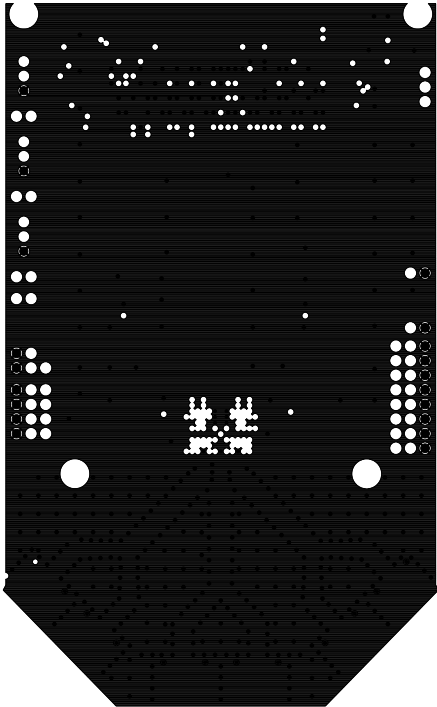

Figure 36. Si5110-EVB Layer 7—GND3 Plane (Daughter Card)

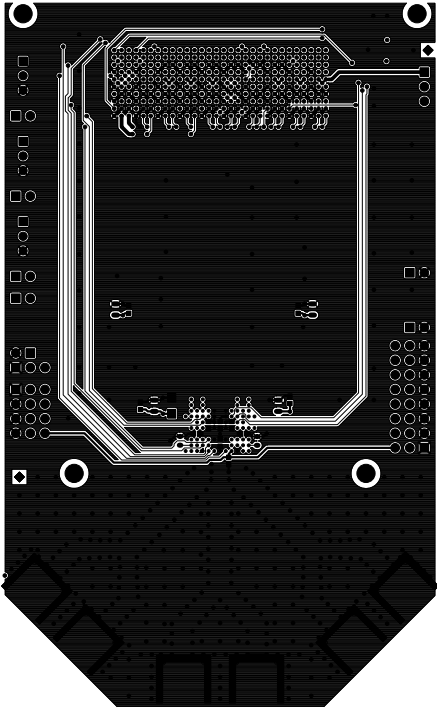

Figure 37. Si5110-EVB Layer 8—Solder Side (Daughter Card)

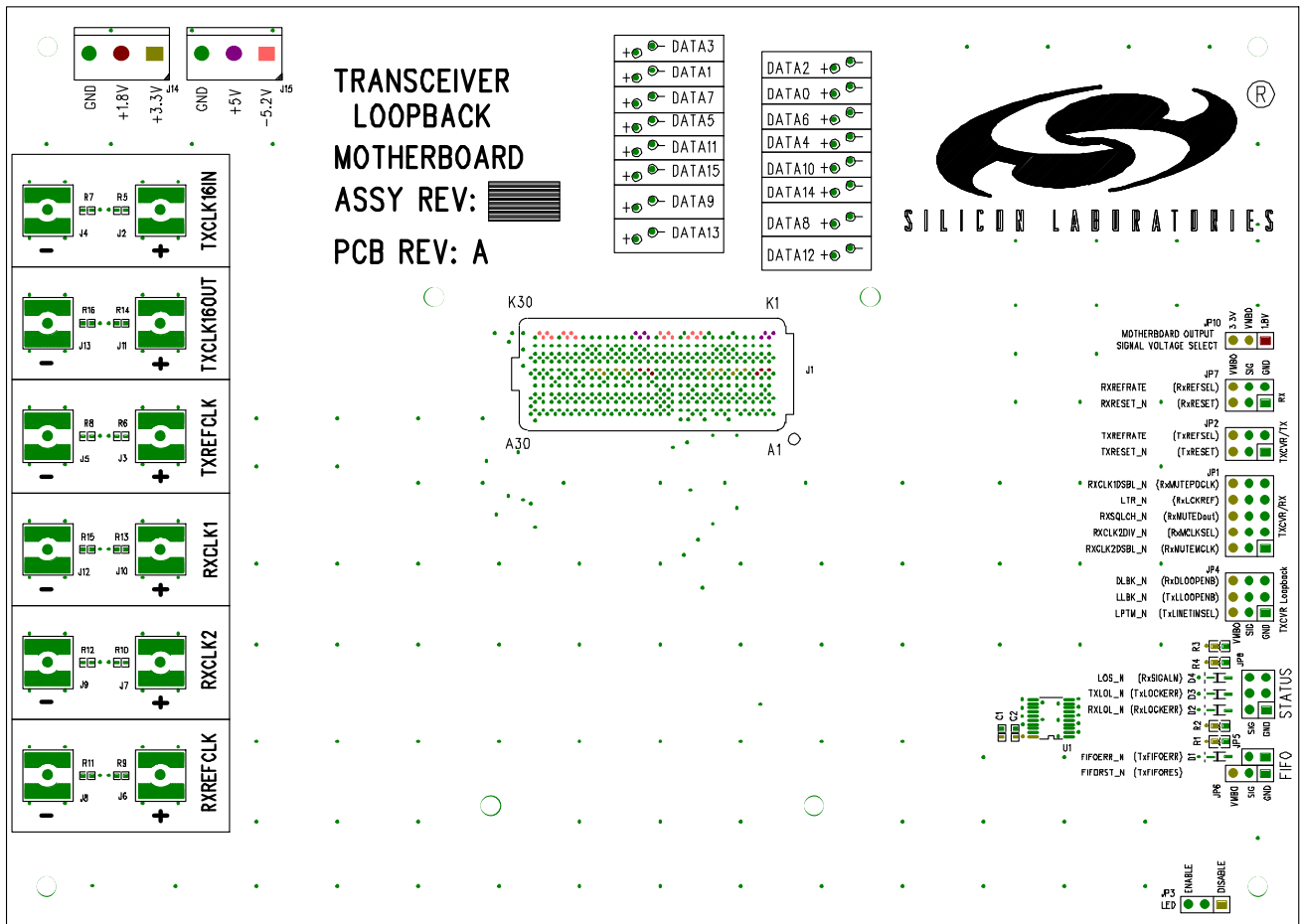

Figure 38. Component Side Assembly (Loopback Motherboard)

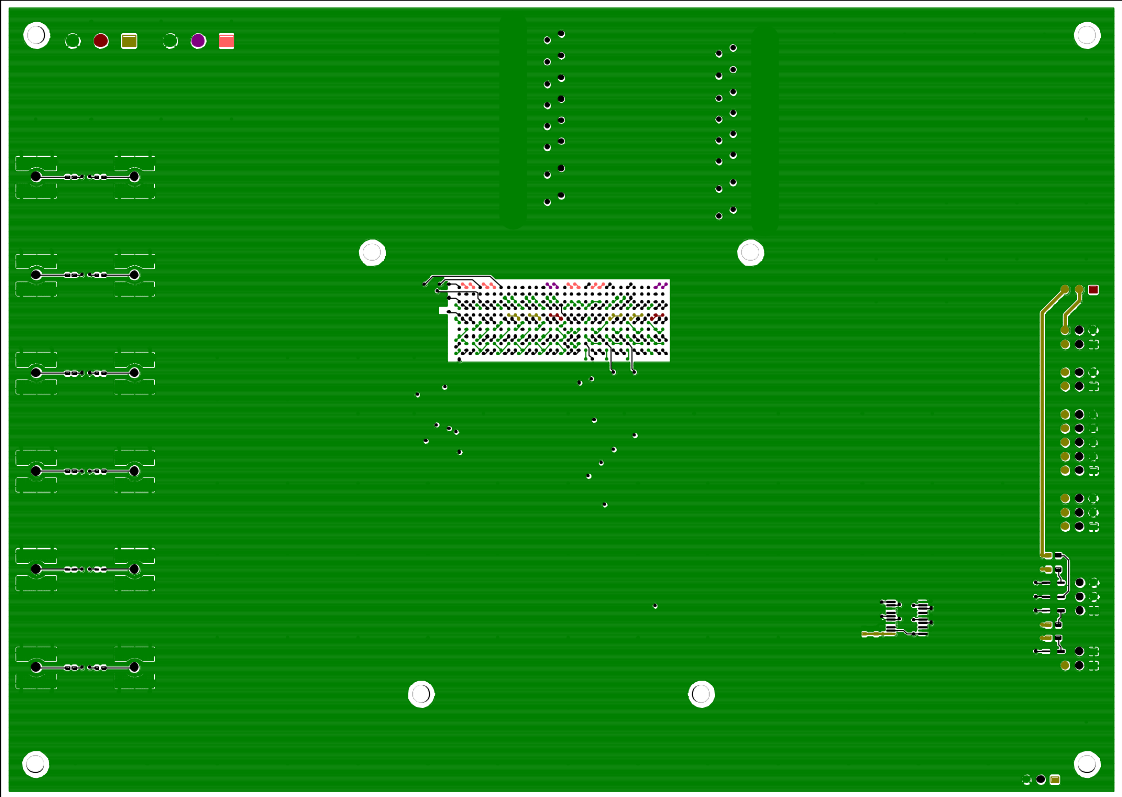

Figure 39. Layer 1—Component Side (Loopback Motherboard)

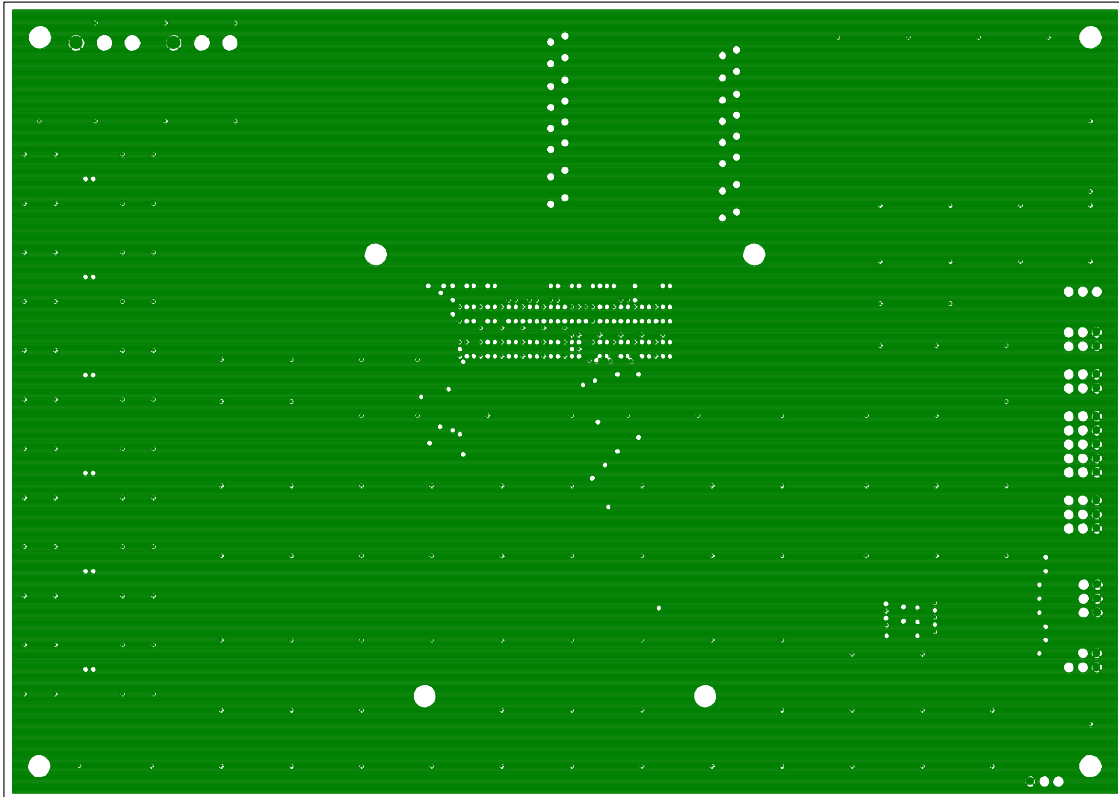

Figure 40. Layer 2—GND1 Plane (Loopback Motherboard)

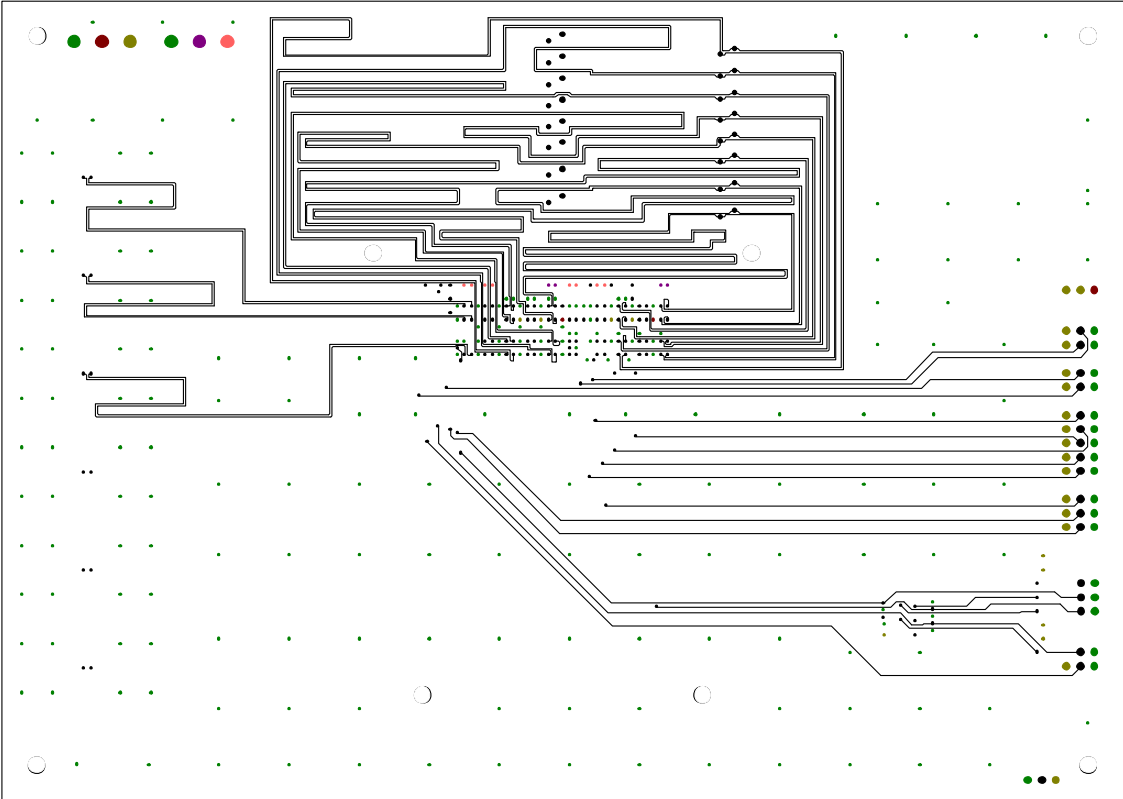

Figure 41. Layer 3—Signal 1 Plane (Loopback Motherboard)

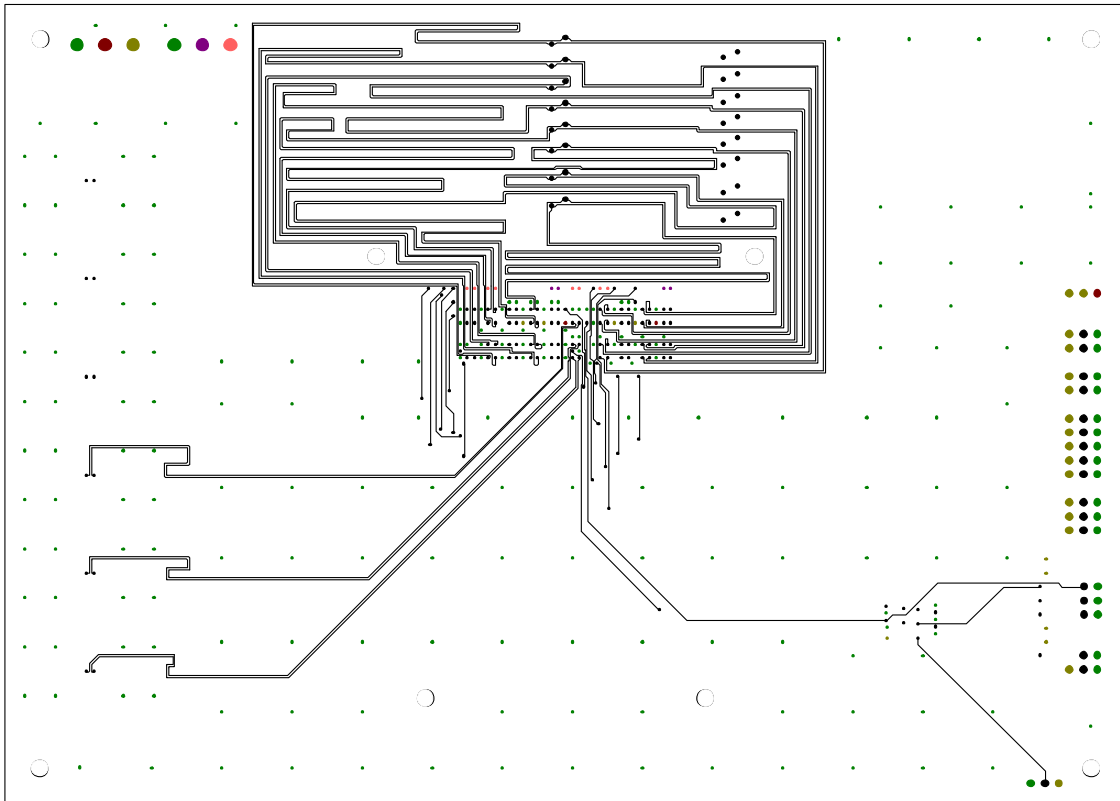

Figure 42. Layer 4—Signal 2 Plane (Loopback Motherboard)

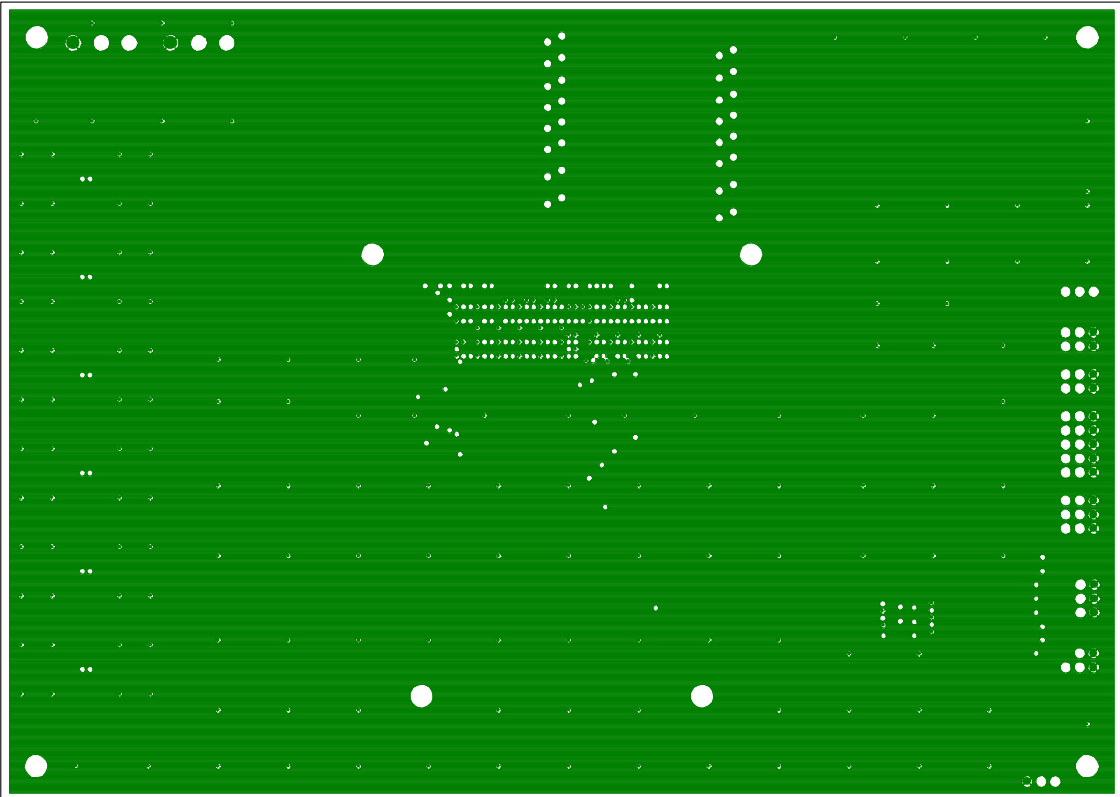

Figure 43. Layer 5—GND2 Plane (Loopback Motherboard)

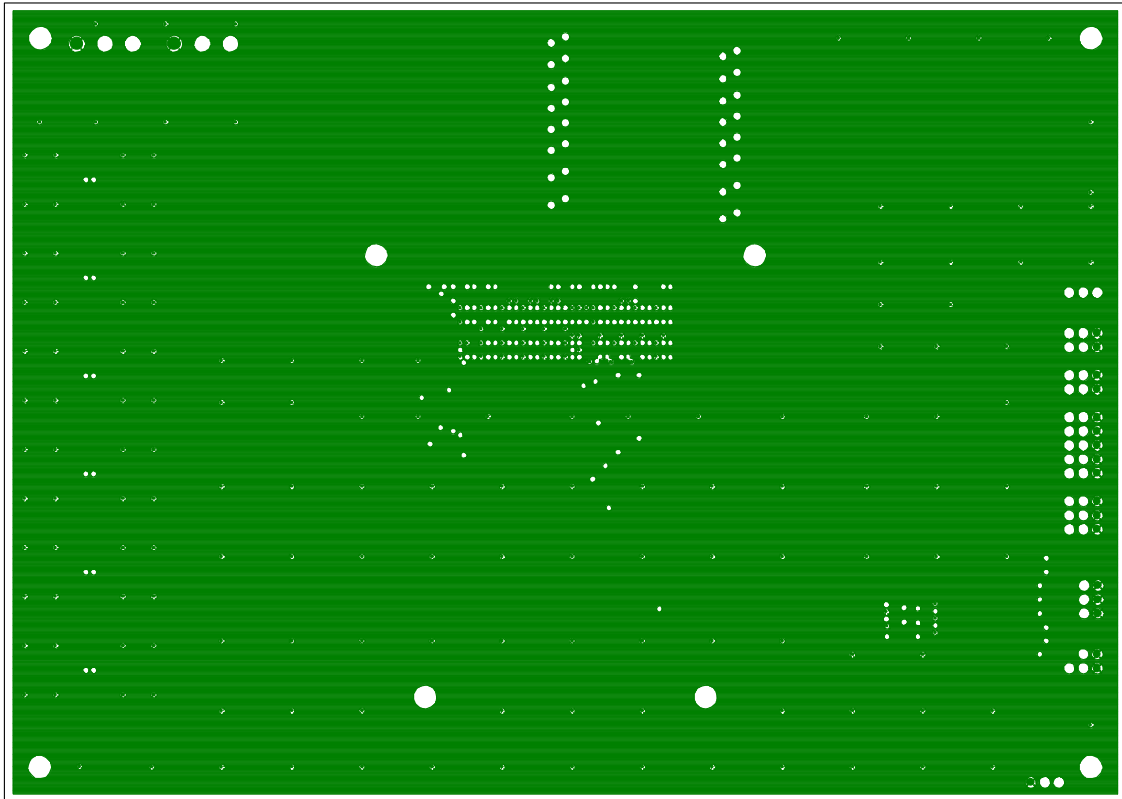

Figure 44. Layer 6—Solder Side (Loopback Motherboard)

Si5100/Si5110-EVB

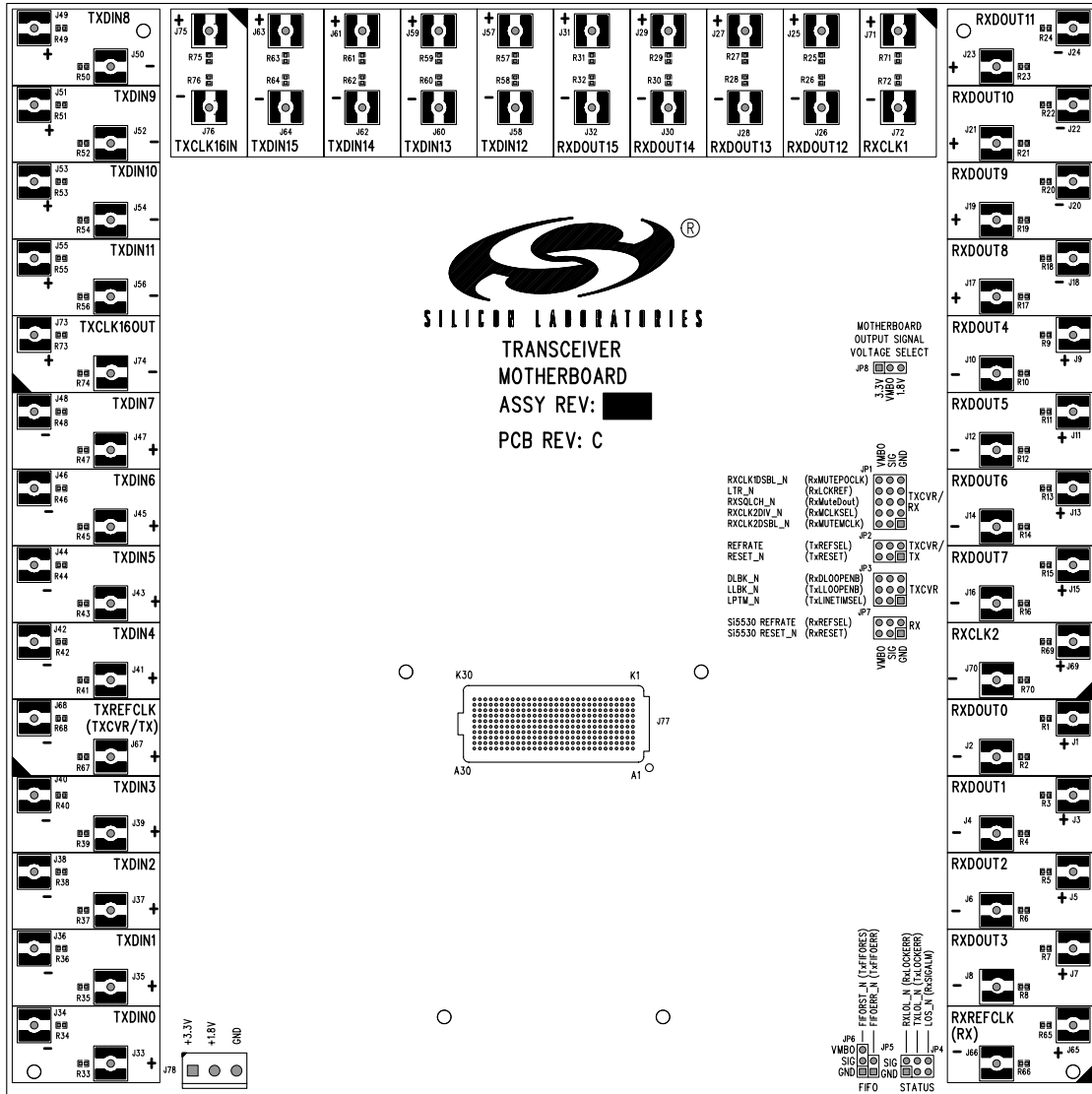

Figure 45. Component Side Assembly (Optional Full-Duplex Motherboard)

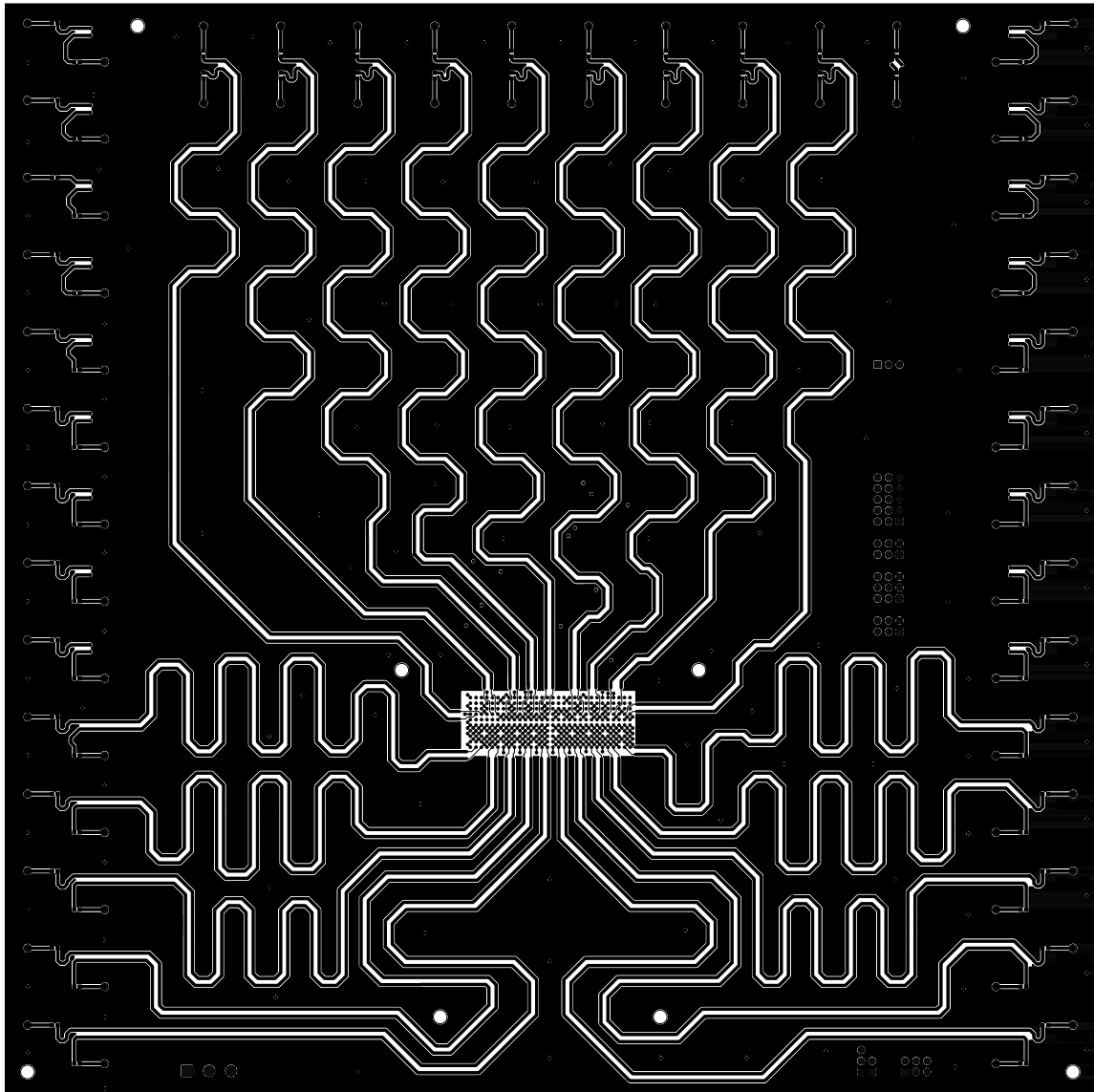

Figure 46. Layer 1—Component Side (Optional Full-Duplex Motherboard)



Figure 47. Layer 2—GND1 Plane (Optional Full-Duplex Motherboard)

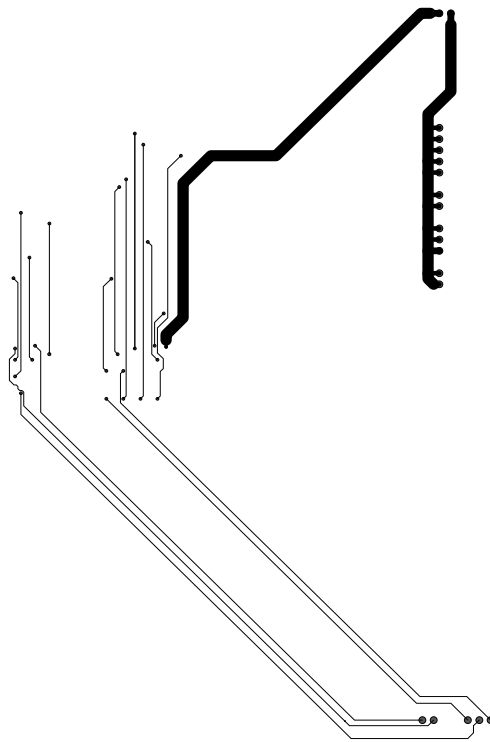

Figure 48. Layer 3—Signal 1 Plane (Optional Full-Duplex Motherboard)

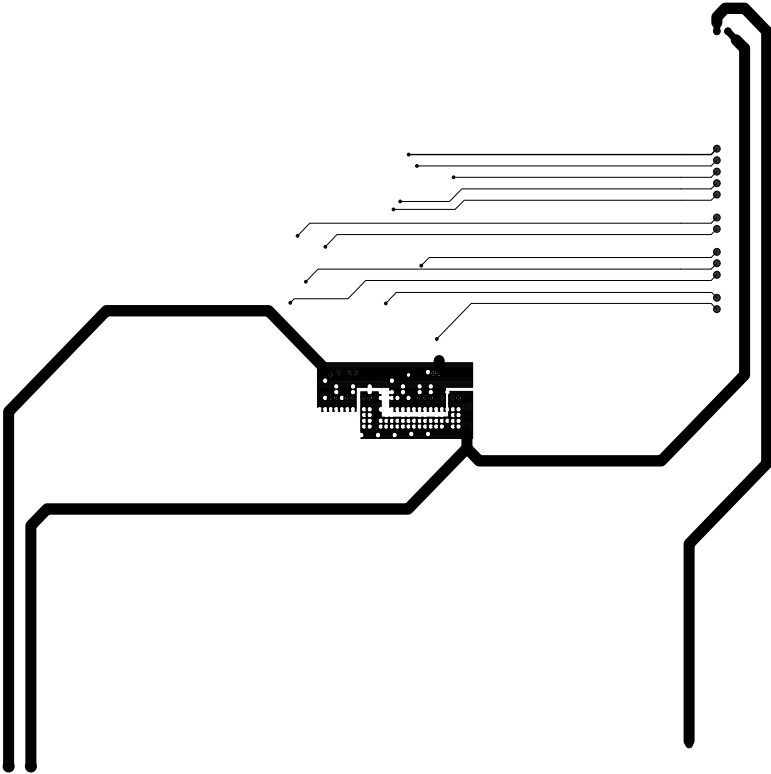

Figure 49. Layer 4—Signal 2 Plane (Optional Full-Duplex Motherboard)



Figure 50. Layer 5—GND2 Plane (Optional Full-Duplex Motherboard)

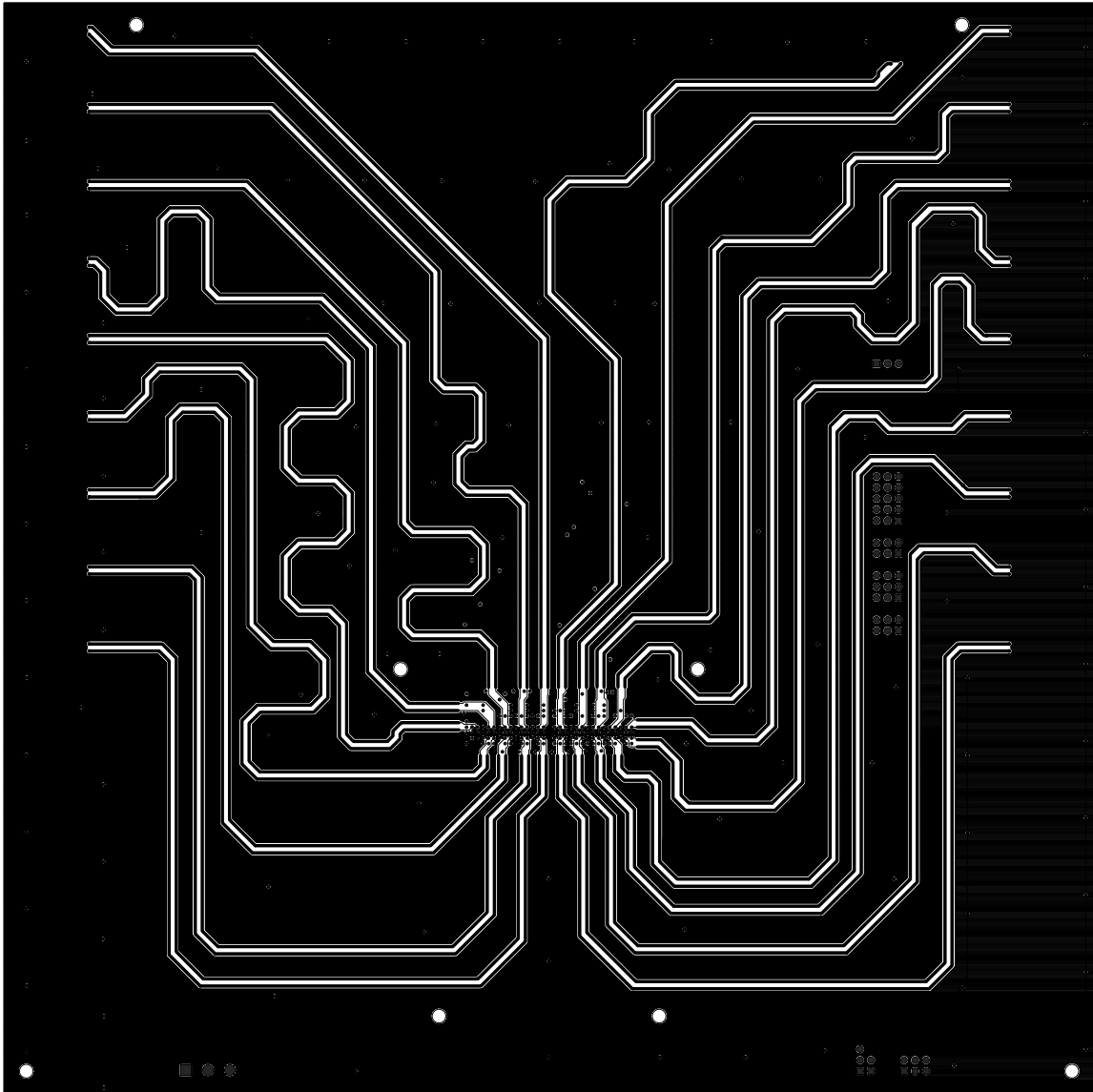

Figure 51. Layer 6—Solder Side (Optional Full-Duplex Motherboard)

Document Change List

Revision 0.4 to Revision 0.5

- Split Table 3 into Tables 3 and 4 to reflect differences in the actual PCBs for the Si5100 and Si5110 devices.
- Updated table references to reflect the changes in Table 3 and the creation of Table 4.

Evaluation Board Assembly Revision History

Si5100-EVB Daughter Card Revision History

Assembly Level	PCB	Si5600 Device	Assembly Notes
C-01	Rev. B	Rev. C	Assemble per BOM rev C-01
D-01	Rev. B	Rev. D	Assemble per BOM rev D-01

Full-Duplex Motherboard Revision History

Assembly Level	PCB	Assembly Notes
A-01	Rev. A	Assemble per BOM rev A-01
B-01	Rev. B	Assemble per BOM rev B-01
C-01	Rev. C	Assemble per BOM rev C-01

Loopback Motherboard Revision History

Assembly Level	PCB	Assembly Notes
A-01	Rev. A	Assemble per BOM rev A-01



ClockBuilder Pro

One-click access to Timing tools, documentation, software, source code libraries & more. Available for Windows and iOS (CBGo only).

www.silabs.com/CBPro



Timing Portfolio
www.silabs.com/timing



SW/HW
www.silabs.com/CBPro



Quality
www.silabs.com/quality



Support and Community
community.silabs.com

Disclaimer

Silicon Laboratories intends to provide customers with the latest, accurate, and in-depth documentation of all peripherals and modules available for system and software implementers using or intending to use the Silicon Laboratories products. Characterization data, available modules and peripherals, memory sizes and memory addresses refer to each specific device, and "Typical" parameters provided can and do vary in different applications. Application examples described herein are for illustrative purposes only. Silicon Laboratories reserves the right to make changes without further notice and limitation to product information, specifications, and descriptions herein, and does not give warranties as to the accuracy or completeness of the included information. Silicon Laboratories shall have no liability for the consequences of use of the information supplied herein. This document does not imply or express copyright licenses granted hereunder to design or fabricate any integrated circuits. The products must not be used within any Life Support System without the specific written consent of Silicon Laboratories. A "Life Support System" is any product or system intended to support or sustain life and/or health, which, if it fails, can be reasonably expected to result in significant personal injury or death. Silicon Laboratories products are generally not intended for military applications. Silicon Laboratories products shall under no circumstances be used in weapons of mass destruction including (but not limited to) nuclear, biological or chemical weapons, or missiles capable of delivering such weapons.

Trademark Information

Silicon Laboratories Inc., Silicon Laboratories, Silicon Labs, SiLabs and the Silicon Labs logo, CMEMS®, EFM, EFM32, EFR, Energy Micro, Energy Micro logo and combinations thereof, "the world's most energy friendly microcontrollers", Ember®, EZLink®, EZMac®, EZRadio®, EZRadioPRO®, DSPLL®, ISOmodem®, Precision32®, ProSLIC®, SiPHY®, USBXpress® and others are trademarks or registered trademarks of Silicon Laboratories Inc. ARM, CORTEX, Cortex-M3 and THUMB are trademarks or registered trademarks of ARM Holdings. Keil is a registered trademark of ARM Limited. All other products or brand names mentioned herein are trademarks of their respective holders.



SILICON LABS

Silicon Laboratories Inc.
400 West Cesar Chavez
Austin, TX 78701
USA

<http://www.silabs.com>