

DETAILS

Product Number	CA12514_RITA-A
Family	Rita
Type	RefAssy
Color	white
Diameter	36 + 28,4 mm
Height	17,3 mm
Style	rectang
Optic Material	
Holder Material	
Fastening	pin, tape
Status	production ready
ROHS Compliant	Yes
Date Updated	5/11/2014



OPTICAL PROPERTIES

LED	Viewing Angle	Light Beam	Efficiency	cd/lm	Connector
XP-G	Asymmetric deg	Asymmetric	86 %	-	-
XT-E	Asymmetric deg	Asymmetric	86 %	-	-
XB-D	Asymmetric deg	Asymmetric	84 %	-	-
XM-L	Asymmetric deg	Asymmetric	85 %	0.600	-
XM-L2	asymmetric deg	Asymmetric	86 %	0.600	-
XP-G2	asymmetric deg	Asymmetric	87 %	0.550	-
LUXEON A	Asymmetric deg	Asymmetric	87 %	0.600	-
LUXEON Rebel ES	Asymmetric deg	Asymmetric	85 %	-	-
LUXEON Rebel	Asymmetric deg	Asymmetric	87 %	0.600	-
LUXEON T	Asymmetric deg	Asymmetric	87 %	0.600	-
LUXEON TX	Asymmetric deg	Asymmetric	87 %	0.610	-
NVSxx19A	Asymmetric deg	Asymmetric	86 %	0.600	-
NCSxx19A	Asymmetric deg	Asymmetric	86 %	0.600	-
NS9x383	Asymmetric deg	Asymmetric	87 %	0.600	-
NVSxx19B/NVSxx19C	Asymmetric deg	Asymmetric	86 %	0.610	-
Oslon SSL 80	Asymmetric deg	Asymmetric	87 %	0.600	-
Oslon SSL 150	Asymmetric deg	Asymmetric	86 %	0.600	-

D

C

B

A

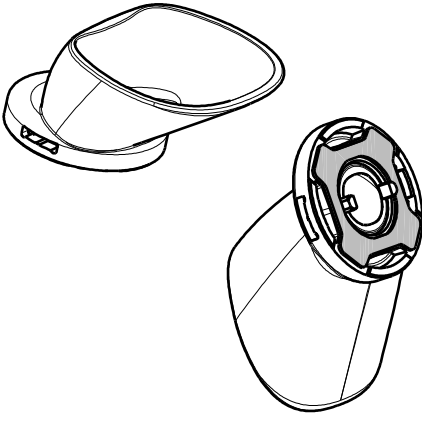

Isometric view

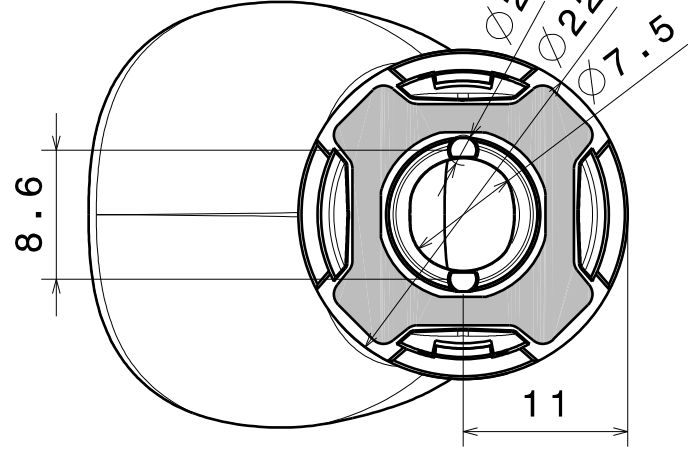

Bottom view

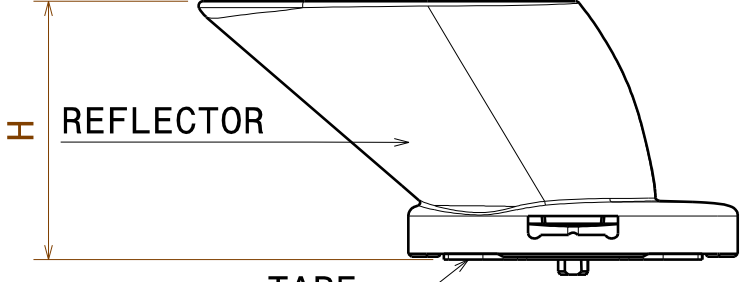

Front view

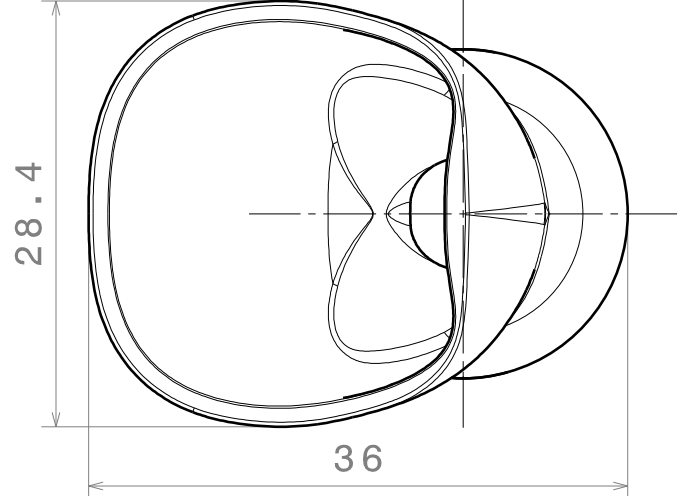

Top view

DIMENSION H:
 - WITH TAPE 17.3mm
 - WITHOUT TAPE 17.1mm

Tolerances for dimensions:
 0-20mm tolerance value +/-0.1mm
 21-45mm tolerance value +/-0.2mm
 46-90mm tolerance value +/-0.3mm
 91-100mm tolerance value +/-0.4mm
 101-mm tolerance value +/-0.5mm

This drawing is our property.
 It can't be reproduced
 or communicated without
 our written agreement.



Ledil Oy
 Salorankatu 10
 FIN 24240 SALO
 Finland

DRAWING TITLE
Datasheet RITA-A reflector

DRAWN BY
 mav

DATE
 30.12.2011

CHECKED BY
 sn

DATE
 30.12.2011

SIZE **A4** DRAWING NUMBER - REV **1**

DESIGNED BY
 hh/pl

DATE
 30.12.2011

SCALE 1:1 WEIGHT (g) SHEET 1/1

D

A

Luminaire: Ledil Oy C12512_RITA-A / CA12514_RITA-A (XM-L) Efficiency=85%
Lamps: 1 x Cree XM-L 87lm@250mA

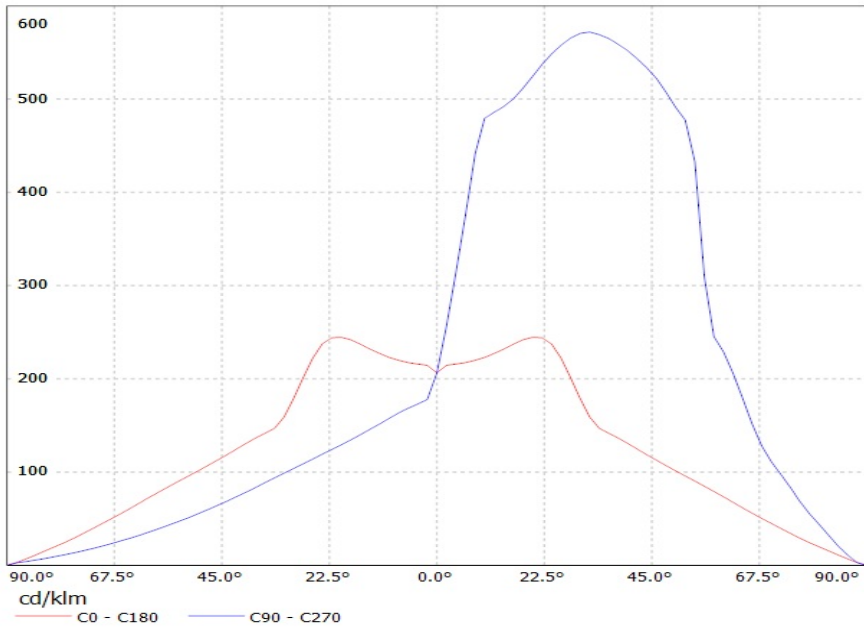

Luminaire: LEDil Oy CA12514_RITA-A_(XM-L2) Efficiency=86%
Lamps: 1 x Cree XM-L2 (XMLBWT-0-7B4-T30-0L-0001) 91lm @ 250mA CCT=3200K P=0.7W I=250mA

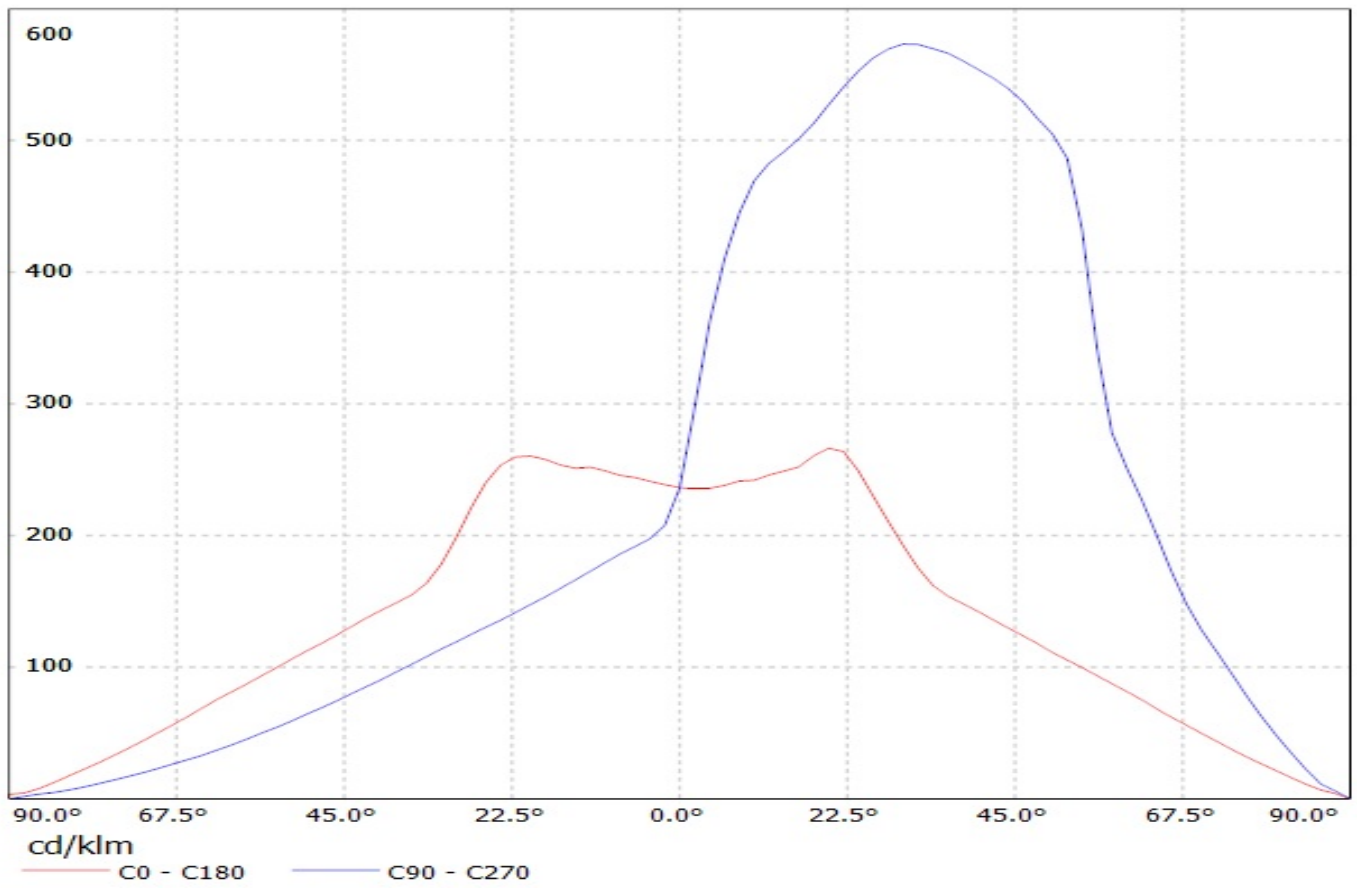

Luminaire: LEDil Oy RITA-A
Lamps: 1 x CREE xp-g2 101lm@250mA (XPGBWT-L1-0000-00FE4) CCT:5000K I:250mA

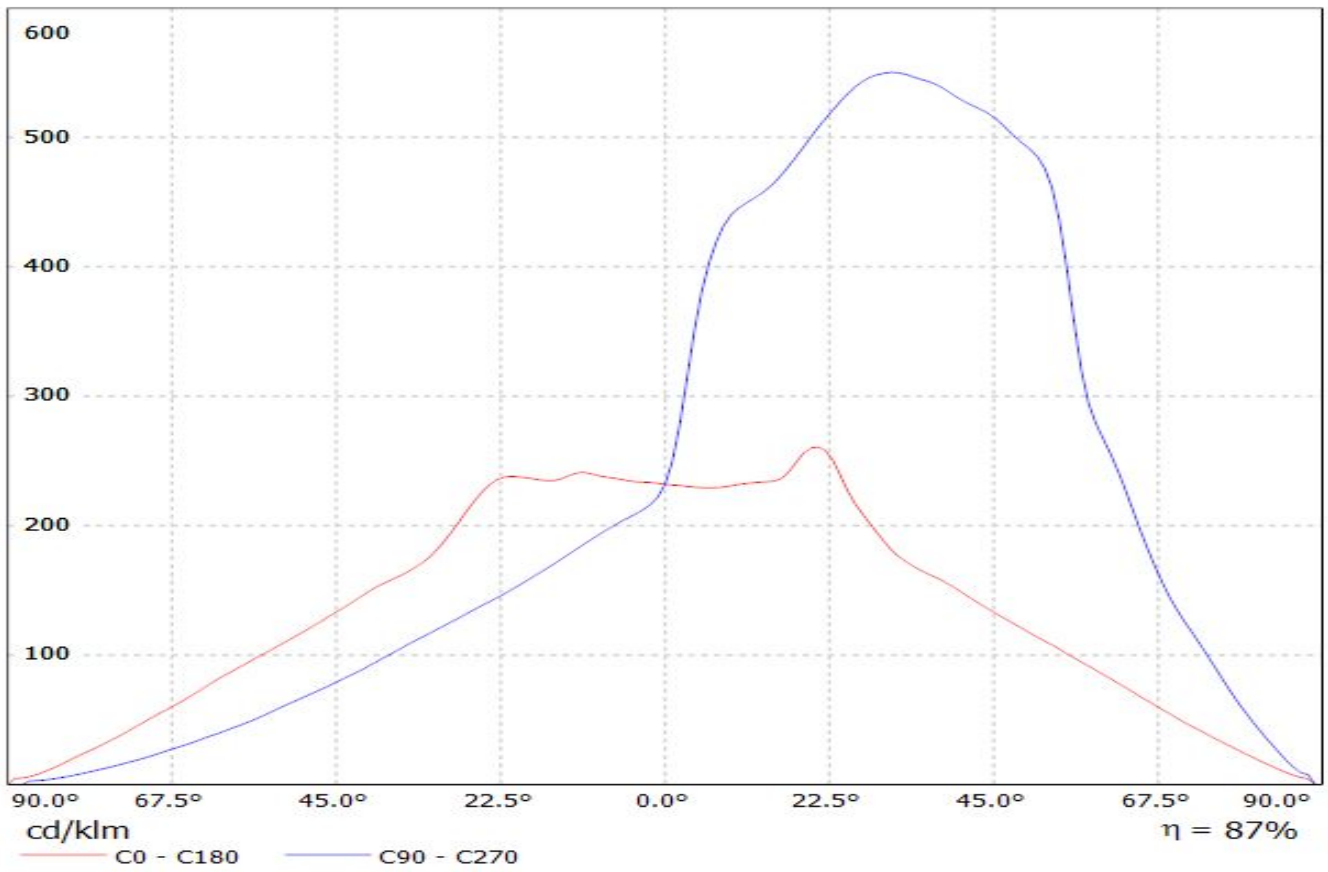

Luminaire: Ledil Oy CA12514_RITA-A_(Luxeon-A) Efficiency=87%
Lamps: 1 x Luxeon A 64lm@250mA CCT=2900K P=0.8W I=250mA

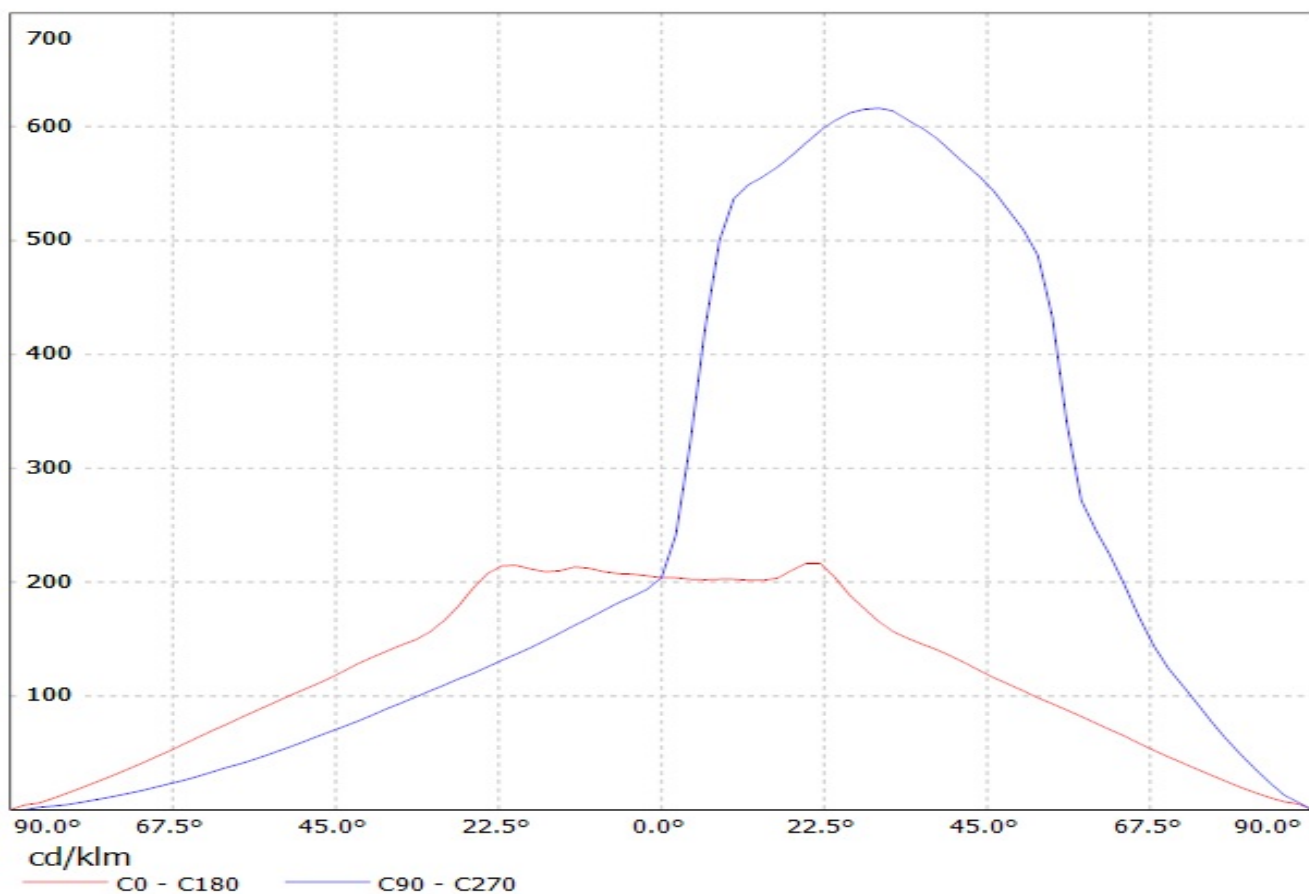

Luminaire: Ledil Oy CA12514_RITA-A (Luxeon Rebel (82lm @ 250mA)) Efficiency=87%
Lamps: 1 x Luxeon Rebel (82lm @ 250mA)

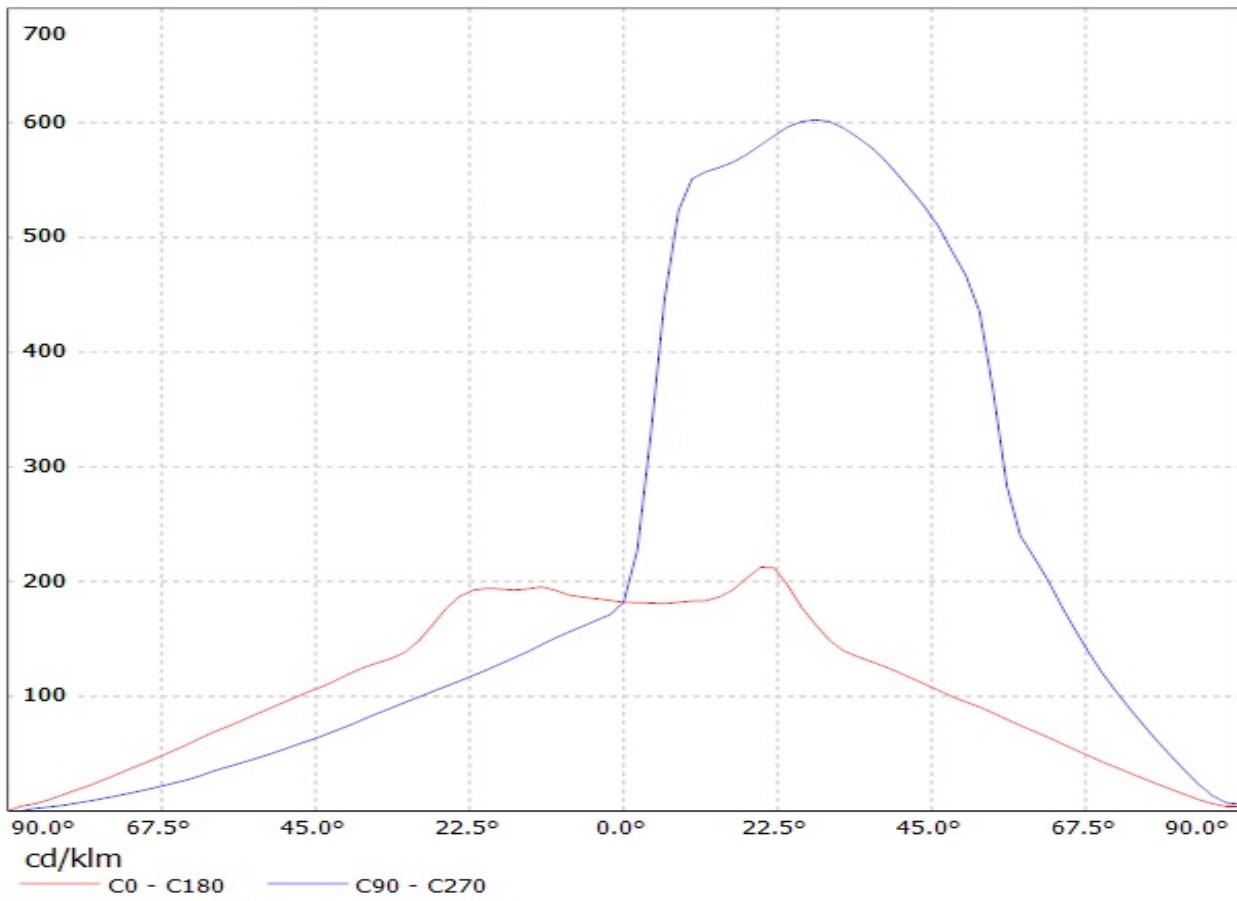

Luminaire: Ledil Oy CA12514_RITA-A_(Luxeon-T) Efficiency=87%
Lamps: 1 x Luxeon T (LHX8-FW30-3) 71lm@250mA CCT=3158K P=0.8W I=250mA

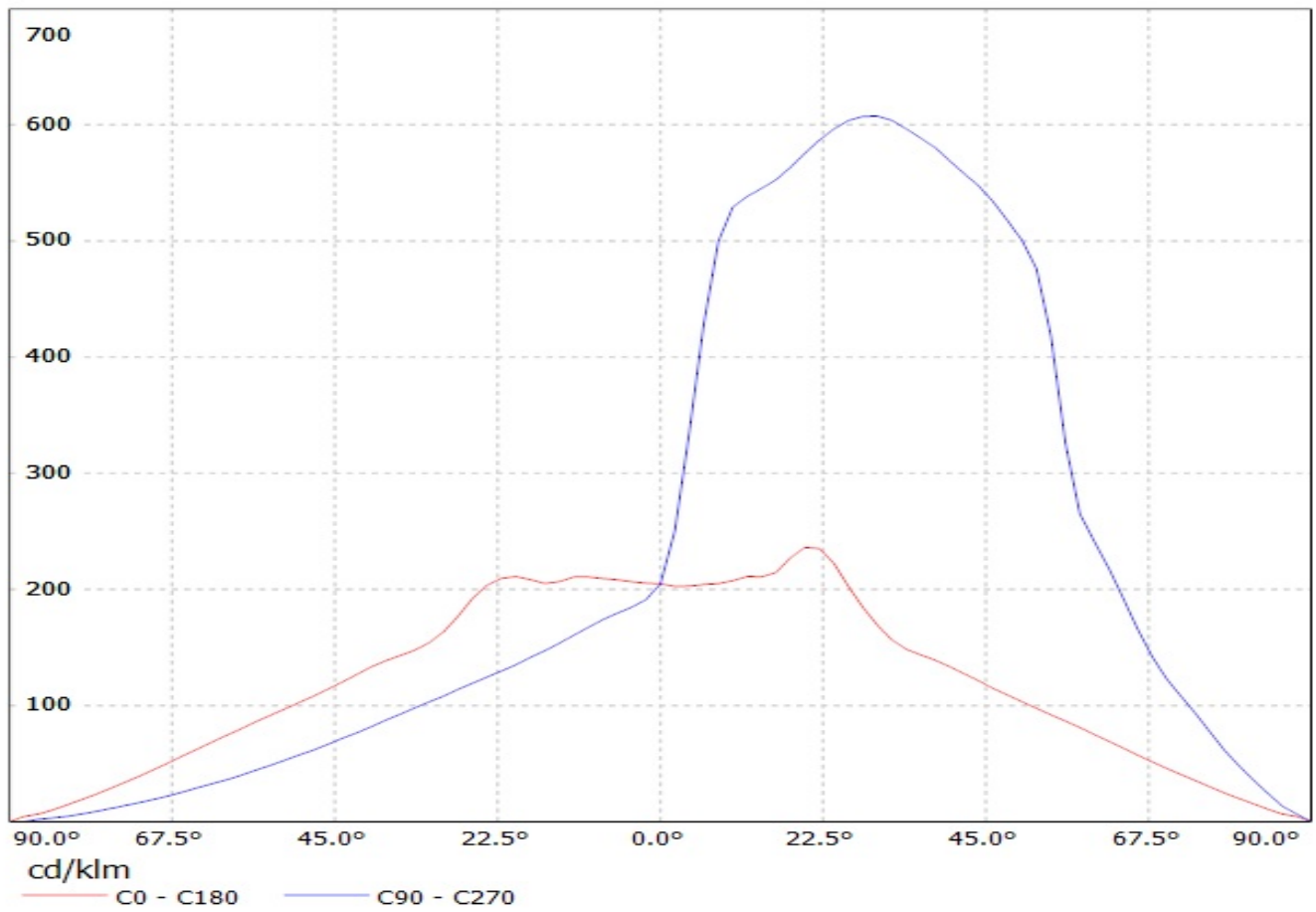

Luminaire: LEDiL Oy CA12514_RITA-A_(Luxeon_TX) Eff.87.3%
Lamps: 1 x Luxeon_TX_(L1T2-3585)_80.1801lm@250mA_CCT=3500K_P=0.731482W_I=249.9mA

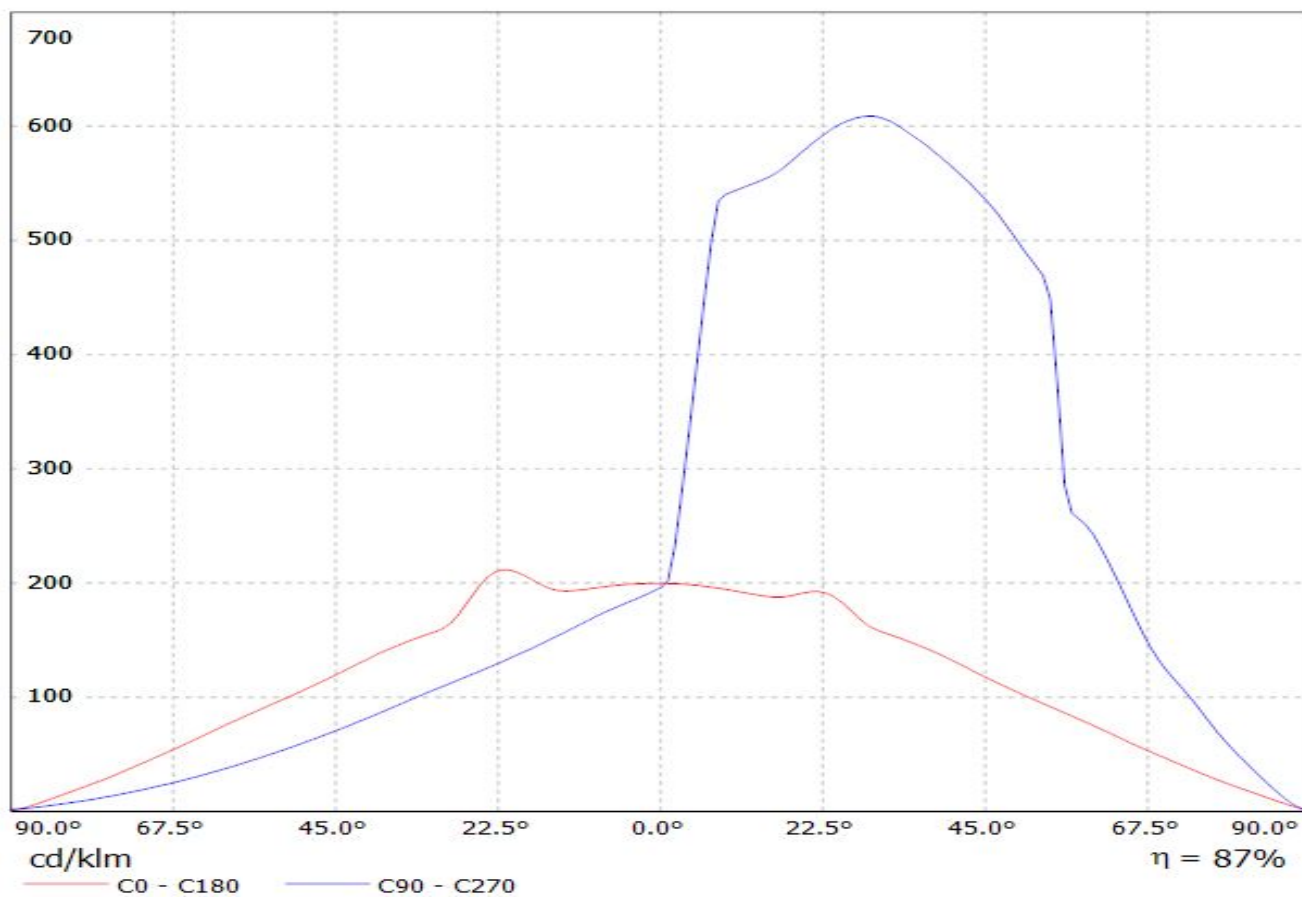

Luminaire: Ledil Oy CA12514_RITA-A_(NVS19) Efficiency=86%
Lamps: 1 x Nichia NVS19 99lm@250mA CCT=5320K P=0.7W I=250mA

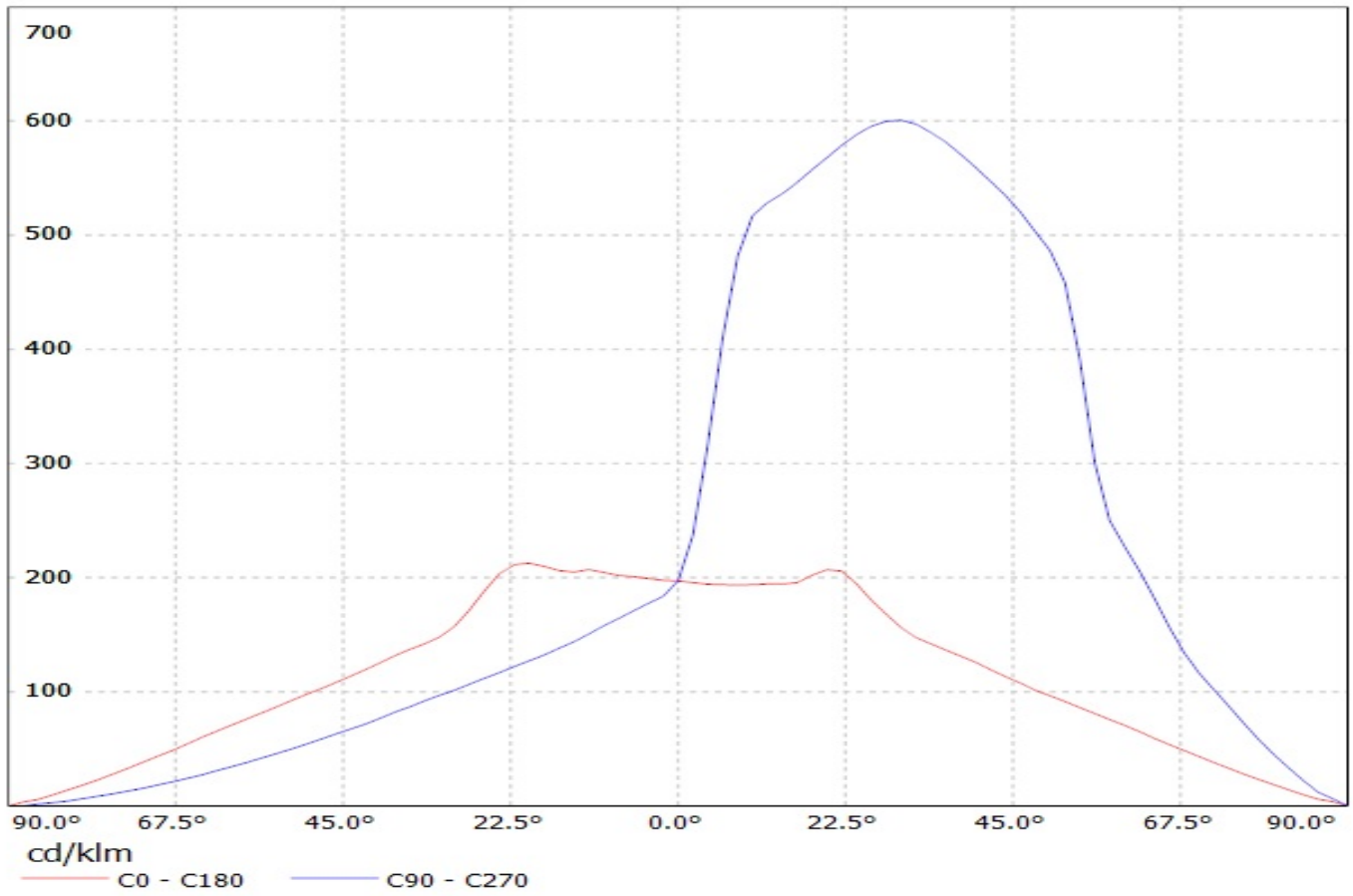

Luminaire: Ledil Oy CA12514_RITA-A_(NCS19) Efficiency=86%
Lamps: 1 x Nichia NCS19 47.3lm@250mA CCT=3201K P=0.8W I=250mA

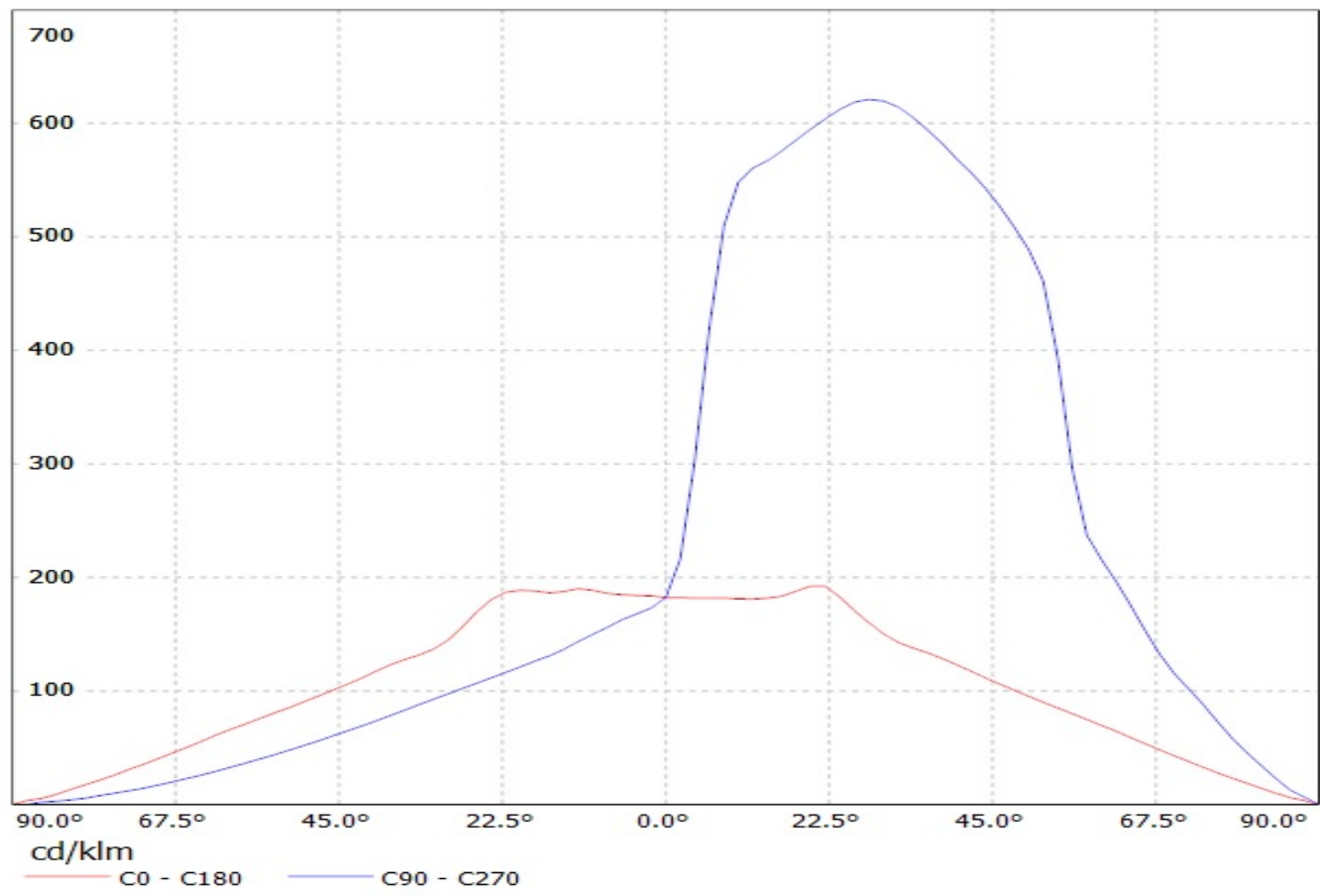

Luminaire: LEDiL Oy CA12514_RITA-A_(NS9x383) Eff. 86,8%
Lamps: 1 x Nichia NS9x383 (105lm@250mA)

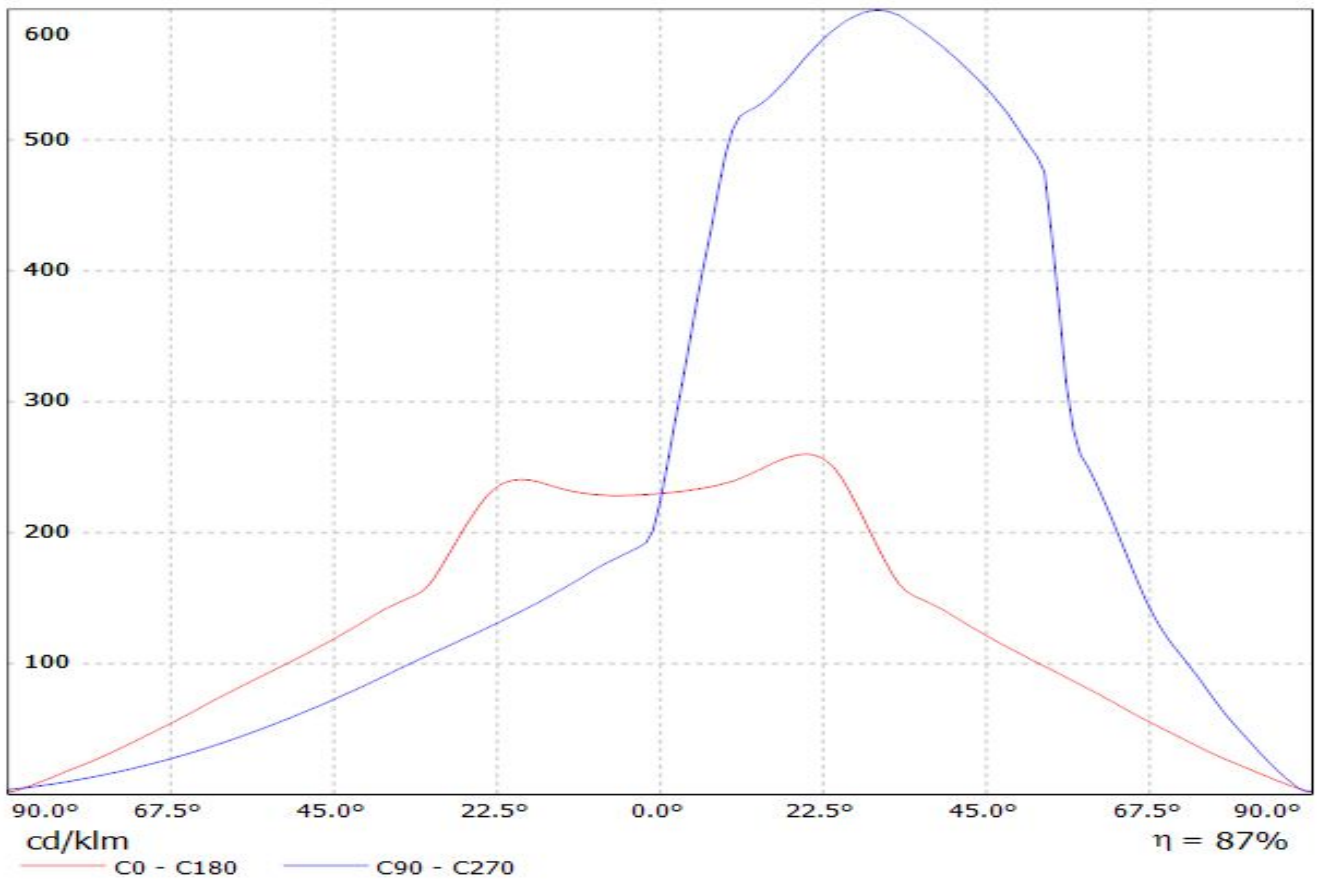

Luminaire: LEDiL Oy CA12514_RITA-A_(NVSL219CE)
Lamps: 1 x Nichia_NVSL219CE_101.227lm@250mA_P=0.713404W_I=0.25A

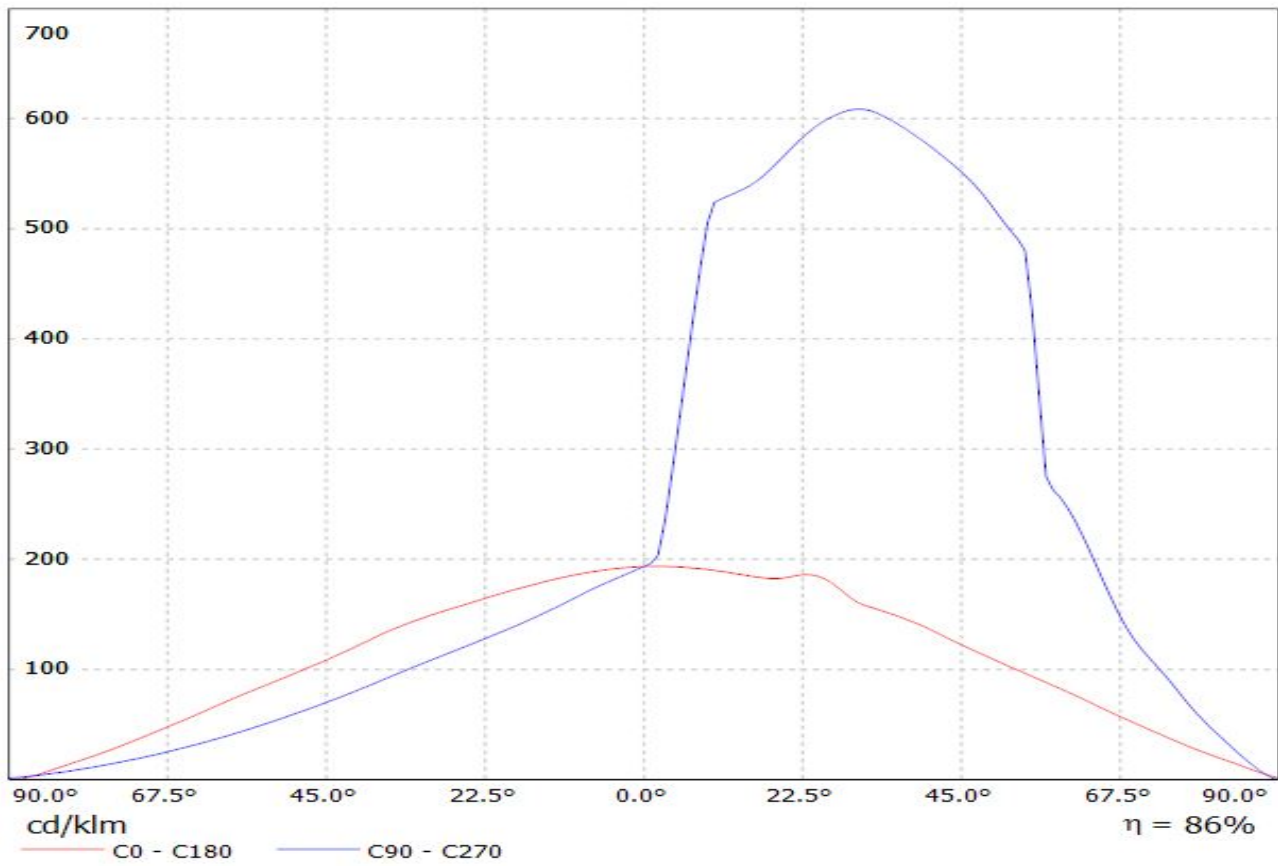

Luminaire: Ledil Oy CA12514_RITA-A_(SSL80) Efficiency=87%
Lamps: 1 x Osram Oslon SSL 80 (79lm@250mA) CCT= P=0.8W I=250mA

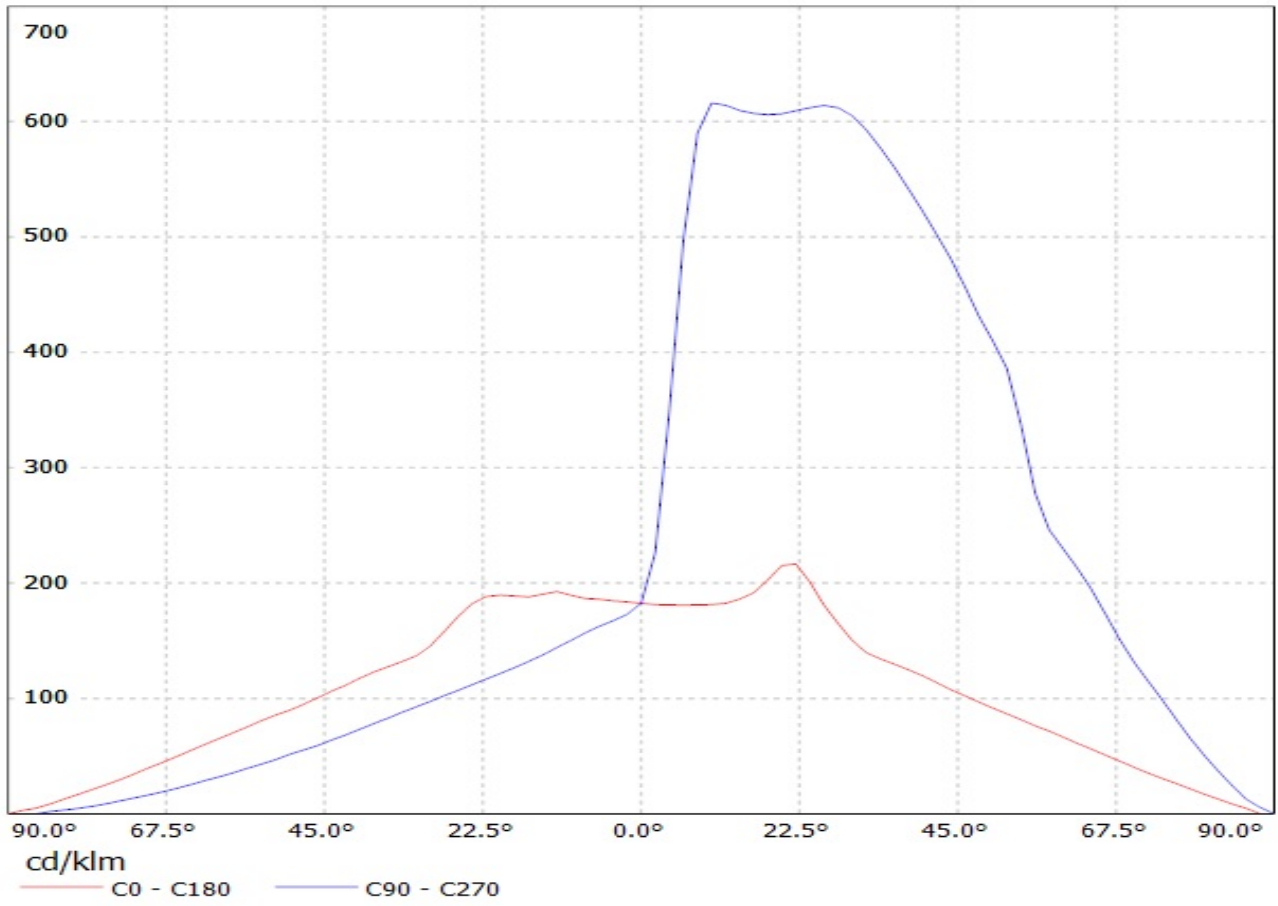

Luminaire: LEDil Oy CA12514_RITA-A (OSRAM Oslon SSL 150 (72 lm @ 250 mA)) Efficiency=86%
Lamps: 1 x OSRAM Oslon SSL 150 (72 lm @ 250 mA)

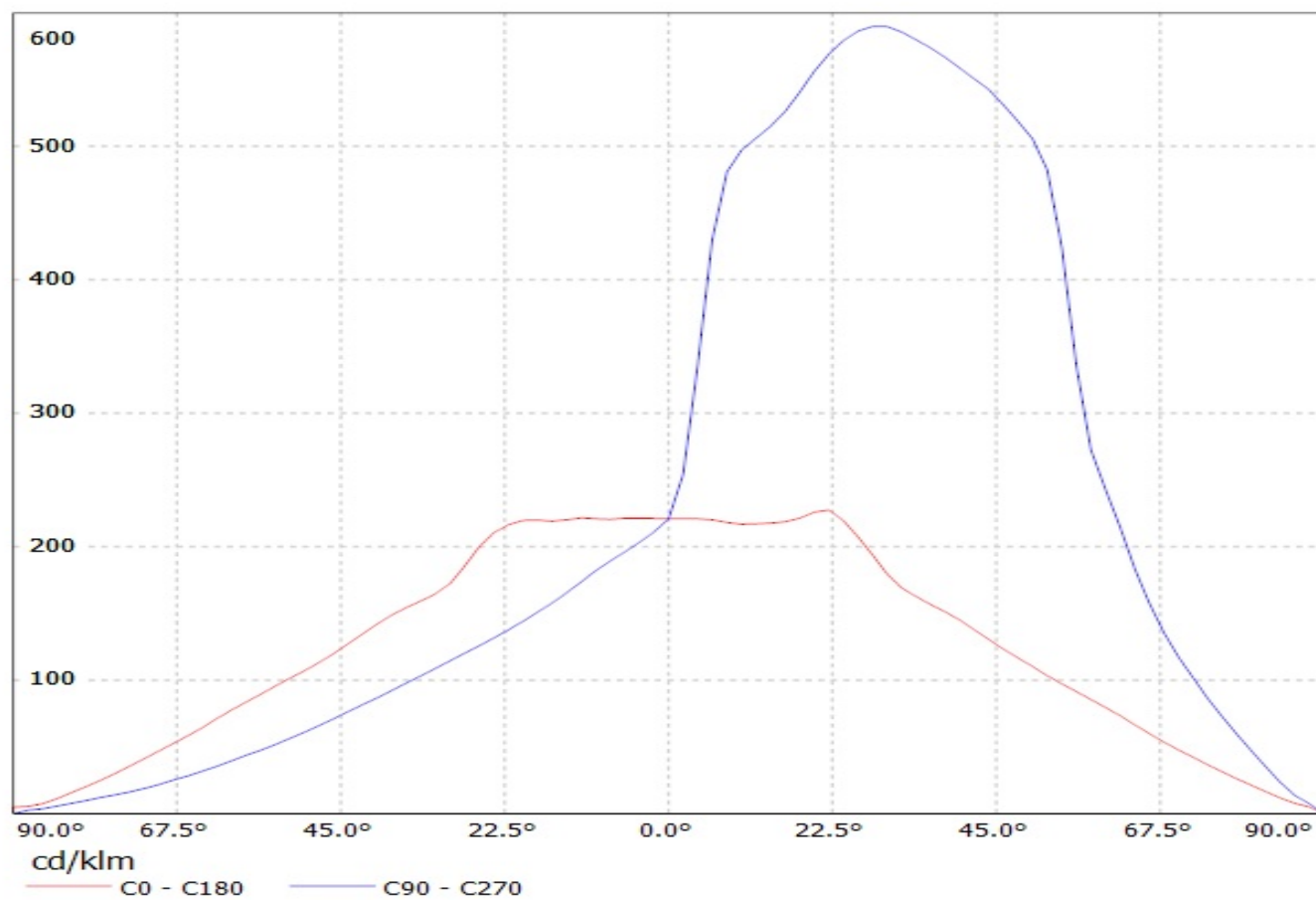

Luminaire: Ledil Oy CA12514_RITA-A (XP-G) CA12514_RITA-A (XP-G) Efficiency=86%
Lamps: 1 x CREE XP-G (white)

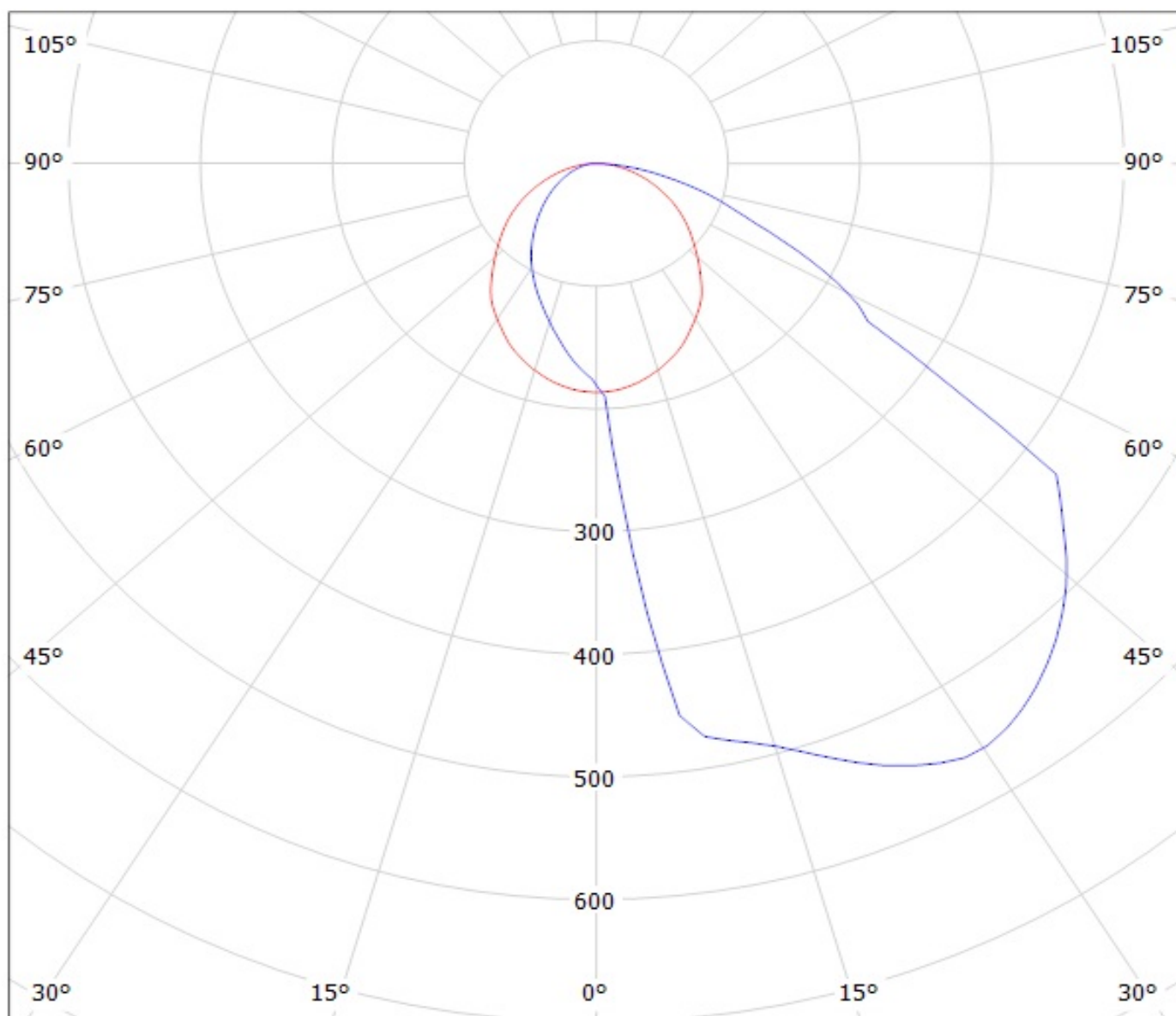

cd/klm

— C0 - C180

— C90 - C270

Luminaire: Ledil Oy CA12514_RITA-A (XT-E) CA12514_RITA-A (XT-E) Efficiency=86%
Lamps: 1 x Cree XT-E white 108lm @ 250mA

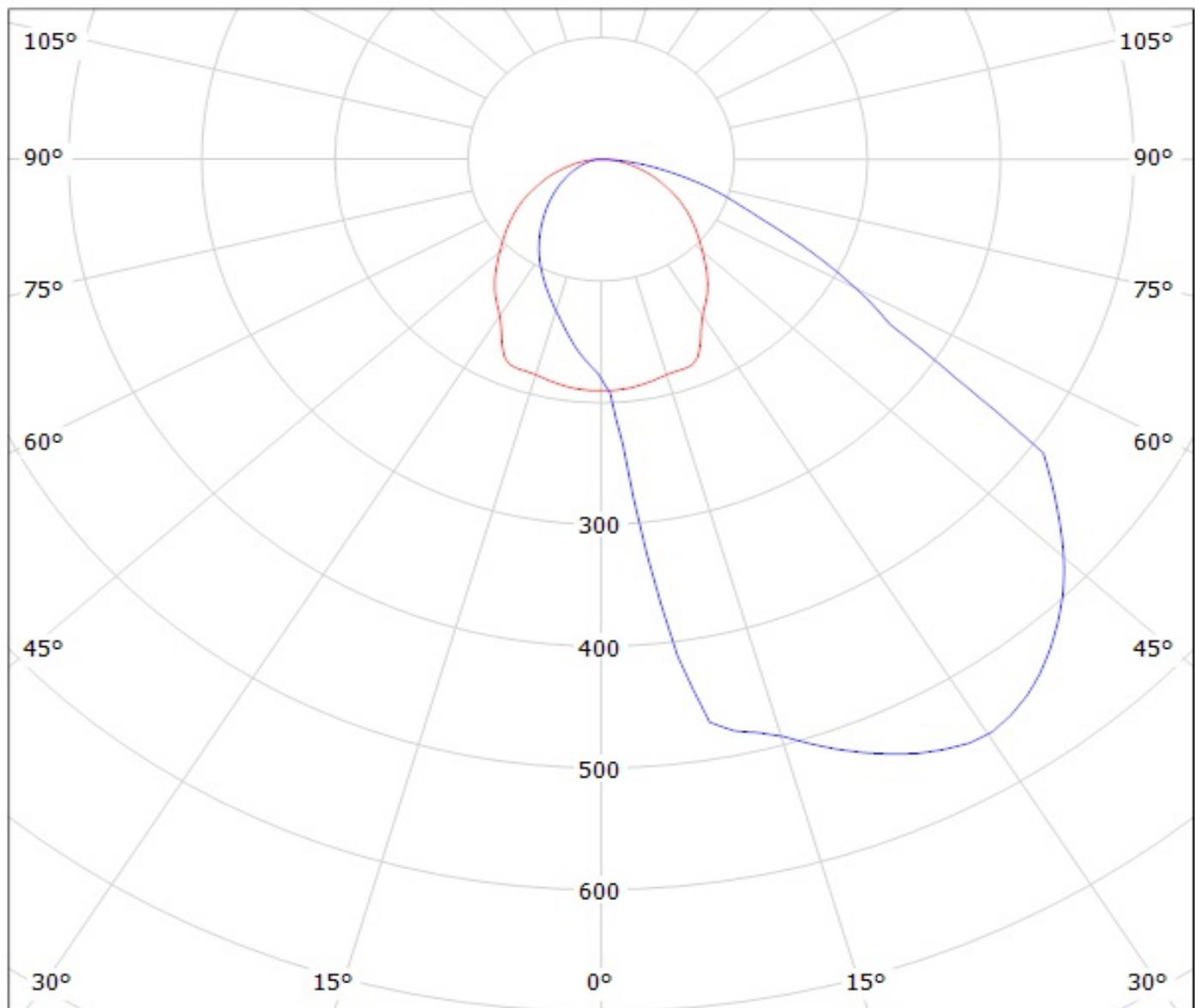

cd/klm

— C0 - C180

— C90 - C270

Luminaire: Ledil Oy CA12514_RITA-A_XB-D CA12514_RITA-A_XB-D Efficiency 84%
Lamps: 1 x CREE XB-D

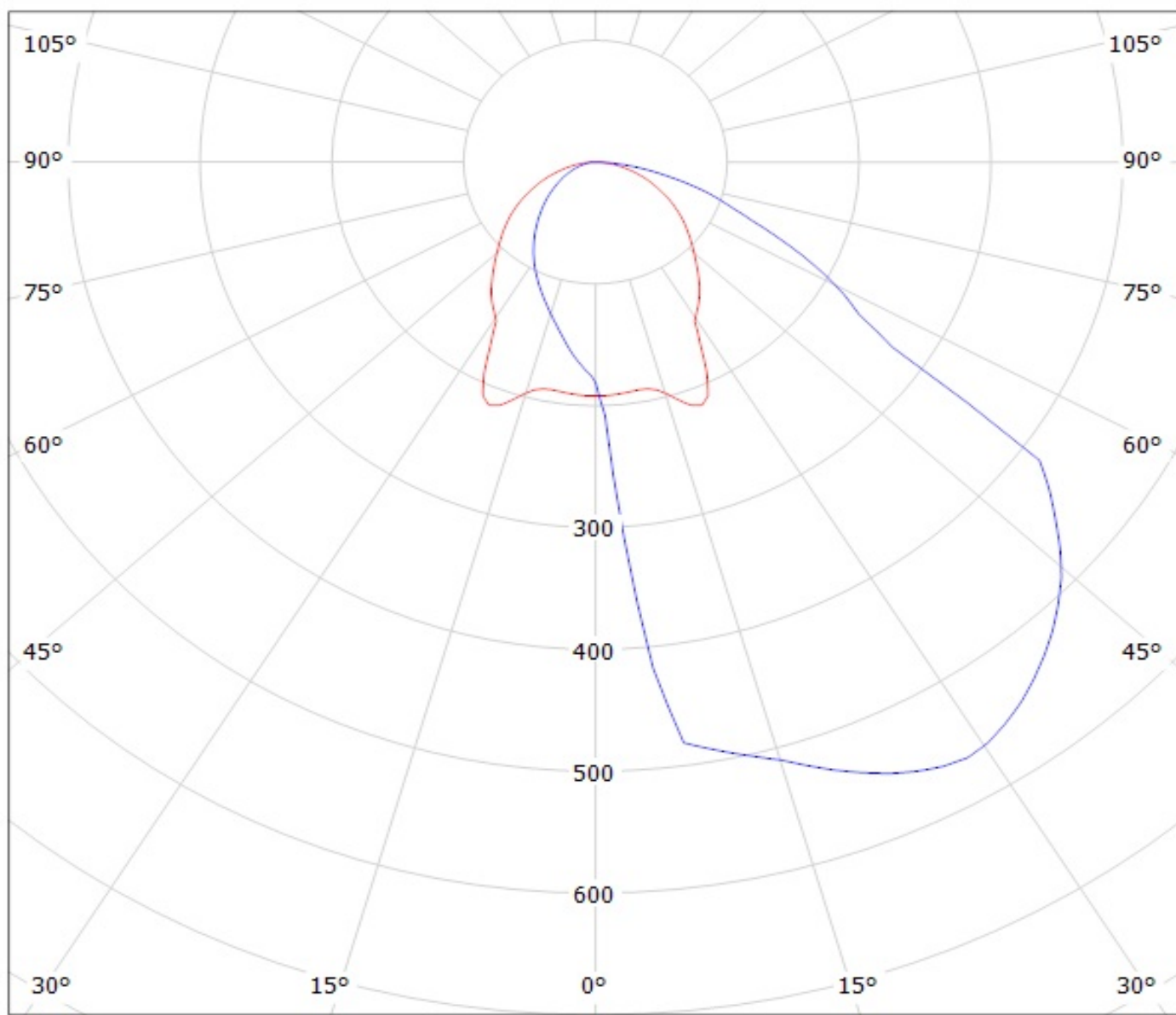

cd/klm

— C0 - C180

— C90 - C270

Luminaire: Ledil Oy C12512_RITA-A / CA12514_RITA-A (XM-L) Efficiency=85%
Lamps: 1 x Cree XM-L 87lm@250mA

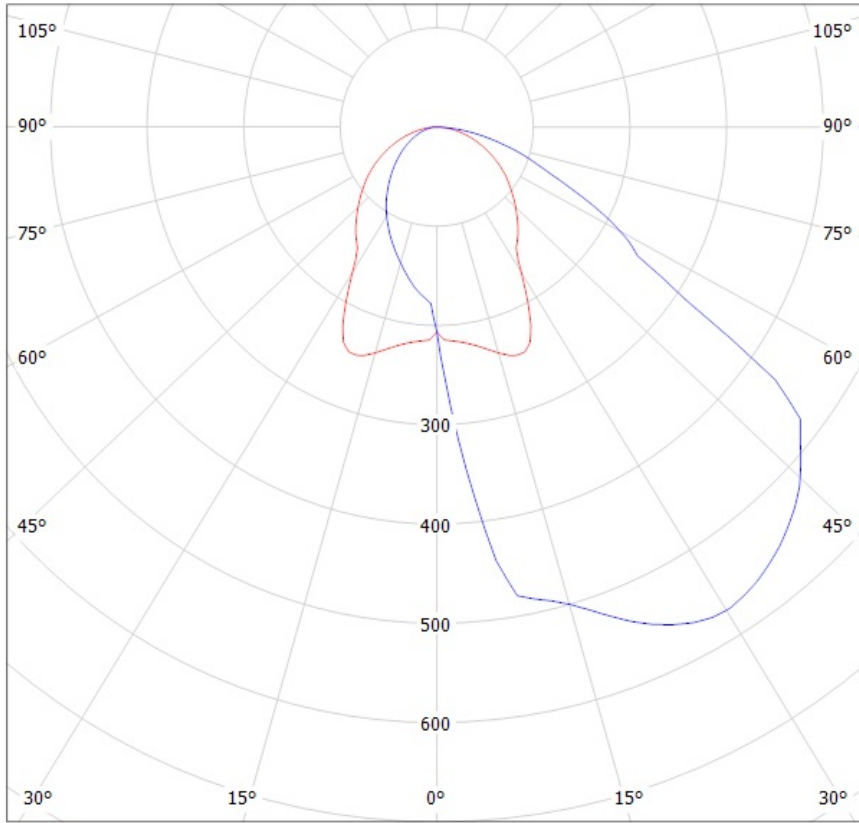

cd/klm

— C0 - C180 — C90 - C270

Luminaire: LEDil Oy CA12514_RITA-A_(XM-L2) Efficiency=86%
Lamps: 1 x Cree XM-L2 (XMLBWT-0-7B4-T30-0L-0001) 91lm @ 250mA CCT=3200K P=0.7W I=250mA

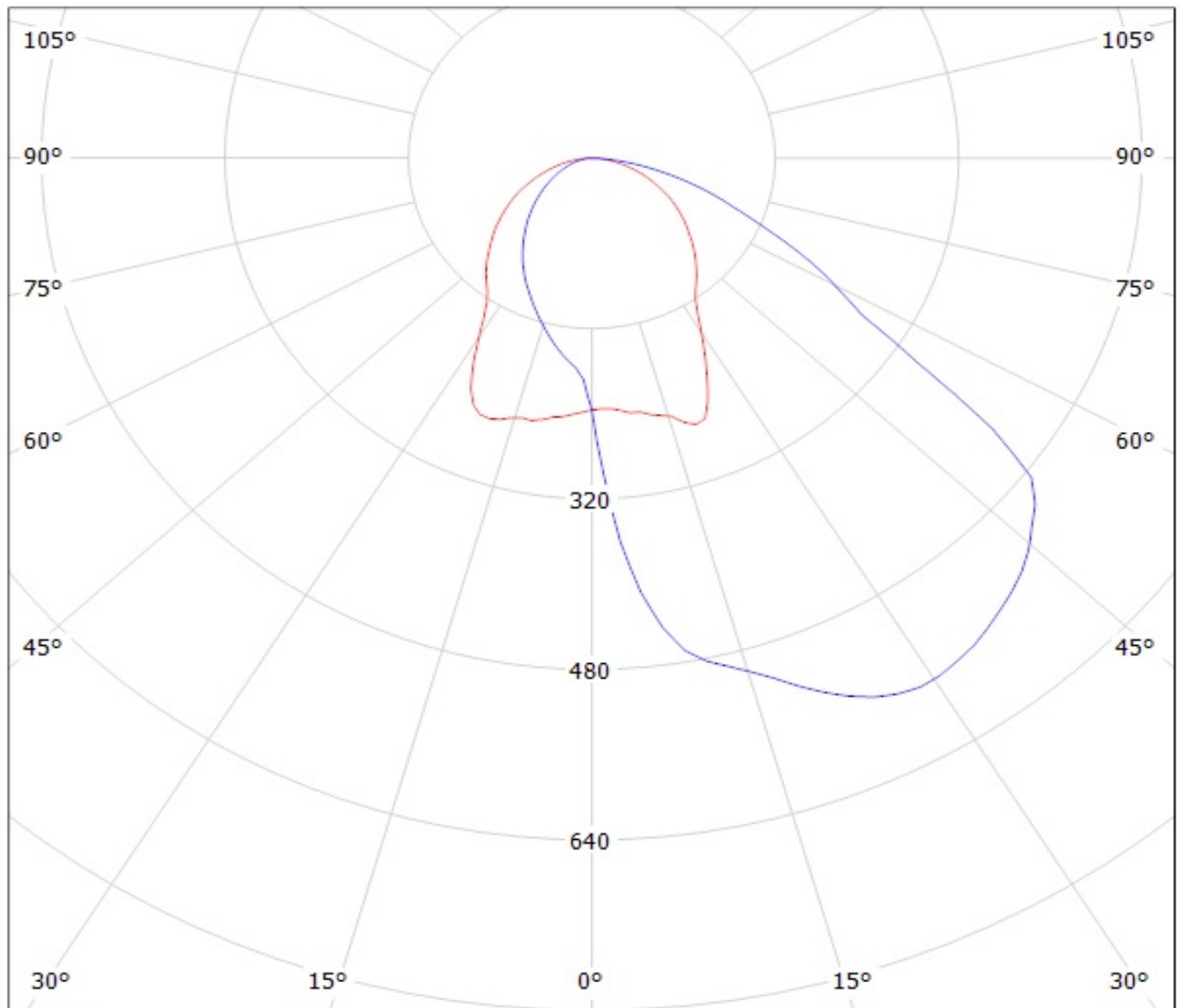

cd/klm

— C0 - C180

— C90 - C270

Luminaire: LEDil Oy RITA-A

Lamps: 1 x CREE xp-g2 101lm@250mA (XPGBWT-L1-0000-00FE4) CCT:5000K I:250mA

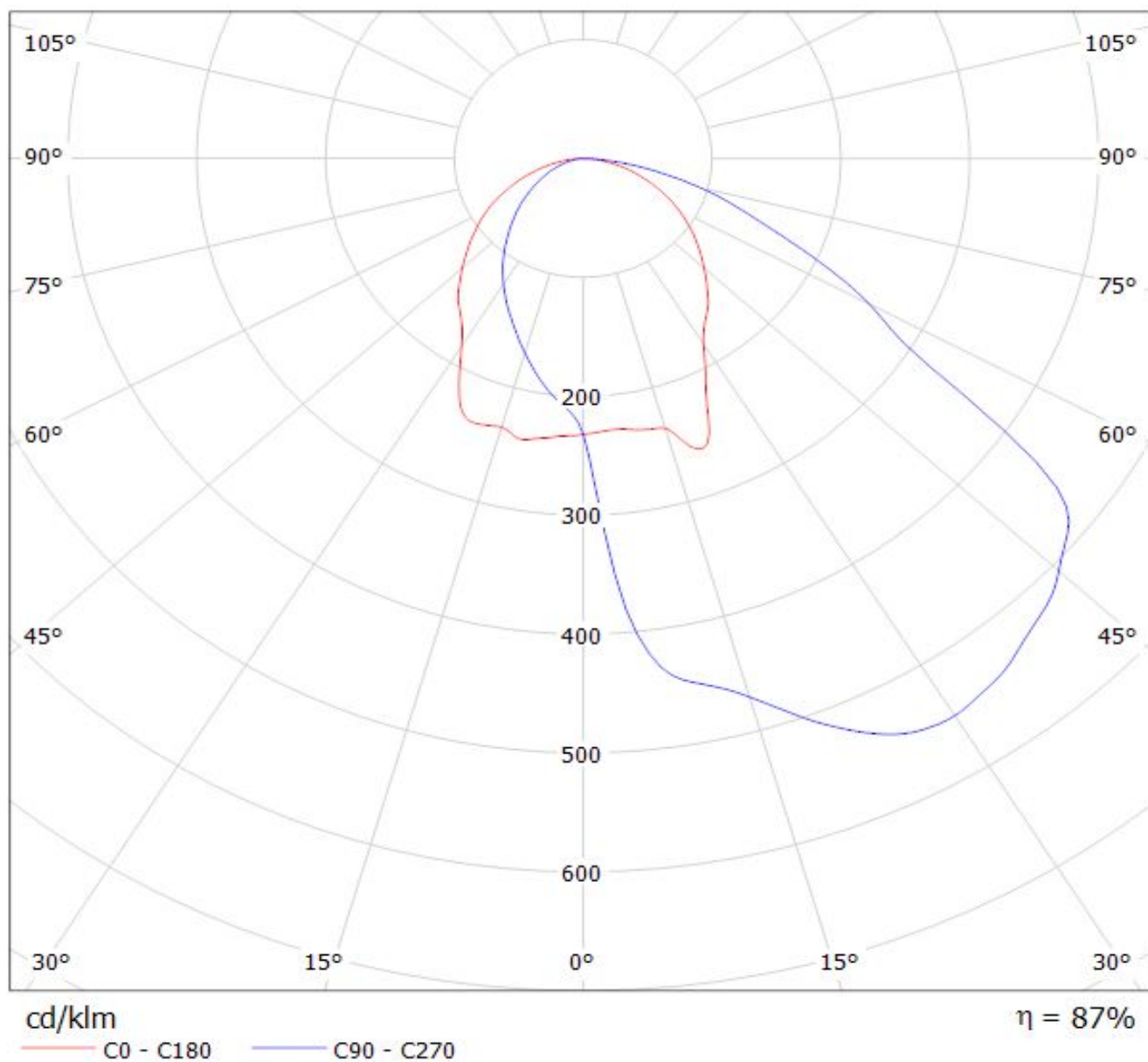

Luminaire: Ledil Oy CA12514_RITA-A_(Luxeon-A) Efficiency=87%
Lamps: 1 x Luxeon A 64lm@250mA CCT=2900K P=0.8W I=250mA

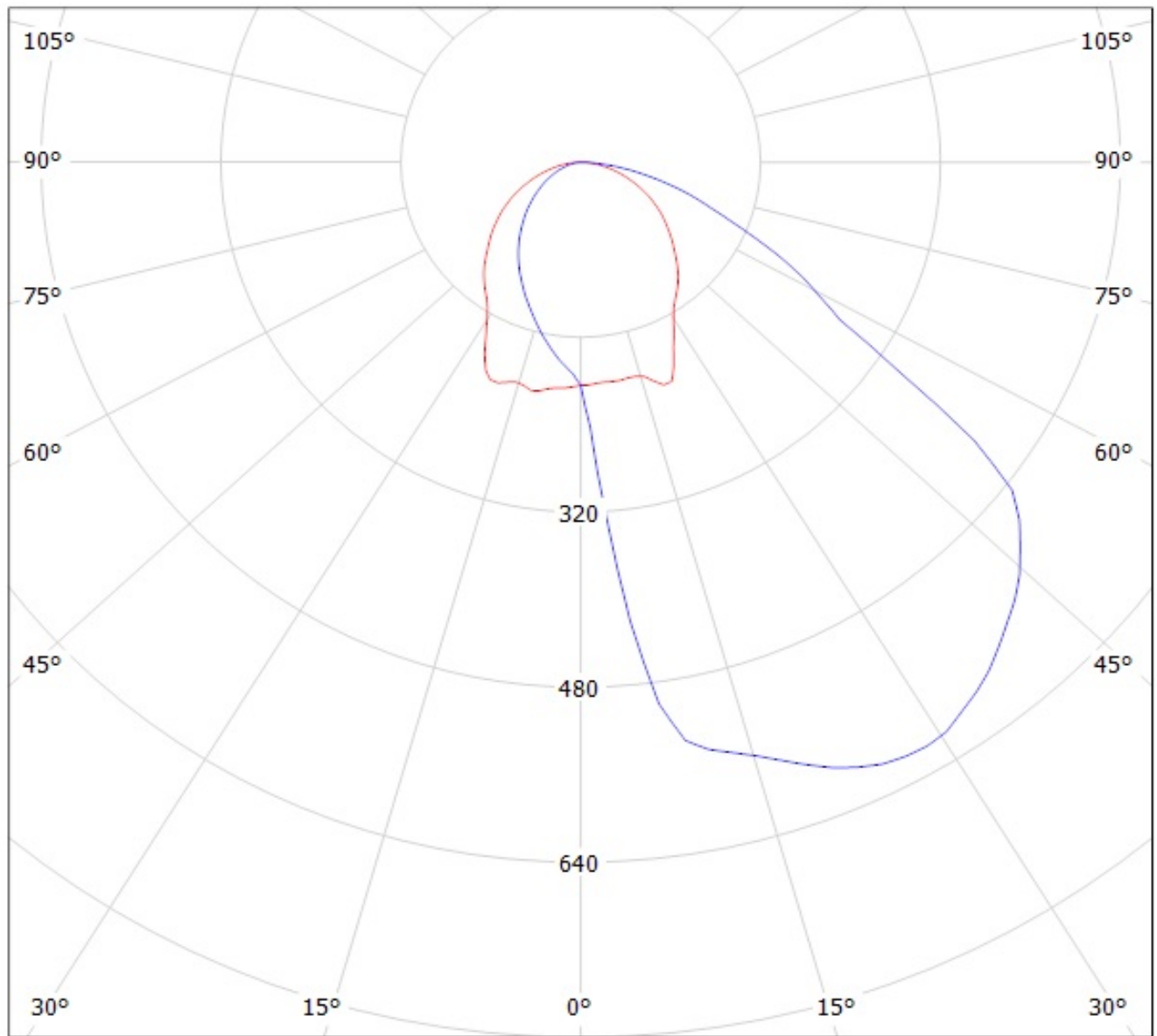

cd/klm

— C0 - C180

— C90 - C270

Luminaire: Ledil Oy CA12514_RITA-A_RE-ES CA12514_RITA-A_RE-ES efficiency = 85%
Lamps: 1 x Luxeon Rebel-ES

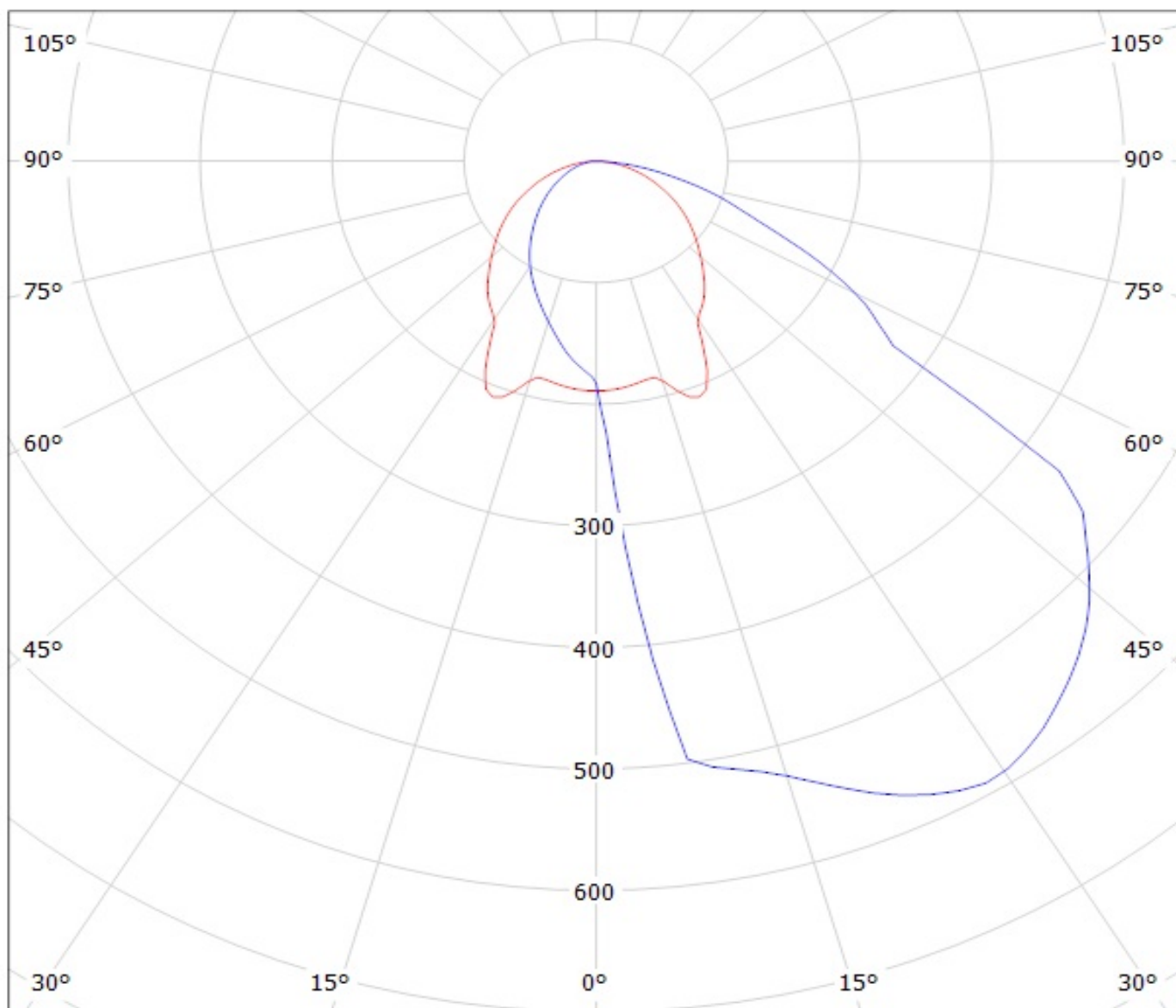

cd/klm

— C0 - C180

— C90 - C270

Luminaire: Ledil Oy CA12514_RITA-A (Luxeon Rebel (82lm @ 250mA)) Efficiency=87%
Lamps: 1 x Luxeon Rebel (82lm @ 250mA)

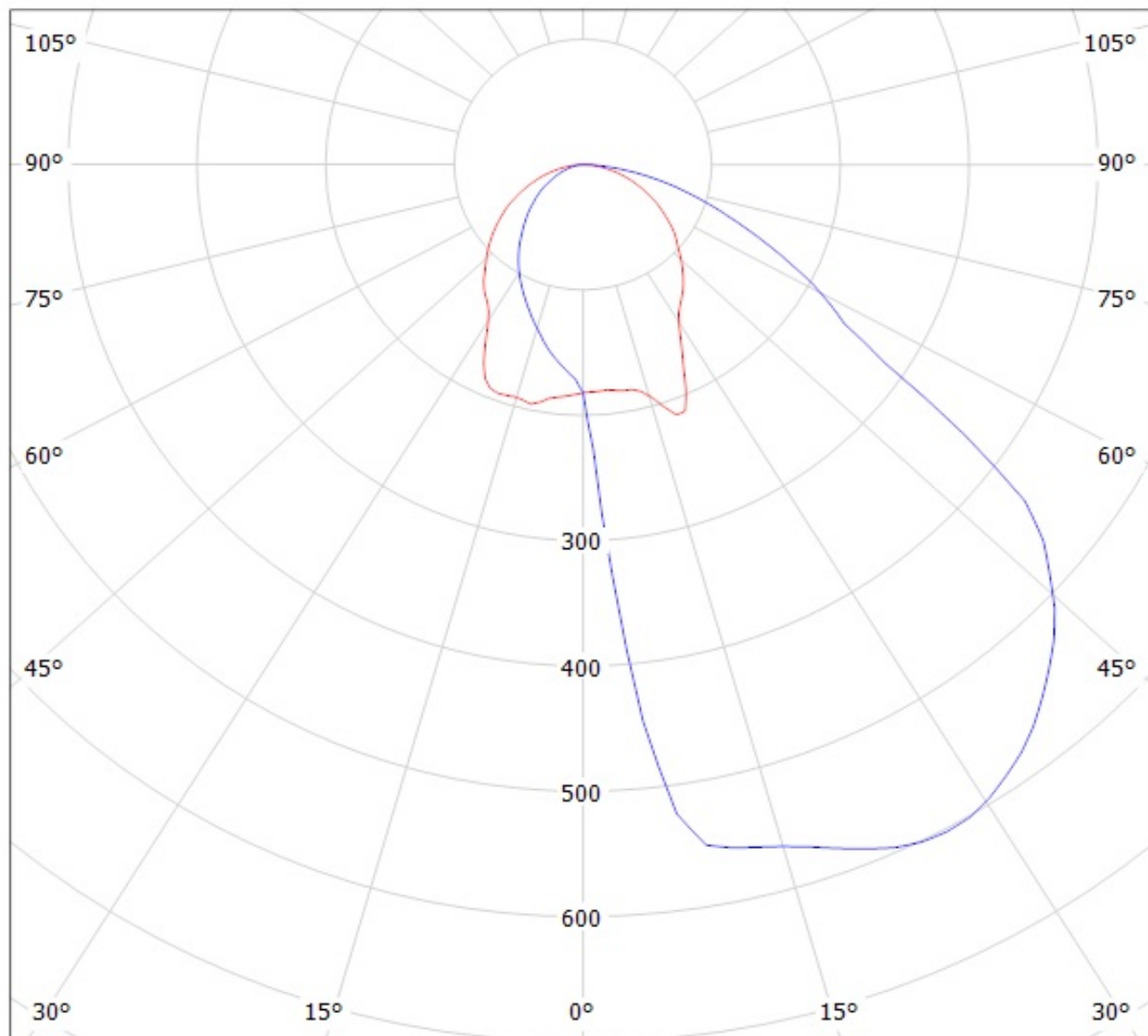

cd/klm

— C0 - C180

— C90 - C270

Luminaire: Ledil Oy CA12514_RITA-A_(Luxeon-T) Efficiency=87%
Lamps: 1 x Luxeon T (LHX8-FW30-3) 71lm@250mA CCT=3158K P=0.8W I=250mA

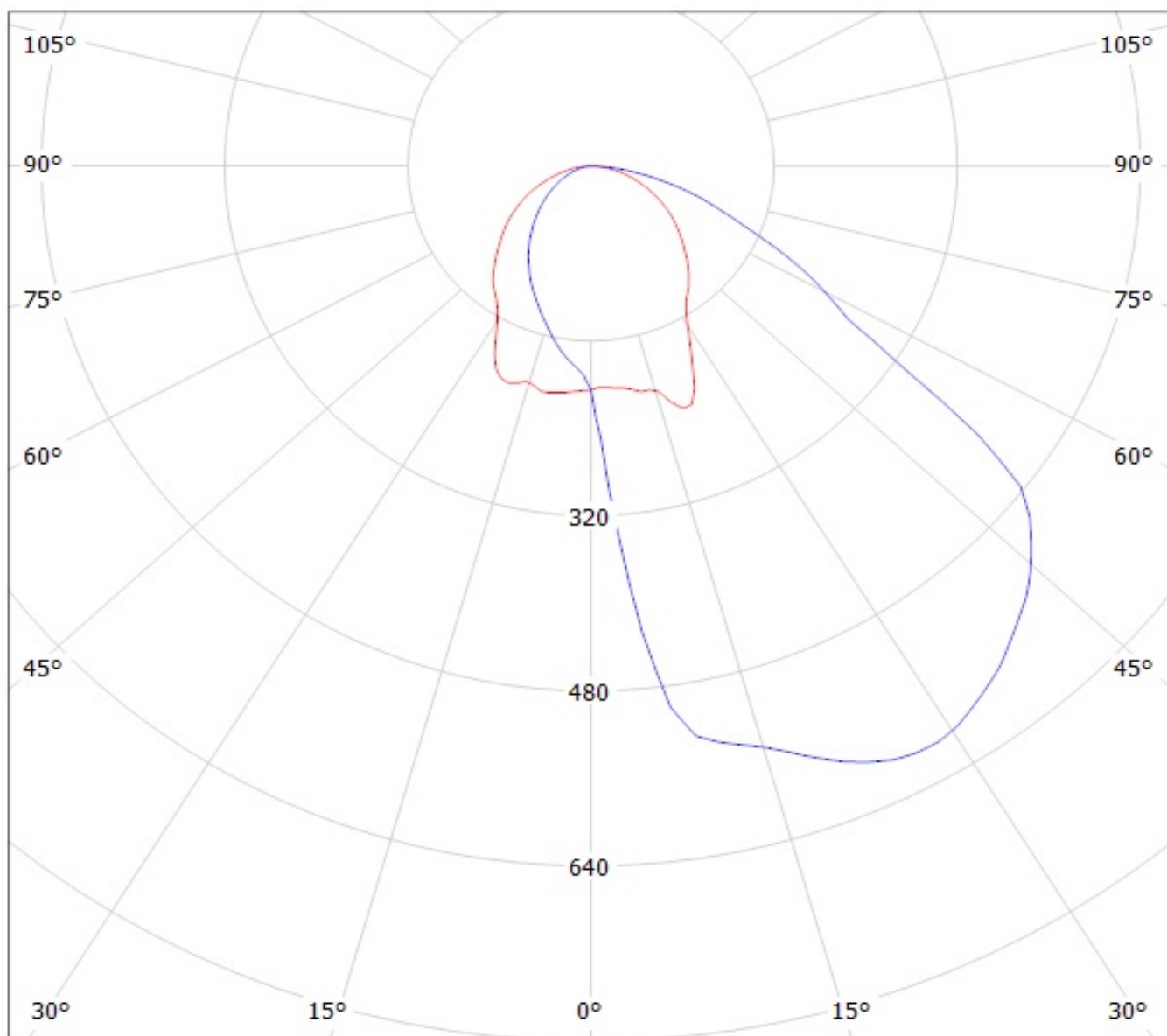

cd/klm

— C0 - C180 — C90 - C270

Luminaire: LEDiL Oy CA12514_RITA-A_(Luxeon_TX) Eff.87.3%

Lamps: 1 x Luxeon_TX_(L1T2-3585)_80.1801lm@250mA_CCT=3500K_P=0.731482W_I=249.9mA

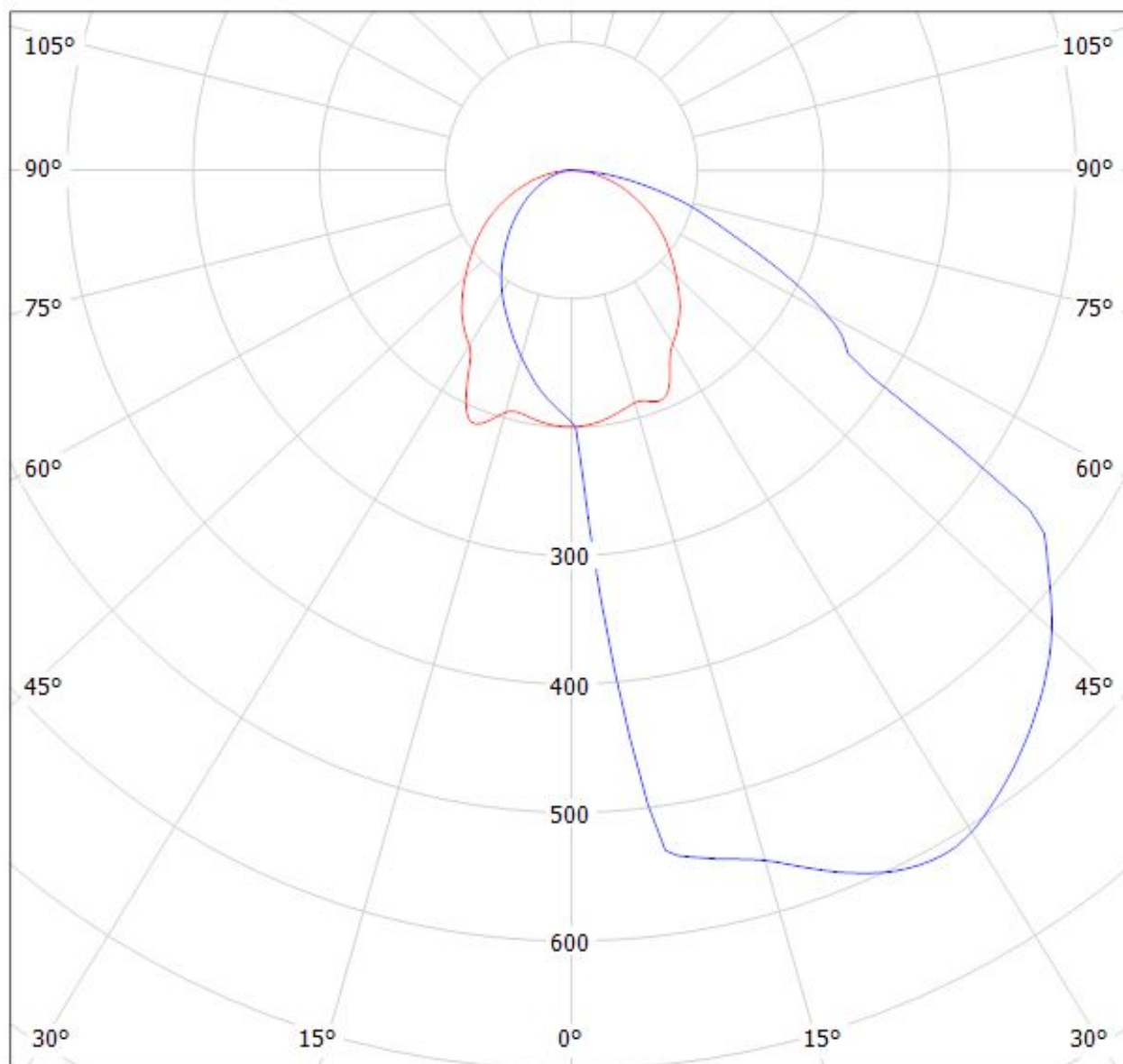

cd/klm

— C0 - C180

— C90 - C270

η = 87%

Luminaire: Ledil Oy CA12514_RITA-A_(NVS19) Efficiency=86%
Lamps: 1 x Nichia NVS19 99lm@250mA CCT=5320K P=0.7W I=250mA

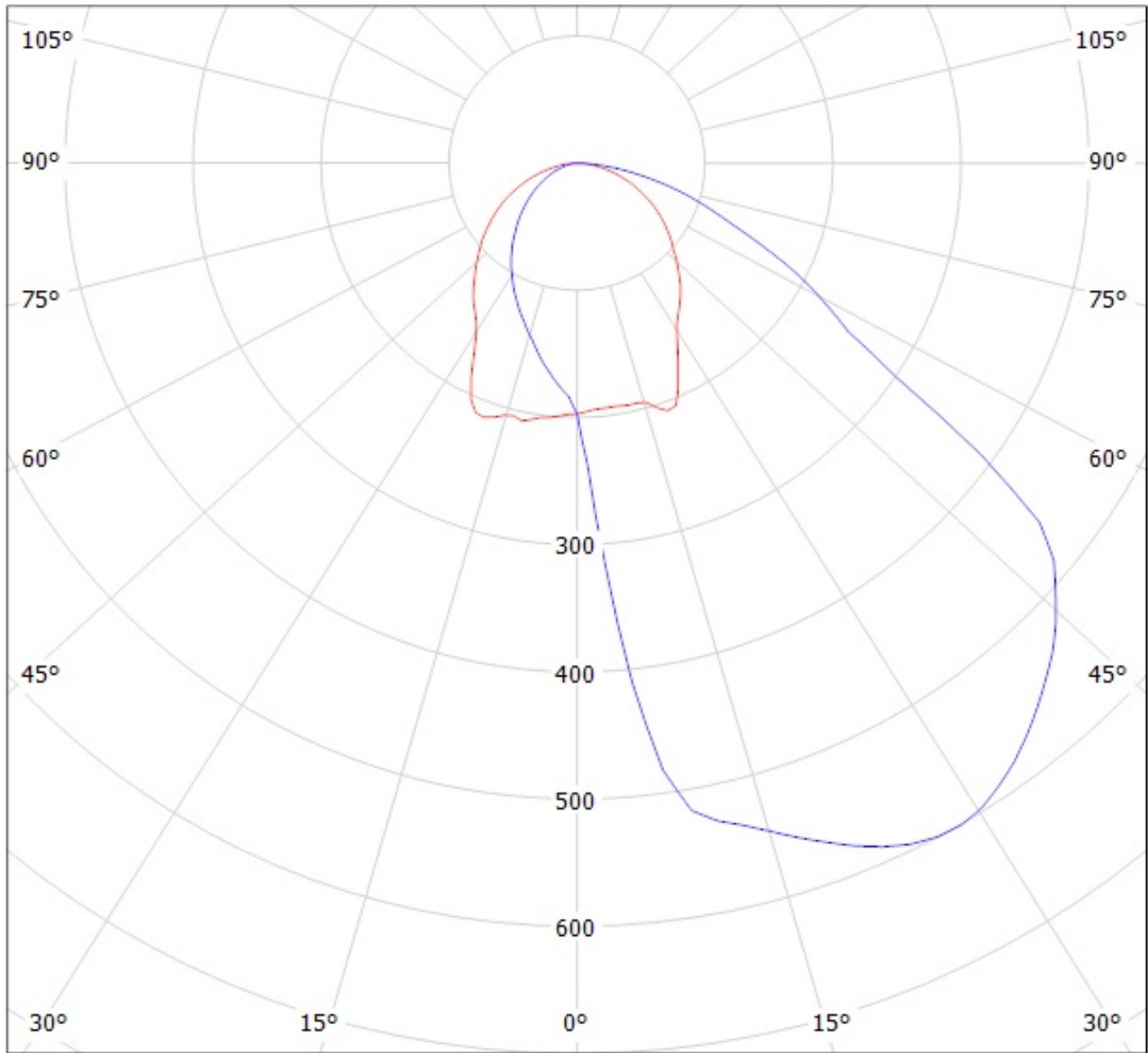

cd/klm

— C0 - C180

— C90 - C270

Luminaire: Ledil Oy CA12514_RITA-A_(NCS19) Efficiency=86%
Lamps: 1 x Nichia NCS19 47.3lm@250mA CCT=3201K P=0.8W I=250mA

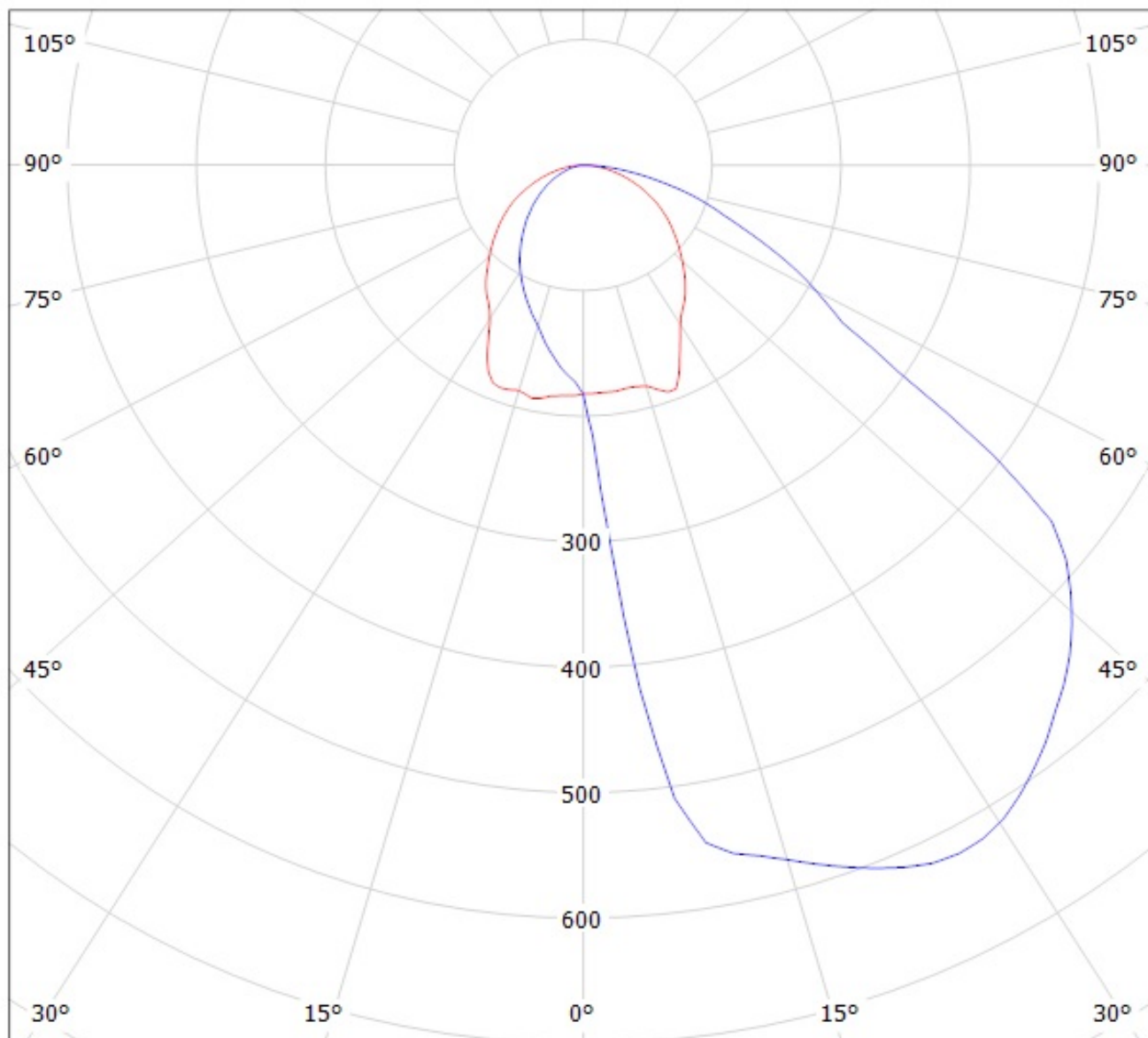

cd/klm

— C0 - C180 — C90 - C270

Luminaire: LEDiL Oy CA12514_RITA-A_(NS9x383) Eff. 86,8%
Lamps: 1 x Nichia NS9x383 (105lm@250mA)

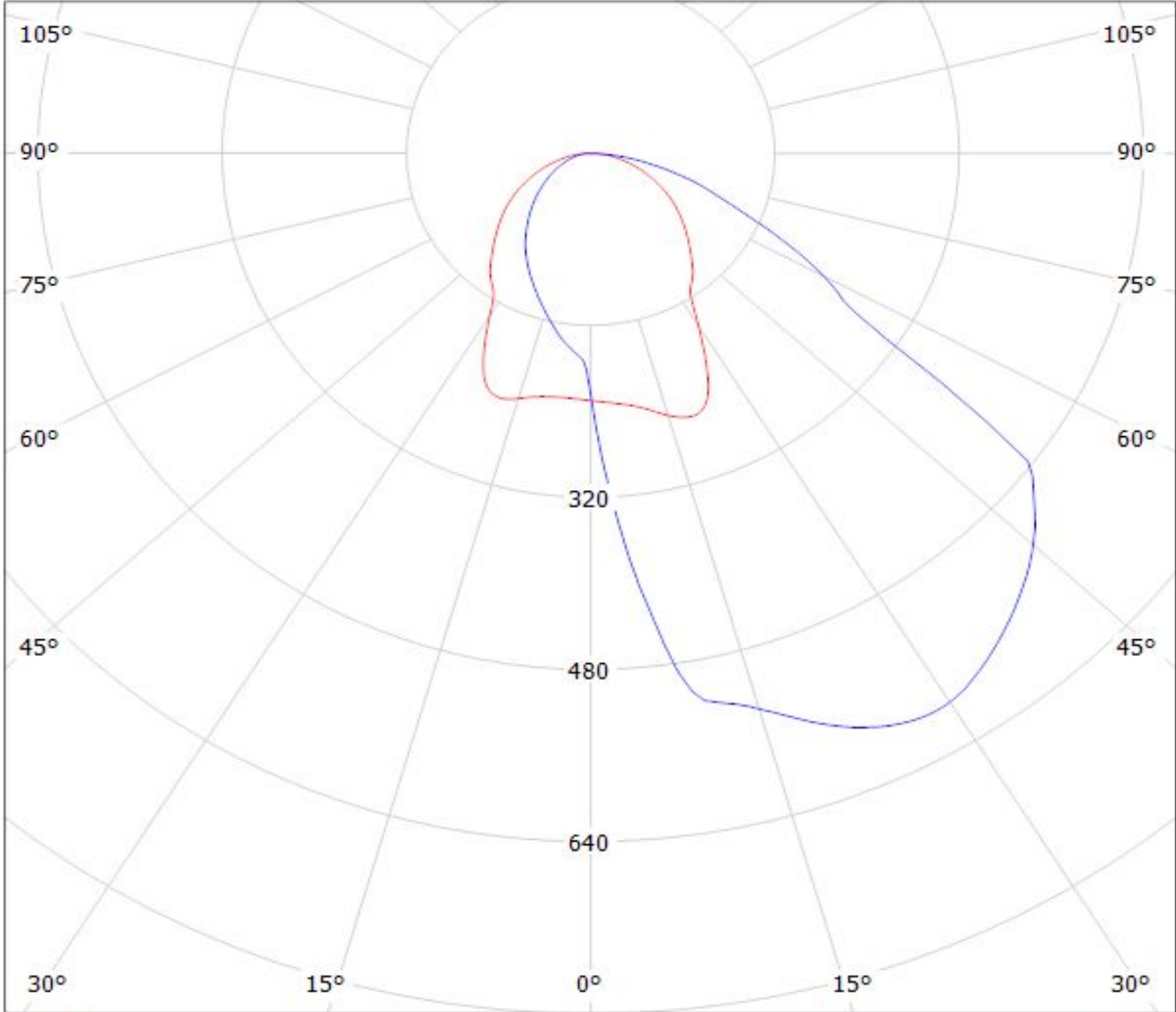

cd/klm

— C0 - C180

— C90 - C270

$\eta = 87\%$

Luminaire: LEDiL Oy CA12514_RITA-A_(NVSL219CE)

Lamps: 1 x Nichia_NVSL219CE_101.227lm@250mA_P=0.713404W_I=0.25A

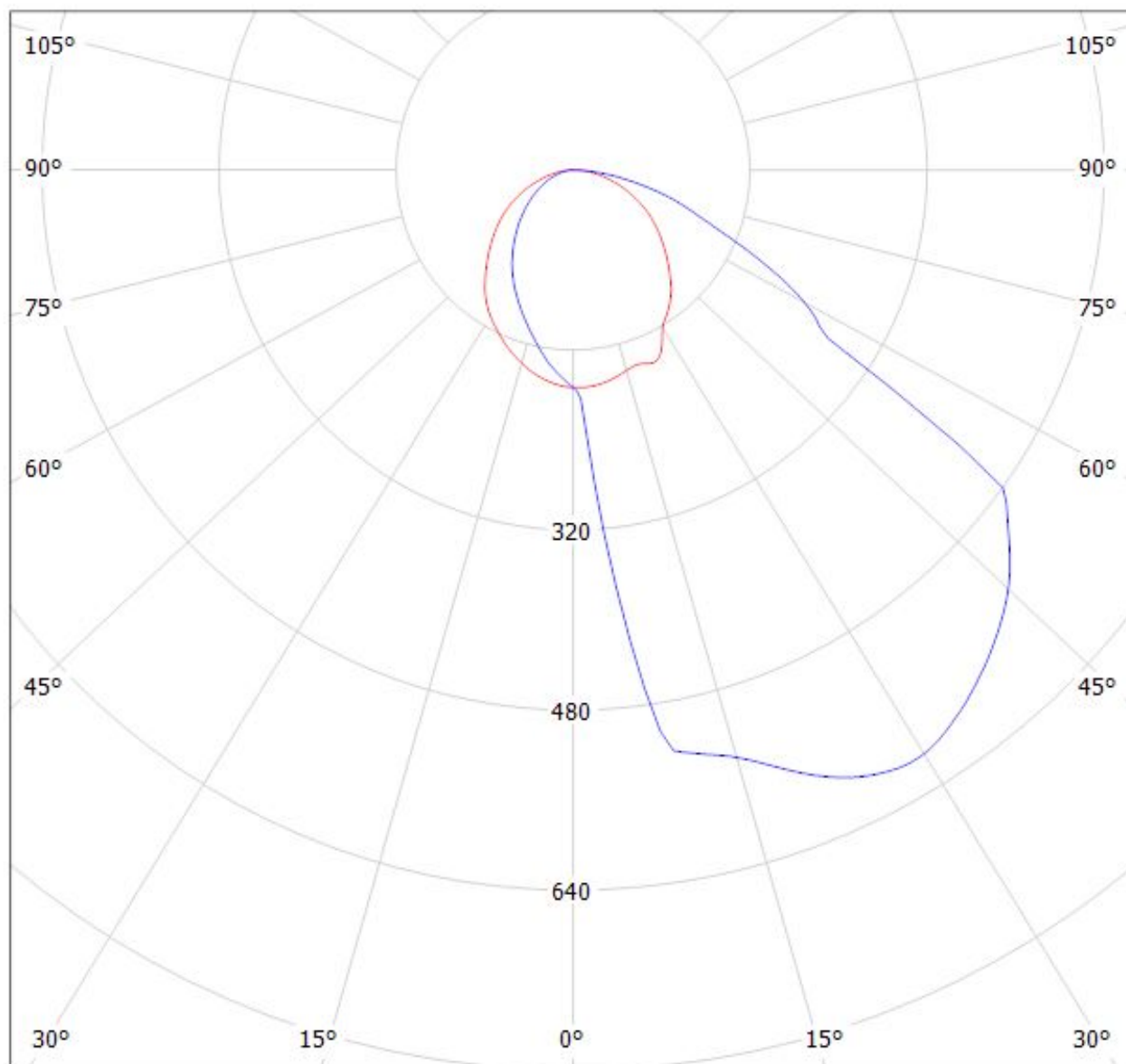

cd/klm

— C0 - C180 — C90 - C270

$\eta = 86\%$

Luminaire: Ledil Oy CA12514_RITA-A_(SSL80) Efficiency=87%
Lamps: 1 x Osram Oslon SSL 80 (79lm@250mA) CCT= P=0.8W I=250mA

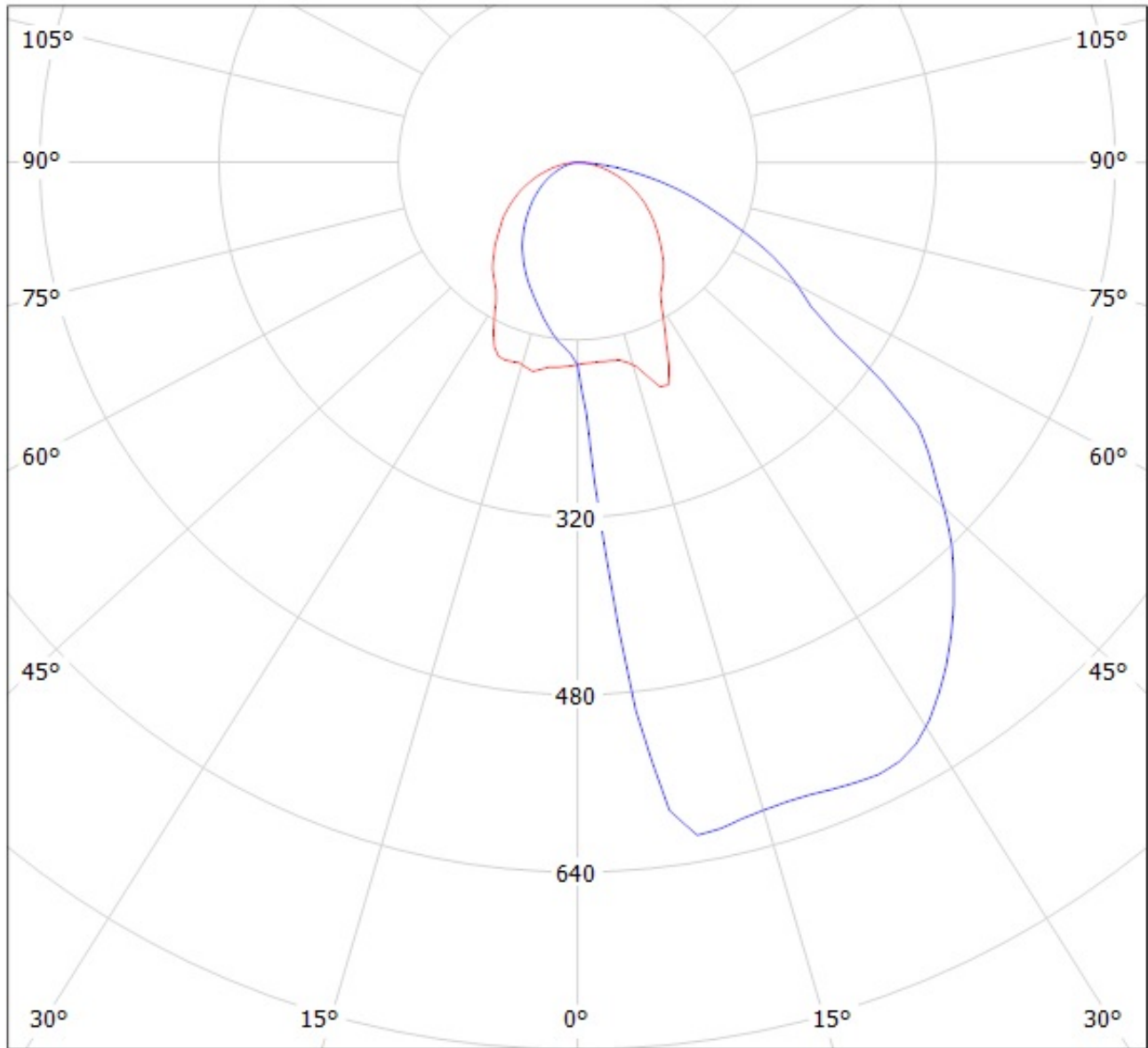

cd/klm

— C0 - C180

— C90 - C270

Luminaire: LEDil Oy CA12514_RITA-A (OSRAM Oslon SSL 150 (72 lm @ 250 mA)) Efficiency=86%
Lamps: 1 x OSRAM Oslon SSL 150 (72 lm @ 250 mA)

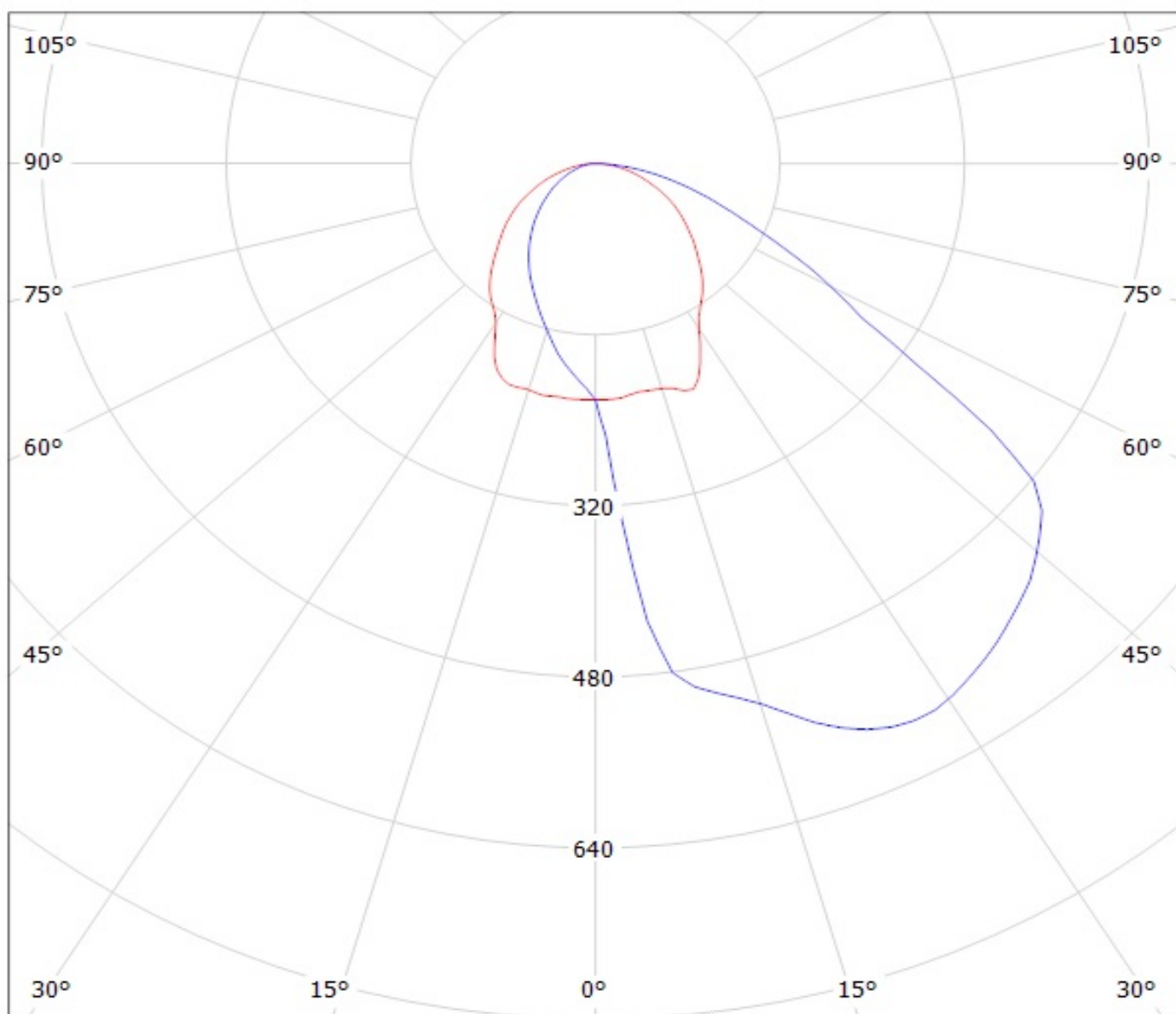

cd/klm

— C0 - C180

— C90 - C270

NOTE: The typical divergence will be changed by different color, chip size and chip position tolerance. The typical total divergence is the full angle measured where the luminous intensity is half of the peak value.