







XDSL SPLITTER FILTER MODULE



-  POTS Central Office Splitter for standard ADSL applications
-  For use with applications under BT-SIN-346 standard
-  This module is part of a standard series which has footprint compatibility
-  Patent pending
-  ADSL2+ compatible
-  NL version: RoHS-6 compliant

Electrical Specifications @ 25°C

PARAMETER	FREQUENCY	
POTS Impedance	100 Hz to 4 kHz	320 Ω + 1050 Ω / 230 nF
POTS Insertion Loss	1 kHz	-1.0 dB MAX
POTS Attenuation Distortion relative to 1kHz	200 Hz to 3.4 kHz	±1.0 dB MAX
POTS Return Loss	200 Hz to 2 kHz	-18 dB MIN
	2 kHz to 3.4 kHz	-14 dB MIN
POTS Delay Distortion	600 Hz to 4 kHz	200 μSec MAX
Longitudinal Balance	100 Hz to 3.4 kHz	-52 dB MIN
ADSL Insertion Loss	32 kHz to 200 kHz	-29 dB MIN
	200 kHz to 2.2 MHz	-55 dB MIN
DC Current		100 mA MAX
Total DC Resistance		50 Ω MAX
For Information - behavior at VDSL frequencies: ADSL Insertion Loss	2.2 MHz to 12 MHz	-40 dB MIN
	12 MHz to 30 MHz	-30 dB MIN

Mechanical

B8046NL

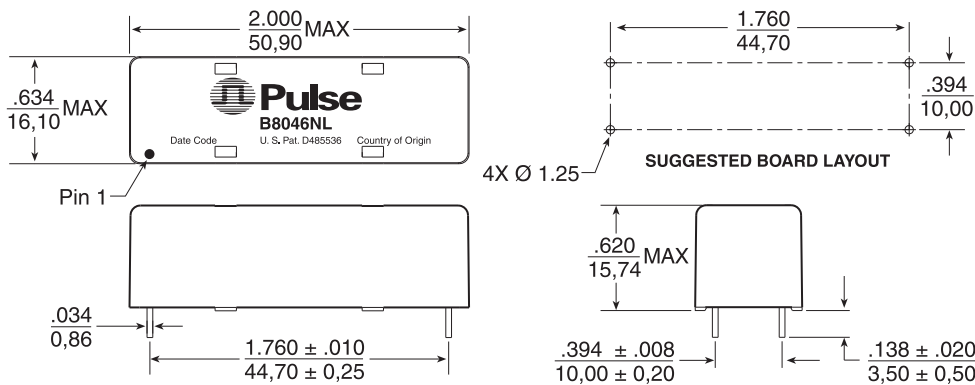

Weight 11 grams
Tray 35/tray
Dimensions: $\frac{\text{Inches}}{\text{mm}}$
 Unless otherwise specified,
 all tolerances are $\pm \frac{.010}{0,25}$

Schematic

B8046NL

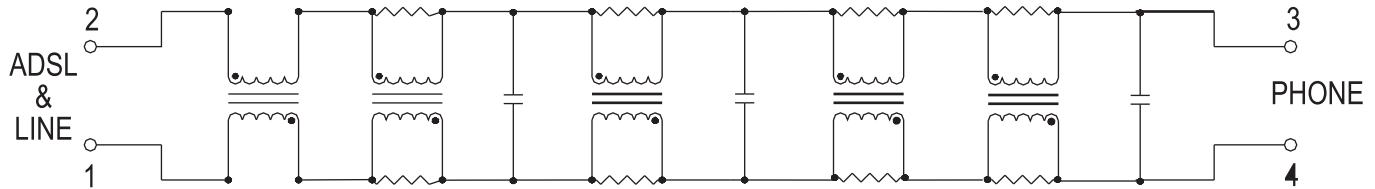

For More Information:

Pulse Worldwide Headquarters
12220 World Trade Dr.
San Diego, CA 92128
U.S.A.
www.pulseeng.com

Tel: 858 674 8100
Fax: 858 674 8262

Pulse Europe
Zeppelinstrasse 15
D-71083 Herrenberg
Germany

Tel: 49 7032 7806 0
Fax: 49 7032 7806 135

Pulse China Headquarters
B402, Shenzhen Academy of
Aerospace Technology Bldg.
10th Kejinan Rd.
High-Tech Zone
Nanshan District
Shenzhen, PR China 518057

Tel: 86 755 33966678
Fax: 86 755 33966700

Pulse North China
Room 2704/2705
Super Ocean Finance
Ctr.
2067 Yan An Rd. West
Shanghai 200336
China

Tel: 86 21 62787060
Fax: 86 2162786973

Pulse South Asia
135 Joo Seng Rd.
#03-02
PM Industrial Bldg.
Singapore 368363

Tel: 65 6287 8998
Fax: 65 6287 8998

Pulse North Asia
3F, No. 198
Zhongyuan Rd.
Zhongli City
Taoyuan County 320
Taiwan R. O. C.

Tel: 886 3 4356768
Fax: 886 3 4356823 (Pulse)
Fax: 886 3 4356820 (FRE)

Performance warranty of products offered on this data sheet is limited to the parameters specified. Data is subject to change without notice. Other brand and product names mentioned herein may be trademarks or registered trademarks of their respective owners.

© Copyright, 2010. Pulse Engineering, Inc. All rights reserved.