



### FEATURES

- Fully specified rail to rail at  $V_{CC} = 2.5\text{ V to }5.5\text{ V}$
- Input common-mode voltage from  $-0.2\text{ V to }V_{CC} + 0.2\text{ V}$
- Low glitch CMOS-/TTL-compatible output stage
- 40 ns propagation delay
- Low power: 1 mW at 2.5 V
- Shutdown pin
- Power supply rejection > 60 dB
- $-40^{\circ}\text{C to }+125^{\circ}\text{C}$  operation

### APPLICATIONS

- High speed instrumentation
- Clock and data signal restoration
- Logic level shifting or translation
- High speed line receivers
- Threshold detection
- Peak and zero-crossing detectors
- High speed trigger circuitry
- Pulse-width modulators
- Current-/voltage-controlled oscillators

### GENERAL DESCRIPTION

The **ADCMP608** is a fast comparator fabricated on XFCB2, an Analog Devices, Inc. proprietary process. This comparator is exceptionally versatile and easy to use. Features include an input range from  $V_{EE} - 0.2\text{ V to }V_{CC} + 0.2\text{ V}$ , low noise, TTL-/CMOS-compatible output drivers, and shutdown inputs. The device offers 40 ns propagation delays driving a 15 pF load with 10 mV overdrive on 500  $\mu\text{A}$  typical supply current.

A flexible power supply scheme allows the device to operate with a single +2.5 V positive supply and a  $-0.2\text{ V to }+2.7\text{ V}$  input signal range up to a +5.5 V positive supply with a  $-0.2\text{ V to }+5.7\text{ V}$  input signal range.

### FUNCTIONAL BLOCK DIAGRAM

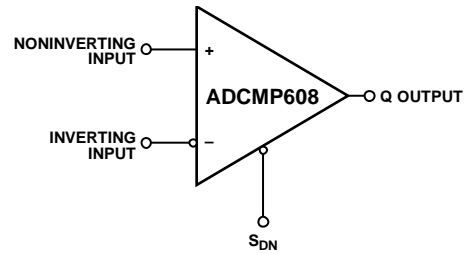

Figure 1.

06769-001

The TTL-/CMOS-compatible output stage is designed to drive up to 15 pF with full rated timing specifications and to degrade in a graceful and linear fashion as additional capacitance is added. The input stage of the comparator offers robust protection against large input overdrive, and the outputs do not phase reverse when the valid input signal range is exceeded.

The **ADCMP608** is available in a tiny 6-lead SC70 package with a single-ended output and a shutdown pin.

# ADCMP608\* PRODUCT PAGE QUICK LINKS

Last Content Update: 02/23/2017

---

## COMPARABLE PARTS

View a parametric search of comparable parts.

## EVALUATION KITS

- ADCMP608 Evaluation Board

## DOCUMENTATION

### Data Sheet

- ADCMP608: Rail-to-Rail, Fast, Low Power 2.5 V to 5.5 V, Single-Supply TTL/CMOS Comparator Data Sheet

## REFERENCE MATERIALS

### Product Selection Guide

- Comparators Product Brochure 2007

## DESIGN RESOURCES

- ADCMP608 Material Declaration
- PCN-PDN Information
- Quality And Reliability
- Symbols and Footprints

## DISCUSSIONS

View all ADCMP608 EngineerZone Discussions.

## SAMPLE AND BUY

Visit the product page to see pricing options.

## TECHNICAL SUPPORT

Submit a technical question or find your regional support number.

## DOCUMENT FEEDBACK

Submit feedback for this data sheet.

---

**TABLE OF CONTENTS**

Features .....	1	Applications Information .....	7
Applications .....	1	Power/Ground Layout and Bypassing .....	7
Functional Block Diagram .....	1	TTL-/CMOS-Compatible Output Stage .....	7
General Description .....	1	Optimizing Performance .....	7
Revision History .....	2	Comparator Propagation Delay Dispersion .....	7
Specifications .....	3	Crossover Bias Point .....	8
Electrical Characteristics .....	3	Minimum Input Slew Rate Requirement .....	8
Absolute Maximum Ratings .....	4	Typical Application Circuits .....	9
Thermal Resistance .....	4	Outline Dimensions .....	10
ESD Caution .....	4	Ordering Guide .....	10
Pin Configuration and Function Descriptions .....	5		
Typical Performance Characteristics .....	6		

**REVISION HISTORY**

<b>11/14—Rev. A to Rev. B</b>	
Changes to Figure 7 and Figure 8 .....	6
<b>6/14—Rev. 0 to Rev. A</b>	
Changes to Temperature Parameter, Table 2 .....	4
Changes to Ordering Guide .....	10
<b>4/07—Revision 0: Initial Version</b>	

## SPECIFICATIONS

## ELECTRICAL CHARACTERISTICS

$V_{CC} = 2.5\text{ V}$ ,  $T_A = -40^\circ\text{C}$  to  $+125^\circ\text{C}$ . Typical values are  $T_A = 25^\circ\text{C}$ , unless otherwise noted.

Table 1.

Parameter	Symbol	Conditions	Min	Typ	Max	Unit
<b>DC INPUT CHARACTERISTICS</b>						
Voltage Range	$V_P, V_N$	$V_{CC} = 2.5\text{ V to }5.5\text{ V}$	-0.2		$V_{CC}$	V
Common-Mode Range		$V_{CC} = 2.5\text{ V to }5.5\text{ V}$	-0.2		$V_{CC}$	V
Differential Voltage		$V_{CC} = 2.5\text{ V to }5.5\text{ V}$			$V_{CC}$	V
Offset Voltage	$V_{OS}$		-5.0	±3	+5.0	mV
Bias Current	$I_P, I_N$		-0.4		+0.4	μA
Offset Current			-1.0		+1.0	μA
Capacitance	$C_P, C_N$			1		pF
Resistance, Differential Mode		-0.5 V to $V_{CC} + 0.5\text{ V}$	200		7000	kΩ
Resistance, Common Mode		-0.5 V to $V_{CC} + 0.5\text{ V}$	100		4000	kΩ
Active Gain	$A_V$			80		dB
Common-Mode Rejection	CMRR	$V_{CC} = 2.5\text{ V}, V_{CM} = -0.2\text{ V to }2.7\text{ V}$ $V_{CC} = 5.5\text{ V}$	45			dB
			45			dB
<b>SHUTDOWN PIN CHARACTERISTICS<sup>1</sup></b>						
$V_{IH}$		Comparator is operating	2.0		$V_{CC}$	V
$V_{IL}$		Shutdown guaranteed	-0.2	+0.4	+0.4	V
$I_{IH}$		$V_{IH} = V_{CC}$	-6		+6	μA
Sleep Time	$t_{SD}$	$I_{CC} < 100\text{ μA}$		300		ns
Wake-Up Time	$t_H$	$V_{PP} = 10\text{ mV}$ , output valid		150		ns
<b>DC OUTPUT CHARACTERISTICS</b>						
Output Voltage High Level	$V_{OH}$	$V_{CC} = 2.5\text{ V to }5.5\text{ V}$ $I_{OH} = 0.8\text{ mA}, V_{CC} = 2.5\text{ V}$	$V_{CC} - 0.4$			V
Output Voltage Low Level	$V_{OL}$	$I_{OL} = 0.8\text{ mA}, V_{CC} = 2.5\text{ V}$			0.4	V
<b>AC PERFORMANCE<sup>2</sup></b>						
Rise Time/Fall Time	$t_R, t_F$	$V_{CC} = 2.5\text{ V to }5.5\text{ V}$ 10% to 90%, $V_{CC} = 2.5\text{ V}$ 10% to 90%, $V_{CC} = 5.5\text{ V}$		25 to 50 45 to 75		ns
Propagation Delay	$t_{PD}$	$V_{OD} = 10\text{ mV}, V_{CC} = 2.5\text{ V}$ $V_{OD} = 50\text{ mV}, V_{CC} = 5.5\text{ V}$		30 to 50 35 to 60		ns
Propagation Delay Skew—Rising to Falling Transition		$V_{CC} = 2.5\text{ V}$ $V_{CC} = 5.5\text{ V}$		4.5 8		ns
Overdrive Dispersion		$10\text{ mV} < V_{OD} < 125\text{ mV}$		12		ns
Common-Mode Dispersion		$-0.2\text{ V} < V_{CM} < V_{CC} + 0.2\text{ V}$		1.5		ns
<b>POWER SUPPLY</b>						
Supply Voltage Range	$V_{CC}$		2.5		5.5	V
Positive Supply Current	$I_{VCC}$	$V_{CC} = 2.5\text{ V}$ $V_{CC} = 5.5\text{ V}$		550 800	800 1300	μA
Power Dissipation	$P_D$	$V_{CC} = 2.5\text{ V}$ $V_{CC} = 5.5\text{ V}$		1.375 4.95	2.0 7.15	mW
Power Supply Rejection Ratio	PSRR	$V_{CC} = 2.5\text{ V to }5.5\text{ V}$	-50			dB
Shutdown Current	$I_{SD}$	$V_{CC} = 2.5\text{ V to }5.5\text{ V}$		250	350	μA

<sup>1</sup> The output will be in a high impedance mode when the device is in shutdown mode. Note that this feature should be used with care since the enable/disable time is much longer than with a true tristate output.

<sup>2</sup>  $V_{IN} = 100\text{ mV}$  square input at 1 MHz,  $V_{CM} = 0\text{ V}$ ,  $C_L = 15\text{ pF}$ ,  $V_{CCI} = 2.5\text{ V}$ , unless otherwise noted.

## ABSOLUTE MAXIMUM RATINGS

Table 2.

Parameter	Rating
Supply Voltages	
Supply Voltage ( $V_{CC}$ to GND)	–0.5 V to +6.0 V
Supply Differential	–6.0 V to +6.0 V
Input Voltages	
Input Voltage	–0.5 V to $V_{CC} + 0.5$ V
Differential Input Voltage	$\pm(V_{CC} + 0.5$ V)
Maximum Input/Output Current	$\pm 50$ mA
Shutdown Control Pin	
Applied Voltage ( $S_{DN}$ to GND)	–0.5 V to $V_{CC} + 0.5$ V
Maximum Input/Output Current	$\pm 50$ mA
Output Current	$\pm 50$ mA
Temperature	
Operating Temperature, Ambient	–40°C to +125°C
Operating Temperature, Junction	150°C
Storage Temperature Range	–65°C to +150°C

Stresses at or above those listed under Absolute Maximum Ratings may cause permanent damage to the product. This is a stress rating only; functional operation of the product at these or any other conditions above those indicated in the operational section of this specification is not implied. Operation beyond the maximum operating conditions for extended periods may affect product reliability.

## THERMAL RESISTANCE

$\theta_{JA}$  is specified for the worst-case conditions, that is, a device soldered in a circuit board for surface-mount packages.

Table 3. Thermal Resistance

Package Type	$\theta_{JA}^1$	Unit
ADCMP608 6-Lead SC70	426	°C/W

<sup>1</sup> Measurement in still air.

## ESD CAUTION



### ESD (electrostatic discharge) sensitive device.

Charged devices and circuit boards can discharge without detection. Although this product features patented or proprietary protection circuitry, damage may occur on devices subjected to high energy ESD. Therefore, proper ESD precautions should be taken to avoid performance degradation or loss of functionality.

## PIN CONFIGURATION AND FUNCTION DESCRIPTIONS

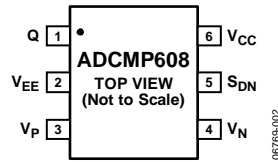

Figure 2. Pin Configuration

Table 4. ADCMP608 Pin Function Descriptions

Pin No.	Mnemonic	Description
1	Q	Noninverting Output. Q is at logic high if the analog voltage at the noninverting input, $V_P$ , is greater than the analog voltage at the inverting input, $V_N$ .
2	$V_{EE}$	Negative Supply Voltage.
3	$V_P$	Noninverting Analog Input.
4	$V_N$	Inverting Analog Input.
5	$S_{DN}$	Shutdown. Drive this pin low to shut down the device.
6	$V_{CC}$	$V_{CC}$ Supply.

TYPICAL PERFORMANCE CHARACTERISTICS

$V_{CC} = 2.5\text{ V}$ ,  $T_A = 25^\circ\text{C}$ , unless otherwise noted.

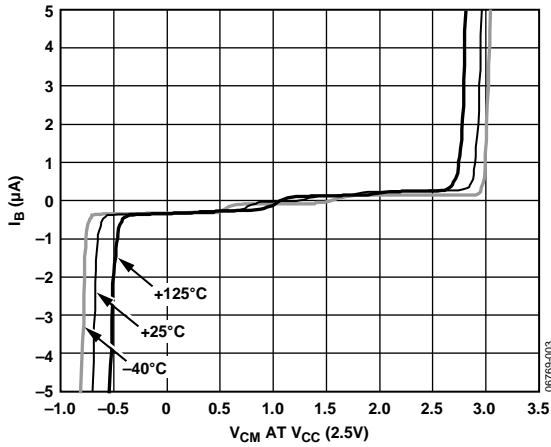

Figure 3. Input Bias Current vs. Input Common-Mode Voltage

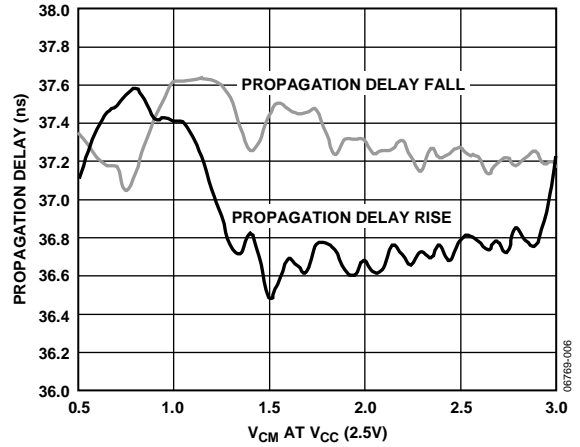

Figure 6. Propagation Delay vs. Input Common-Mode Voltage

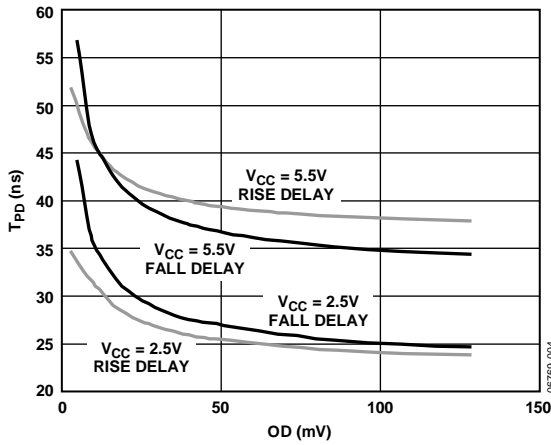

Figure 4. Propagation Delay vs. Input Overdrive at  $V_{CC} = 2.5\text{ V}$  and  $5.5\text{ V}$

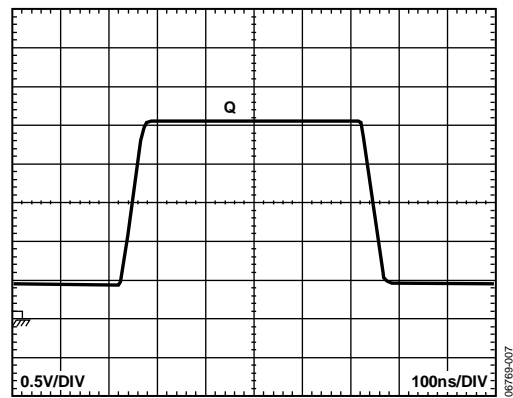

Figure 7. 1 MHz Output Voltage Waveform  $V_{CC} = 2.5\text{ V}$

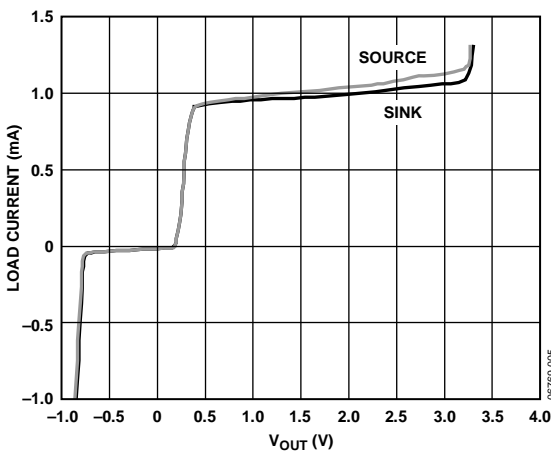

Figure 5. Load Current (mA) vs.  $V_{OH}/V_{OL}$

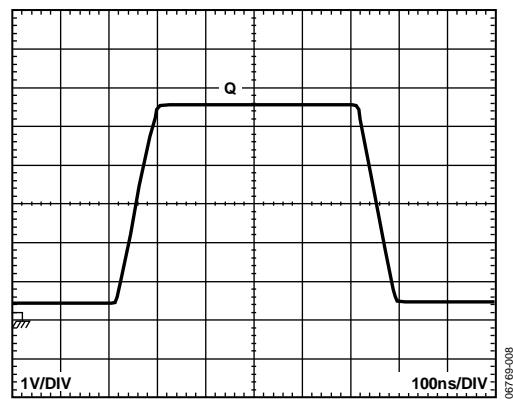

Figure 8. 1 MHz Output Voltage Waveform  $V_{CC} = 5.5\text{ V}$

## APPLICATIONS INFORMATION

### POWER/GROUND LAYOUT AND BYPASSING

The ADCMP608 comparator is a high speed device. Despite the low noise output stage, it is essential to use proper high speed design techniques to achieve the specified performance. Because comparators are uncompensated amplifiers, feedback in any phase relationship is likely to cause oscillations or undesired hysteresis. Of critical importance is the use of low impedance supply planes, particularly the output supply plane ( $V_{CC}$ ) and the ground plane (GND). Individual supply planes are recommended as part of a multilayer board. Providing the lowest inductance return path for switching currents ensures the best possible performance in the target application.

It is also important to adequately bypass the input and output supplies. A 0.1  $\mu\text{F}$  bypass capacitor should be placed as close as possible to the  $V_{CC}$  supply pin. The capacitor should be connected to the GND plane with redundant vias placed to provide a physically short return path for output currents flowing back from ground to the  $V_{CC}$  pin. High frequency bypass capacitors should be carefully selected for minimum inductance and ESR. Parasitic layout inductance should also be strictly controlled to maximize the effectiveness of the bypass at high frequencies.

### TTL-/CMOS-COMPATIBLE OUTPUT STAGE

Specified propagation delay performance can be achieved only by keeping the capacitive load at or below the specified minimums. The output of the ADCMP608 is designed to directly drive one Schottky TTL, or three low power Schottky TTL loads, or the equivalent. For large fan outs, buses, or transmission lines, use an appropriate buffer to maintain the excellent speed and stability of the comparator.

With the rated 15 pF load capacitance applied, more than half of the total device propagation delay is output stage slew time. Because of this, the total propagation delay decreases as  $V_{CC}$  decreases, and instability in the power supply may appear as excess delay dispersion.

Delay is measured to the 50% point for whatever supply is in use; thus, the fastest times are observed with the  $V_{CC}$  supply at 2.5 V, and larger values are observed when driving loads that switch at other levels.

Overdrive and input slew rate dispersions are not significantly affected by output loading and  $V_{CC}$  variations.

The TTL-/CMOS-compatible output stage is shown in the simplified schematic diagram (see Figure 9). Because of its inherent symmetry and generally good behavior, this output stage is readily adaptable for driving various filters and other unusual loads.

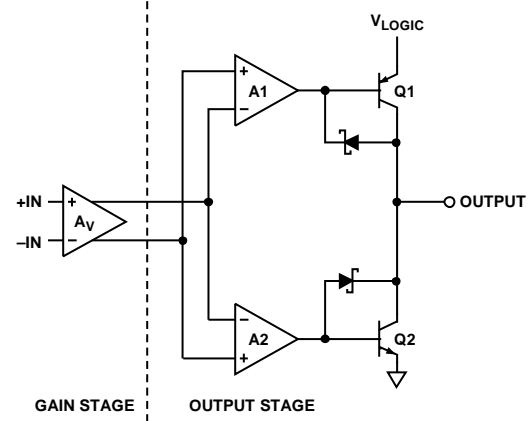

Figure 9. Simplified Schematic Diagram of TTL-/CMOS-Compatible Output Stage

### OPTIMIZING PERFORMANCE

As with any high speed comparator, proper design and layout techniques are essential for obtaining the specified performance. Stray capacitance, inductance, common power and ground impedances, or other layout issues can severely limit performance and can often cause oscillation. The source impedance should be minimized as much as is practicable. High source impedance, in combination with the parasitic input capacitance of the comparator, causes an undesirable degradation in bandwidth at the input, thus degrading the overall response. Higher impedances encourage undesired coupling.

### COMPARATOR PROPAGATION DELAY DISPERSION

The ADCMP608 comparator is designed to reduce propagation delay dispersion over a wide input overdrive range of 10 mV to  $V_{CC} - 1$  V. Propagation delay dispersion is the variation in propagation delay that results from a change in the degree of overdrive or slew rate (how far or how fast the input signal exceeds the switching threshold).

Propagation delay dispersion is a specification that becomes important in high speed, time-critical applications, such as data communication, automatic test and measurement, and instrumentation. It is also important in event-driven applications, such as pulse spectroscopy, nuclear instrumentation, and medical imaging. Dispersion is defined as the variation in propagation delay as the input overdrive conditions are changed (see Figure 10 and Figure 11).

ADCMP608 dispersion is typically  $< 12$  ns as the overdrive varies from 10 mV to 125 mV. This specification applies to both positive and negative signals because the device has very closely matched delays for both positive-going and negative-going inputs, and very low output skews. Remember to add the actual device offset to the overdrive for repeatable dispersion measurements.



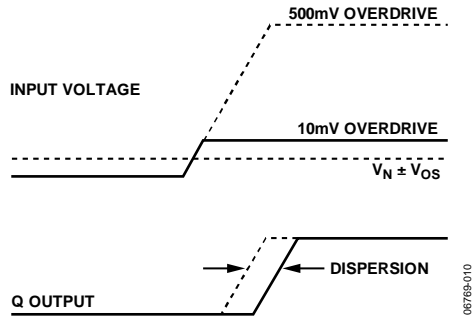

Figure 10. Propagation Delay—Overdrive Dispersion

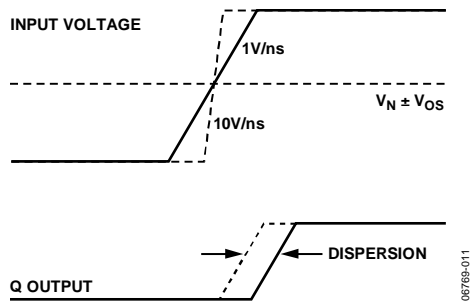

Figure 11. Propagation Delay—Slew Rate Dispersion

**CROSSOVER BIAS POINT**

Rail-to-rail inputs of this type, in both op amps and comparators, have a dual front-end design. Certain devices are active near the  $V_{CC}$  rail and others are active near the  $V_{EE}$  rail. At some predetermined point in the common-mode range, a crossover occurs. At this point, normally  $V_{CC}/2$ , the direction of the bias current reverses and there are changes in measured offset voltages and currents.

The ADCMP608 slightly elaborates on this scheme. Crossover points can be found at approximately 0.8 V and 1.6 V.

**MINIMUM INPUT SLEW RATE REQUIREMENT**

With the rated load capacitance and normal good PC board design practice, as discussed in the Optimizing Performance section, these comparators should be stable at any input slew rate with no hysteresis. Broadband noise from the input stage is observed in place of the violent chattering seen with most other high speed comparators. With additional capacitive loading or poor bypassing, oscillation may be encountered. These oscillations are due to the high gain bandwidth of the comparator in combination with feedback through parasitics in the package and PC board. In many applications, chattering is not harmful.

TYPICAL APPLICATION CIRCUITS

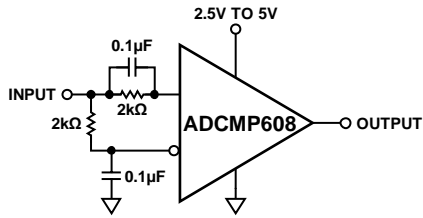

Figure 12. Self-Biased, 50% Slicer

06768-012

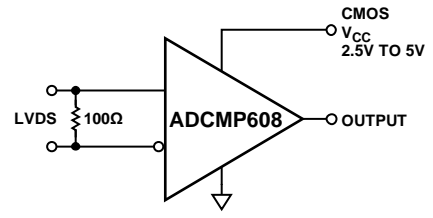
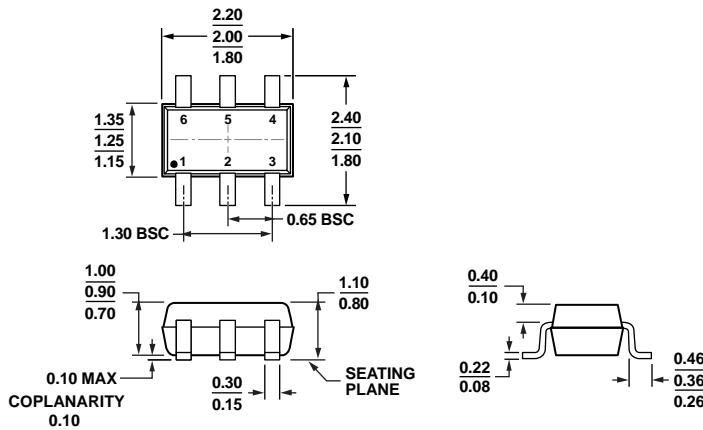

Figure 13. LVDS-to-CMOS Receiver

06768-013

OUTLINE DIMENSIONS



COMPLIANT TO JEDEC STANDARDS MO-203-AB

Figure 14. 6-Lead Thin Shrink Small Outline Transistor Package [SC70] (KS-6)

Dimensions shown in millimeters

ORDERING GUIDE

Model <sup>1</sup>	Temperature Range	Package Description	Package Option	Branding
ADCMP608BKSZ-R2	-40°C to +125°C	6-Lead Thin Shrink Small Outline Transistor Package [SC70]	KS-6	G0U
ADCMP608BKSZ-RL	-40°C to +125°C	6-Lead Thin Shrink Small Outline Transistor Package [SC70]	KS-6	G0U
ADCMP608BKSZ-REEL7	-40°C to +125°C	6-Lead Thin Shrink Small Outline Transistor Package [SC70]	KS-6	G0U
EVAL-ADCMP608BKSZ		Evaluation Board		

<sup>1</sup> Z = RoHS Compliant Part.