

**ON Semiconductor®**<http://onsemi.com>

LC717A00AR

CMOS LSI

Capacitance-Digital-Converter LSI for Electrostatic Capacitive Touch Sensors

Overview

The LC717A00AR is a high-performance, low-cost capacitance-digital-converter LSI for electrostatic capacitive touch sensor, especially focused on usability. It has 8 channels capacitance-sensor input. The built-in logic circuit can detect the state (ON/OFF) of each input and output the result. This makes it ideal for various switch applications. The calibration function is automatically performed by the built-in logic circuit during power activation or whenever there are environmental changes. In addition, since initial settings of parameters, such as gain, are configured, LC717A00AR can operate as stand-alone when the recommended switch pattern is applied. Also, since LC717A00AR has a serial interface compatible with I²C and SPI bus, parameters can be adjusted using external devices whenever necessary. Moreover, outputs of the 8-input capacitance data can be detected and measured as 8-bit data.

Features

- Detection system: Differential capacitance detection (Mutual capacitance type)
- Input capacitance resolution: Can detect capacitance changes in the femto Farad order
- Measurement interval (8 differential inputs): 18ms (Typ) (at initial configuration),
3ms (Typ) (at minimum interval configuration)
- External components for measurement: Not required
- Current consumption: 320μA (Typ) (V_{DD} = 2.8V), 740μA (Typ) (V_{DD} = 5.5V)
- Supply voltage: 2.6V to 5.5V
- Detection operations: Switch
- Packages: VCT28
- Interface: I²C * compatible bus or SPI selectable.

* I²C Bus is a trademark of Philips Corporation.

LC717A00AR

Specifications

Absolute Maximum Ratings at Ta = +25°C

Parameter	Symbol	Ratings (V _{SS} = 0V)	Unit	Remarks
Supply voltage	V _{DD}	-0.3 to +6.5	V	
Input voltage	V _{IN}	-0.3 to V _{DD} +0.3	V	*1
Output voltage	V _{OUT}	-0.3 to V _{DD} +0.3	V	*2
Power dissipation	Pd max	160	mW	Ta = +105°C, Mounted on a substrate *3
Peak output current	I _{OP}	±8	mA	per terminal, 50% Duty ratio *2
Total output current	I _{OA}	±40	mA	Output total value of LSI, 25% Duty ratio
Storage temperature	Tstg	-55 to +125	°C	

*1) Apply to Cin0 to 7, Cref, nRST, SCL, SDA, SA, SCK, SI, nCS, GAIN

*2) Apply to Cdrv, Pout0 to 7, SDA, SO, ERROR, INTOUT

*3) 4-layer glass epoxy board (40×50×0.8t mm)

Stresses exceeding Maximum Ratings may damage the device. Maximum Ratings are stress ratings only. Functional operation above the Recommended Operating Conditions is not implied. Extended exposure to stresses above the Recommended Operating Conditions may affect device reliability.

Recommended Operating Conditions

Parameter	Symbol	Conditions	min	typ	max	Unit	Remarks
Operating supply voltage	V _{DD}		2.6		5.5	V	
Supply ripple + noise	Vpp				±20	mV	*1
Operating temperature	Topr		-40	25	105	°C	

*1) Inserting a high-valued capacitor and a low-valued capacitor in parallel between V_{DD} and V_{SS} is recommended. In this case, the small-valued capacitor should be at least 0.1μF, and is mounted near the LSI.

Electrical Characteristics at V_{SS} = 0V, V_{DD} = 2.6 to 5.5V, Ta = -40 to +105°C

* Unless otherwise specified, the Cdrv drive frequency is f_{CDRV} = 143kHz.

* Not tested at low temperature before shipment.

Parameter	Symbol	Conditions	min	typ	max	Unit	Remarks
Capacitance detection resolution	N				8	bit	
Output noise RMS	N _{RMS}	minimum gain setting			±1.0	LSB	*1 *3
Input offset capacitance adjustment range	Coff _{RANGE}			±8.0		pF	*1 *3
Input offset capacitance adjustment resolution	Coff _{RESO}			8		bit	
Cin offset drift	Cin _{DRIFT}	minimum gain setting			±8	LSB	*1
Cin detection sensitivity	Cin _{SENSE}	minimum gain setting	0.04		0.12	LSB/FF	*2
Cin pin leak current	I _{Cin}	Cin = Hi-Z		±25	±500	nA	
Cin allowable parasitic input capacitance	Cin _{SUB}	Cin against V _{SS}			30	pF	*1 *3
Cdrv drive frequency	f _{CDRV}		100	143	186	kHz	
Cdrv pin leak current	I _{CDRV}	Cdrv = Hi-Z		±25	±500	nA	
nRST minimum pulse width	t _{NRST}		1			μs	*1
Power-on reset time	t _{POR}				20	ms	*1
Power-on reset operation condition: Hold time	t _{POROP}		10			ms	*1
Power-on reset operation condition: Input voltage	V _{POROP}				0.1	V	*1
Power-on reset operation condition: Power supply rise rate	t _{VDD}	0V to V _{DD}	1			V/ms	*1
Pin input voltage	V _{IH}	High input	0.8V _{DD}			V	*1 *4
	V _{IL}	Low input			0.2V _{DD}		
Pin output voltage	V _{OH}	High output (I _{OH} = +3mA)	0.8V _{DD}			V	*5
	V _{OL}	Low output (I _{OL} = -3mA)			0.2V _{DD}		

Continued to the next page.

LC717A00AR

Continued from the previous page.

Parameter	Symbol	Conditions	min	typ	max	Unit	Remarks
SDA pin leak current	$V_{OL} I^2C$	SDA Low output ($I_{OL} = -3mA$)			0.4	V	
Pin leak current	I_{LEAK}				± 1	μA	*6
Current consumption	I_{DD}	When stand-alone configuration and non-touch $V_{DD} = 2.8V$		320	390	μA	*1 *3
		when stand-alone configuration and non-touch $V_{DD} = 5.5V$		740	900		
	I_{STBY}	During Sleep process			1	μA	*3

- *1) Design-guaranteed values (not tested before shipment)
- *2) Measurements conducted using the test mode in the LSI
- *3) $T_a = +25^{\circ}C$
- *4) Apply to nRST, SCL, SDA, SA, SCK, SI, nCS, GAIN
- *5) Apply to Cdrv, Pout0 to 7, SO, ERROR, INTOUT
- *6) Apply to nRST, SCL, SDA, SA, SCK, SI, nCS, GAIN

LC717A00AR

I²C Compatible Bus Timing Characteristics at V_{SS} = 0, V_{DD} = 2.6 to 5.5V, Ta = -40 to +105°C

*Not tested at low temperature before shipment

Parameter	Symbol	Pin Name	Conditions	min	typ	max	Unit	Remarks
SCL clock frequency	f _{SCL}	SCL				400	kHz	
START condition hold time	t _{HD;STA}	SCL SDA		0.6			μs	
SCL clock low period	t _{LOW}	SCL		1.3			μs	
SCL clock high period	t _{HIGH}	SCL		0.6			μs	
Repeated START condition setup time	t _{SU;STA}	SCL SDA		0.6			μs	*1
Data hold time	t _{HD;DAT}	SCL SDA		0		0.9	μs	
Data setup time	t _{SU;DAT}	SCL SDA		100			μs	*1
SDA, SCL rise/fall time	t _r / t _f	SCL SDA				300	μs	*1
STOP condition setup time	t _{SU;STO}	SCL SDA		0.6			μs	
STOP-to-START bus release time	t _{BUF}	SCL SDA		1.3			μs	*1

*1) Design-guaranteed values (not tested before shipment)

SPI Bus Timing Characteristics at V_{SS} = 0, V_{DD} = 2.6 to 5.5V, Ta = -40 to +105°C

*Not tested at low temperature before shipment

Parameter	Symbol	Pin Name	Conditions	min	typ	max	Unit	Remarks
SCK clock frequency	f _{SCK}	SCK				5	MHz	
SCK clock Low time	t _{LOW}	SCK		90			ns	*1
SCK clock High time	t _{HIGH}	SCK		90			ns	*1
Input signal rise/fall time	t _r / t _f	nCS SCK SI				300	ns	*1
nCS setup time	t _{SU;nCS}	nCS SCK		90			ns	*1
SCK clock setup time	t _{SU;SCK}	nCS SCK		90			ns	*1
Data setup time	t _{SU;SI}	SCK SI		20			ns	*1
Data hold time	t _{HD;SI}	SCK SI		30			ns	*1
nCS hold time	t _{HD;nCS}	nCS SCK		90			ns	*1
SCK clock hold time	t _{HD;SCK}	nCS SCK		90			ns	*1
nCS standby pulse width	t _{CPH}	nCS		90			ns	*1
Output high impedance time from nCS	t _{CHZ}	nCS SO				80	ns	*1
Output data determination time	t _v	SCK SO				80	ns	*1
Output data hold time	t _{HD;SO}	SCK SO		0			ns	*1
Output low impedance time from SCK clock	t _{CLZ}	SCK SO		0			ns	*1

*1) Design-guaranteed values (not tested before shipment)

LC717A00AR

Power-on Reset (POR)

When power is turned on, power-on reset is enabled inside the LSI and its state is released after a certain power-on reset time, t_{POR} . Power-on reset operation condition: Power supply rise rate t_{VDD} must be at least 1V/ms.

Since INTOUT pin changes from “High” to “Low” at the same time as the released of power-on reset state, it is possible to verify the t_{POR} externally.

During power-on reset state, Cin, Cref and Pout are unknown.

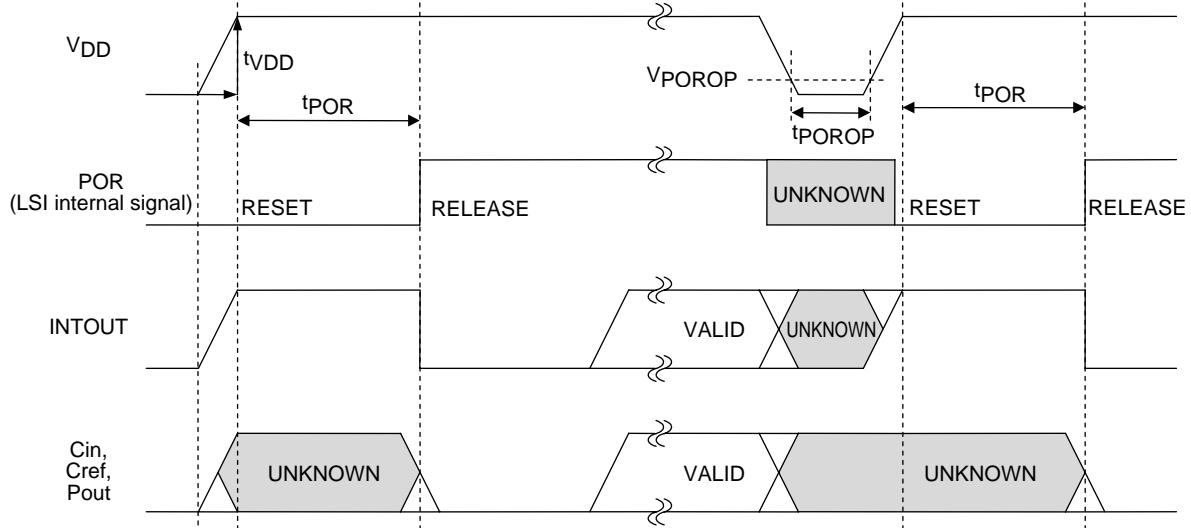

fig.1

I²C Compatible Bus Data Timing

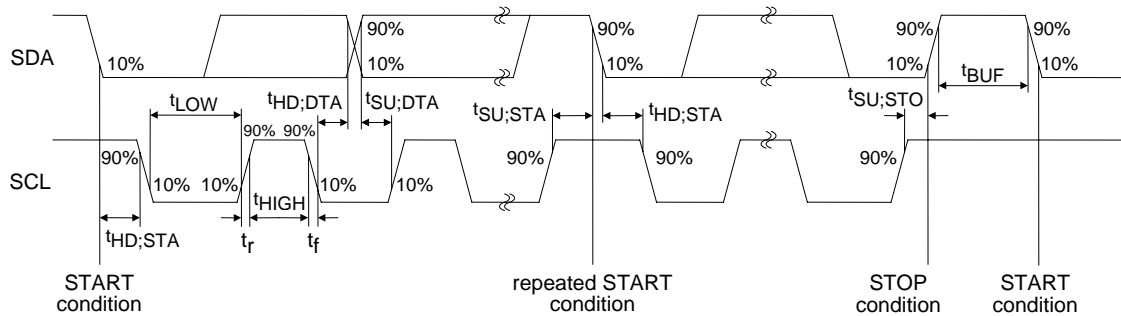

fig.2

I²C Compatible Bus Communication Formats

- Write format (data can be written into sequentially incremented addresses)



fig.3

- Read format (data can be read from sequentially incremented addresses)

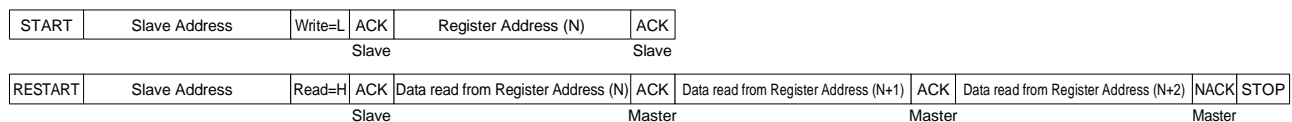

fig.4

LC717A00AR

I²C Compatible Bus Slave Address

Selection of two kinds of addresses is possible through the SA terminal.

SA pin input	7bit Slave Address	Binary Notation	8bit Slave Address
Low	0x16	00101100b (Write)	0x2C
		00101101b (Read)	0x2D
High	0x17	00101110b (Write)	0x2E
		00101111b (Read)	0x2F

SPI Data Timing (SPI Mode 0 / Mode 3)

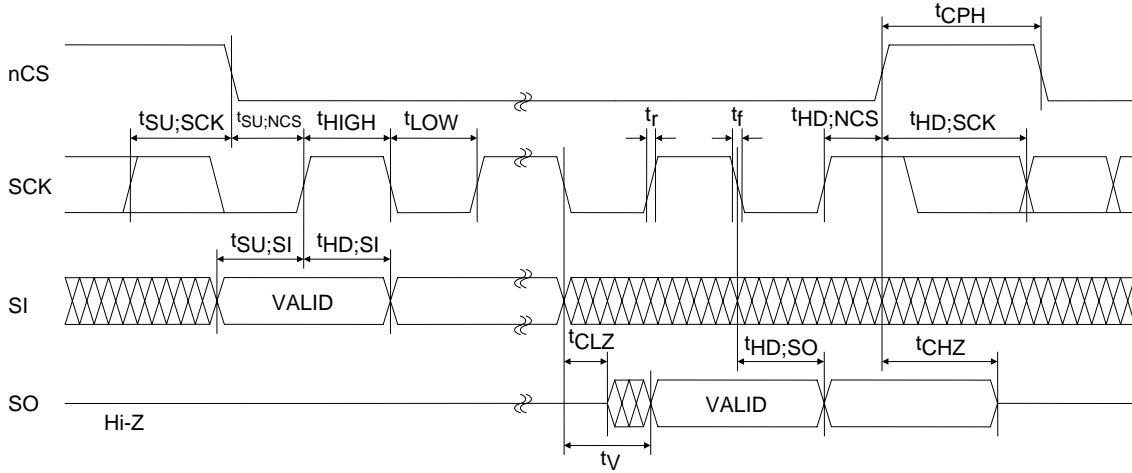

fig.5

SPI Communication Formats (Example of Mode 0)

- Write format (data can be written into sequentially incremented addresses while holding nCS = L)

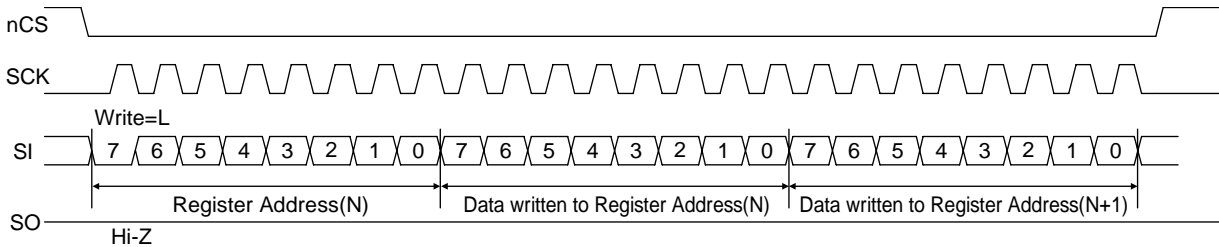

fig.6

- Read format (data can be read from sequentially incremented addresses while holding nCS = L)

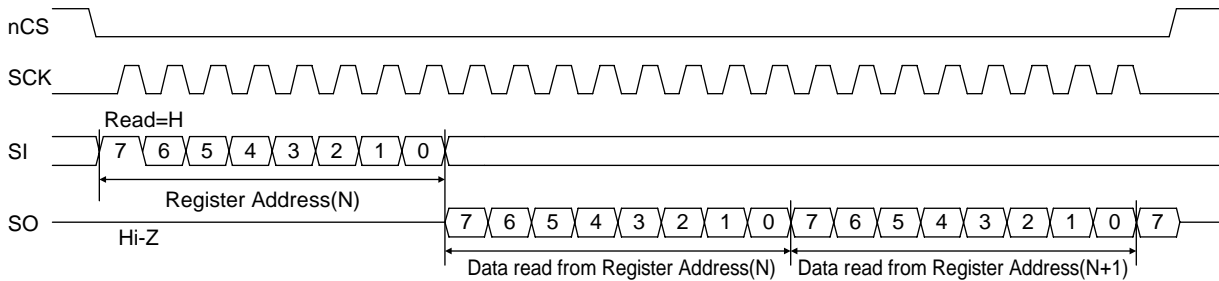

fig.7

LC717A00AR

Package Dimensions [LC717A00AR]

unit : mm (typ)

3357

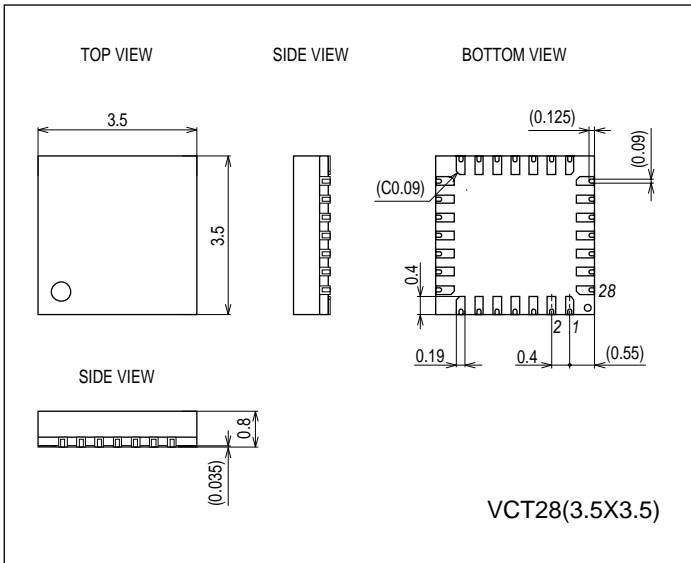

Pin Assignment

Pin No.	Pin Name	Pin No.	Pin Name
1	Cin0	15	Pout4
2	Cin1	16	Pout5
3	Cin2	17	Pout6
4	Cin3	18	Pout7
5	VDD	19	Cref
6	VSS	20	ERROR
7	Cin4	21	Cdrv
8	Cin5	22	INTOUT
9	Cin6	23	GAIN
10	Cin7	24	SCL/SCK
11	Pout0	25	SDA/SI
12	Pout1	26	SA/SO
13	Pout2	27	nCS
14	Pout3	28	nRST

LC717A00AR

Block Diagram

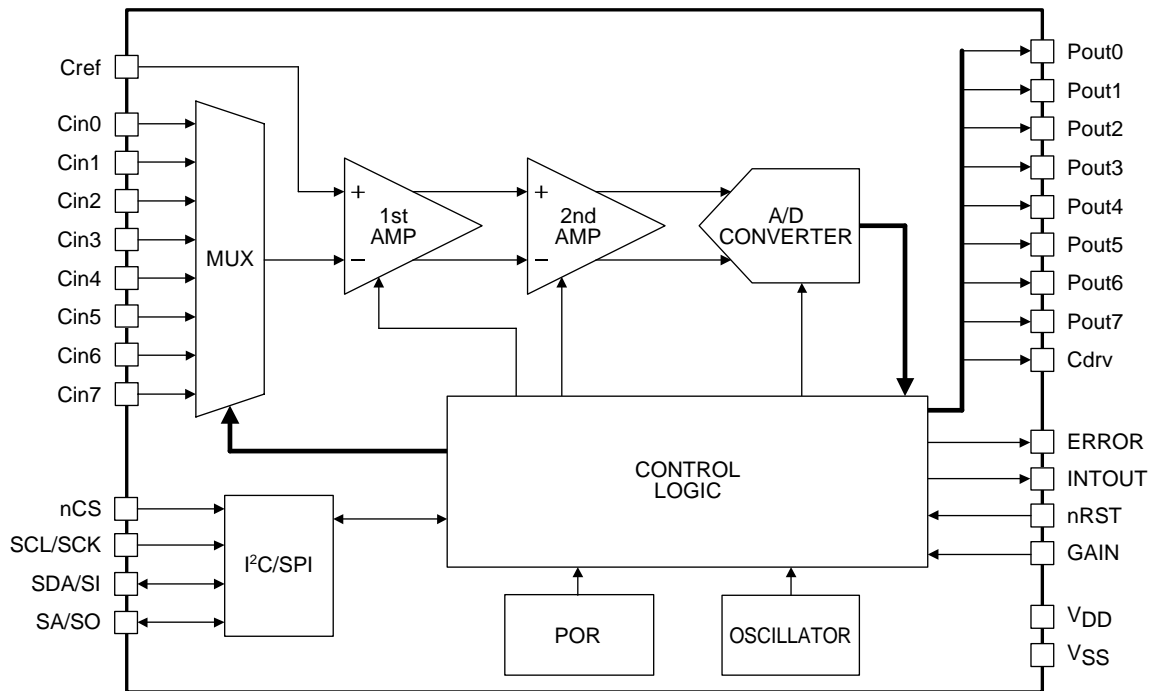

LC717A00AR is capacitance-digital-converter LSI capable of detecting changes in capacitance in the femto Farad order. It consists of an oscillation circuit that generates the system clock, a power-on reset circuit that resets the system when the power is turned on, a multiplexer that selects the input channels, a two-stage amplifier that detects the changes in the capacitance and outputs analog-amplitude values, a A/D converter that converts the analog-amplitude values into digital data, and a control logic that controls the entire chip. Also, it has an I²C compatible bus or SPI that enables serial communication with external devices as necessary.

LC717A00AR

Pin Functions

Pin Name	I/O	Pin Functions	Pin Type
Cin0	I/O	Capacitance sensor input	
Cin1	I/O	Capacitance sensor input	
Cin2	I/O	Capacitance sensor input	
Cin3	I/O	Capacitance sensor input	
Cin4	I/O	Capacitance sensor input	
Cin5	I/O	Capacitance sensor input	
Cin6	I/O	Capacitance sensor input	
Cin7	I/O	Capacitance sensor input	
Cref	I/O	Reference capacitance input	
Pout0	O	Cin0 judgment result output	
Pout1	O	Cin1 judgment result output	
Pout2	O	Cin2 judgment result output	
Pout3	O	Cin3 judgment result output	
Pout4	O	Cin4 judgment result output	
Pout5	O	Cin5 judgment result output	
Pout6	O	Cin6 judgment result output	
Pout7	O	Cin7 judgment result output	
ERROR	O	Error occurrence status output	
Cdrv	O	Output for capacitance sensors drive	
INTOUT	O	Interrupt output	
SCL/SCK	I	Clock input (I ² C) / Clock input (SPI)	
GAIN	I	Selection pin of the initial value of gain of the 2nd-amplifier	
nCS	I	Interface selection / Chip select inverting input (SPI)	
nRST	I	External reset signal inverting input	
SDA/SI	I/O	Data input and output (I ² C) / Data input (SPI)	
SA/SO	I/O	Slave address selection (I ² C) / Data output (SPI)	
V _{DD}		Power supply (2.6V to 5.5V) *1	
V _{SS}		Ground (Earth) *1 *2	

*1) Inserting a high-valued capacitor and a low-valued capacitor in parallel between V_{DD} and V_{SS} is recommended. In this case, the small-valued capacitor should be at least 0.1μF, and is mounted near the LSI.

*2) When V_{SS} terminal is not grounded in battery-powered mobile equipment, detection sensitivity may be degraded.

Details of Pin Functions

●Cin0 to Cin7

These are the capacitance-sensor-input pins. These pins are used by connecting them to the touch switch pattern. Cin and the Cdrv wire patterns should be close to each other. By doing so, Cdrv and Cin patterns are capacitively coupled. Therefore, LSI can detect capacitance change near each pattern as 8bit digital data.

However, if the shape of each pattern or the capacitively coupled value of Cdrv is not appropriate, it may not be able to detect the capacitance change correctly.

In this LSI, there is a two-stage amplifier that detects the changes in the capacitance and outputs analog-amplitude values. Cin0 to Cin7 are connected to the inverting input of the 1st amplifier in the LSI.

During measurement process, channels other than the one being measured are all in “Low” condition.

Leave the unused terminals open.

●Cref

It is the reference-capacitance-input pin. It is used by connecting to the wire pattern like Cin pins or is used by connecting any capacitance between this pin and Cdrv pin.

In this LSI, there is a two-stage amplifier that detects the changes in the capacitance and outputs analog-amplitude values. Cref is connected to the non-inverting input of the 1st amplifier in the LSI.

Due to the parasitic capacitance generated in the wire connections of Cin pins and their patterns, as well as the one generated between the wire patterns of Cin and Cdrv pins, Cref may not detect capacitance change of each Cin pin accurately. In this case, connect an appropriate capacitance between Cref and Cdrv to detect capacitance change accurately.

However, if the difference between the parasitic capacitance of each Cin pin is extremely large, it may not detect capacitance change in each Cin pin correctly.

●Pout0 to Pout7

These are the detection-result-output pins. The capacitance detection results of Cin0 to Cin7 are compared with the threshold of the LSI. The pin outputs a “High” or a “Low” depending on the result.

●ERROR

It is the error-occurrence-status-output pin.

It outputs “Low” during normal operation. If there is a calibration error or a system error, it outputs “High” to indicate that an error occurred.

●Cdrv

It is the output pin for capacitance sensors drive. It outputs the pulse voltage which is needed to detect capacitance at Cin0 to Cin7.

Cdrv and Cin wire patterns should be close to each other so that they are capacitively coupled.

●INTOUT

It is the interrupt-output pin. It outputs “High” when a measurement process is completed.

Connect to a main microcomputer if necessary, and use as interrupt signal.

Leave the terminal open if not in used.

●SCL/SCK

Clock input (I²C) / Clock input (SPI)

It is the clock input pin of the I²C compatible bus or the SPI depending on the mode of operation.

If interface is not to be used, fix the pin to “High”. However, even if interface is not to be used, providing a communication terminal on board is still recommended.

●GAIN

In this LSI, there is a two-stage amplifier that detects the changes in the capacitance and outputs analog-amplitude values. It is the selection pin of the initial value of gain of the 2nd amplifier.

Even if this LSI is used alone, gain setting can still be selected through this terminal. At initialization of the LSI, it is set to 7-times higher than the minimum setting when GAIN pin is “Low”, and is set to 14-times higher than the minimum setting when GAIN pin is “High”.

LC717A00AR

- nCS

Interface selection / Chip-select-inverting input (SPI)

Selection of I²C compatible bus mode or SPI mode is through this terminal. After initialization, the LSI is automatically in I²C compatible bus mode. To continually use I²C compatible bus mode, fix nCS pin to “High”. To switch to SPI mode after LSI initialization, change the nCS input “High” → “Low”. The nCS pin is used as the chip-select-inverting input pin of SPI, and SPI mode is kept until LSI is again initialized.

If interface is not to be used, fix the pin to “High”.

- nRST

It is the external-reset-signal-inverting-input pin. When nRST pin is “Low”, LSI is in the reset state.

Each pin (Cin0 to 7, Cref, Pout,0 to 7, ERROR) is “Hi-Z” during reset state.

- SDA/SI

Data input and output (I²C) / Data input (SPI)

It is the data input and output pin of the I²C compatible bus or the data input pin of the SPI depending on the mode of operation.

If interface is not to be used, fix the pin to “High”. However, even if interface is not to be used, providing a communication terminal on board is still recommended.

- SA/SO

Slave address selection (I²C) / Data output (SPI)

It is the slave address selection pin of the I²C compatible bus or the data output pin of the SPI depending on the mode of operation.

If interface is not to be used, fix the pin to “High”. However, even if interface is not to be used, providing a communication terminal on board is still recommended.

ON Semiconductor and the ON logo are registered trademarks of Semiconductor Components Industries, LLC (SCILLC). SCILLC owns the rights to a number of patents, trademarks, copyrights, trade secrets, and other intellectual property. A listing of SCILLC's product/patent coverage may be accessed at www.onsemi.com/site/pdf/Patent-Marking.pdf. SCILLC reserves the right to make changes without further notice to any products herein. SCILLC makes no warranty, representation or guarantee regarding the suitability of its products for any particular purpose, nor does SCILLC assume any liability arising out of the application or use of any product or circuit, and specifically disclaims any and all liability, including without limitation special, consequential or incidental damages. "Typical" parameters which may be provided in SCILLC data sheets and/or specifications can and do vary in different applications and actual performance may vary over time. All operating parameters, including "Typicals" must be validated for each customer application by customer's technical experts. SCILLC does not convey any license under its patent rights nor the rights of others. SCILLC products are not designed, intended, or authorized for use as components in systems intended for surgical implant into the body, or other applications intended to support or sustain life, or for any other application in which the failure of the SCILLC product could create a situation where personal injury or death may occur. Should Buyer purchase or use SCILLC products for any such unintended or unauthorized application, Buyer shall indemnify and hold SCILLC and its officers, employees, subsidiaries, affiliates, and distributors harmless against all claims, costs, damages, and expenses, and reasonable attorney fees arising out of, directly or indirectly, any claim of personal injury or death associated with such unintended or unauthorized use, even if such claim alleges that SCILLC was negligent regarding the design or manufacture of the part. SCILLC is an Equal Opportunity/Affirmative Action Employer. This literature is subject to all applicable copyright laws and is not for resale in any manner.