

PRODUCT CATALOG

JS Popper by Mueller Electric

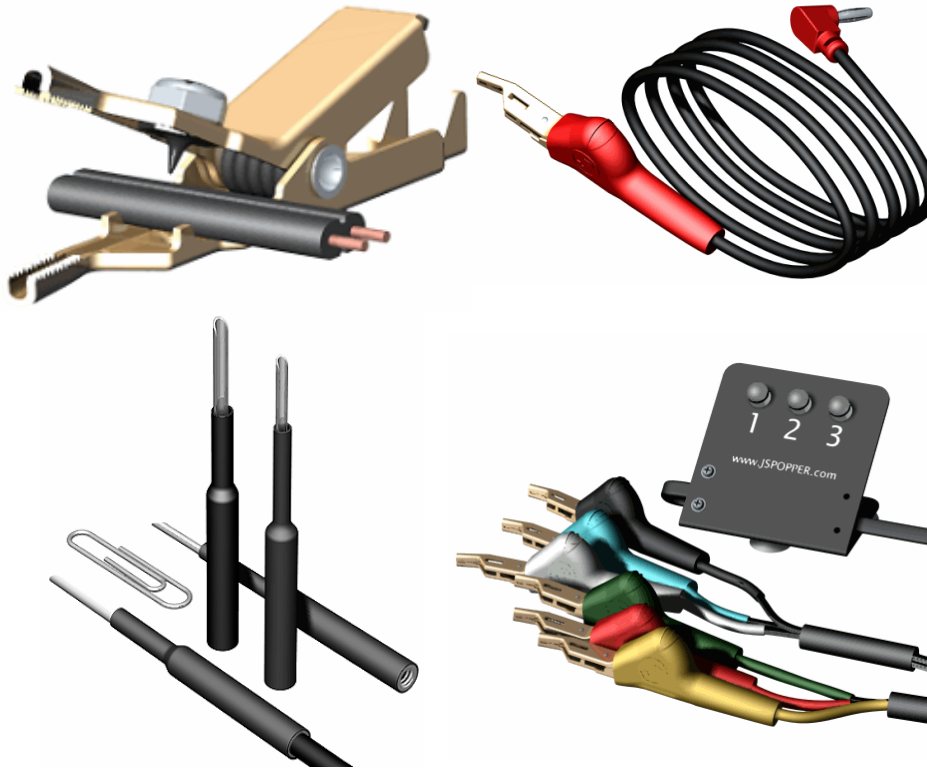

Our full line of JS Popper test products enables you to monitor circuits without taking them offline

Complete Line of Test Products

Insulation Piercing Test Clips for Telecommunications, Automotive, and General Purpose Use

Insulating Boots for Test Clips

Back Probes

Test Lead Assemblies, featuring Insulation Piercing Test Clips & Back Probes

OEM Special Test Lead Assemblies

Specialty Automotive Test Assemblies

To see even more clips and test leads, see our standard catalog or visit our web site



WWW.MUELLERELECTRIC.COM

216-771-5225 phone

800-955-2629 toll free

216-771-3068 fax

1583 East 31st Street
Cleveland, Ohio, 44114

Test Clips

With (and without) Insulation-Piercing

We manufacture electric test clips with or without wire penetrating devices. We offer three insulation-piercing options, illustrated below.

You can see related products, on the following pages. Please visit www.muellerelectric.com to learn more about our products and services.

Single Spike



For heavy wire.

NEW!

24 GAGE

Row-of-Points

25X actual size

All test clips are made of corrosion resistant nickel-silver alloy

Bed-of-Nails

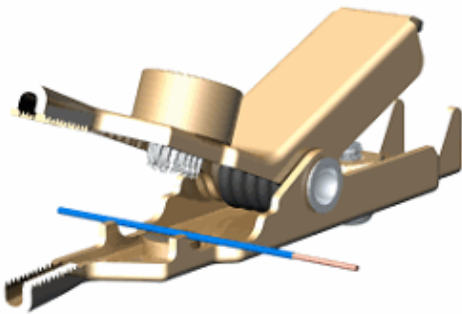

A small bed of insulation-piercing nails is positioned in the upper jaw of the clip. As many as 7 points reach the conductor with each connection. Traditionally used for light wire. Shown with 24 gauge wire.

Row-of-Points: offers more positive connection, and is less intrusive.

Precision hardened stainless steel points on the lower jaw of the clip penetrate insulation to provide a low resistance, low corrosion path to the connection point.

Shown with 24 gauge; designed for a range of gauges.

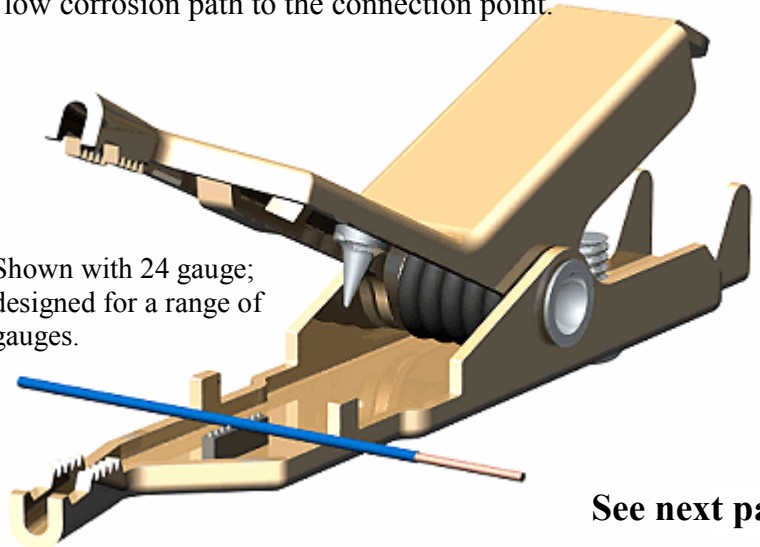

See next page...

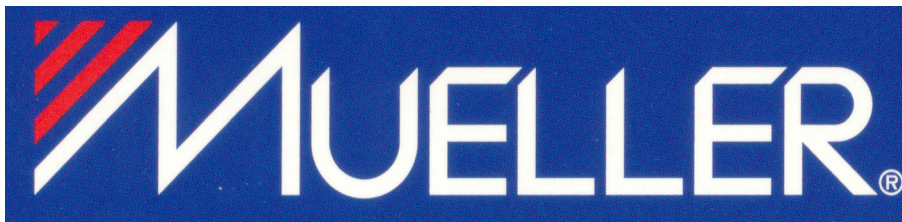

www.muellerelectric.com

216-771-5225 phone

800-955-2629 toll free

216-771-3068 fax

1583 East 31st Street
Cleveland, Ohio, 44114

This clip for telecom

Kinder to copper!

Less risk of galvanic corrosion

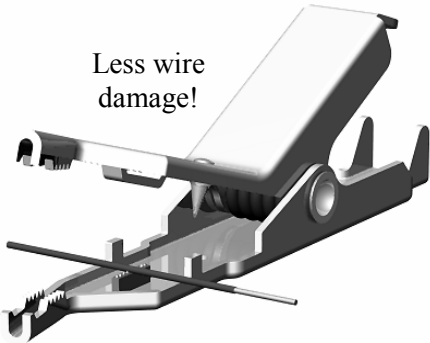

Less wire damage!

JP-1 Test Clip

Row-of-Points.
Single spike.
Angled nose.
66mm (2.6") long.

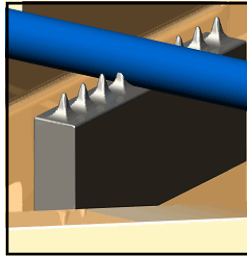

Fewer holes.
Fewer shiners.
Fewer wire breaks.

Less intrusive than bed-of-nails!

For telecommunications wire 19 thru 26 gauge. Two points hug, but do not penetrate, the conductor while penetrating the insulation. The points are hardened stainless steel for durability and protection from rust. Use only with JP-8681-* insulating boot to ensure full clip closure.

JS Popper by Mueller Electric

This clip for automotive and general purpose

10-in-1 Automotive Test Clip

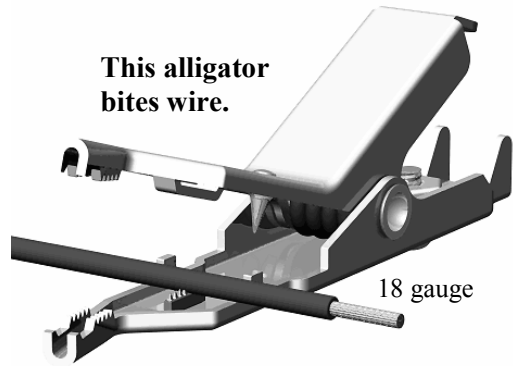

This alligator bites wire.

18 gauge

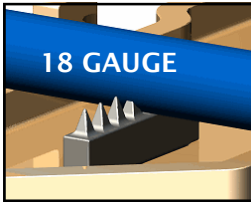

18 GAUGE

Penetrates

- ✓12 gauge
- ✓14 gauge
- ✓16 gauge
- ✓18 gauge
- ✓20 gauge
- ✓22 gauge
- ✓24 gauge
- ✓26 gauge
- ✓10 gauge with the single spike option

JP-2 Test Clip

Row-of-Points.
Single spike.
Angled nose.
extra strong spring.
66mm (2.6") long.



www.muellerelectric.com
216-771-5225 phone
800-955-2629 toll free
216-771-3068 fax
1583 East 31st Street
Cleveland, Ohio, 44114

All telecommunications clips are made of nickel-silver solder friendly, low electrical resistance, corrosion resistant

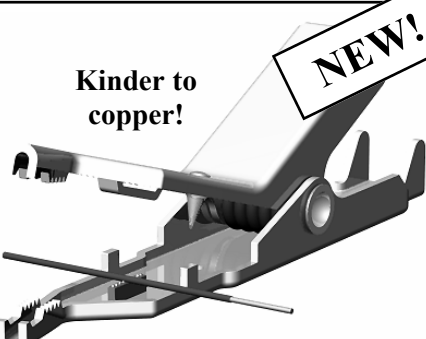

JP-1 Test Clip
For telecom.
Fewer wire breaks.
Better than "bed-of-nails".
See previous page for details.

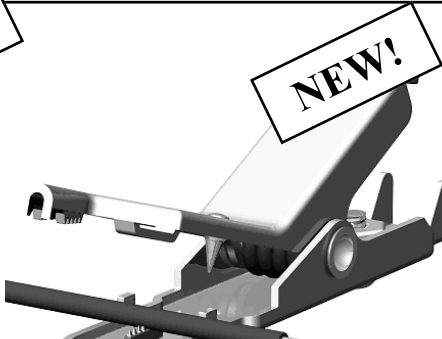

JP-2 Test Clip
Automotive and general purpose.
See previous page for details.



JP-8783 Test Clip
Bed-of-Nails.
Single spike.
Angled nose.
66mm (2.6") long.



JP-8078 Test Clip
Single spike.
Angled nose.
60mm (2.4") long.

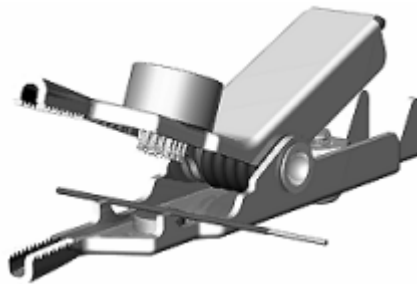

JP-25182 Test Clip
Bed-of-Nails.
Angled nose.
60mm (2.4") long.



JP-8099 Test Clip
Single spike.
Angled nose.
60mm (2.4") long.



JP-33699 Test Clip
JP-33699-N (no insulation piercing)
Single spike
Straight nose
66mm (2.6") long



JP-33674 Test Clip
Single spike
Bed-of-Nails
Straight nose
66mm (2.6") long

Any clip is available without insulation piercing.



JP-8681-* Insulating Boot
Eleven colors.
For all clips on this page.



www.muellerelectric.com

216-771-5225 phone
800-955-2629 toll free
216-771-3068 fax
1583 East 31st Street
Cleveland, Ohio, 44114

Options

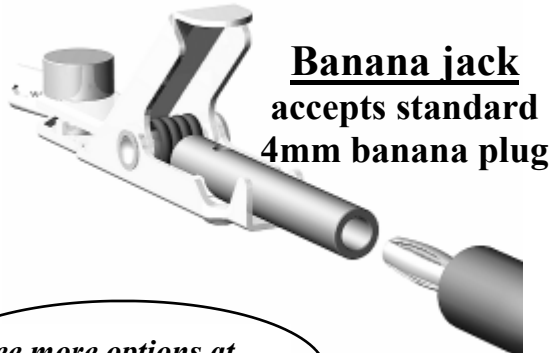

Banana jack
accepts standard
4mm banana plug



Threaded jack
accepts "ice pick"
8-32 threaded style probe

See more options at
www.muellerelectric.com



**Connection
Hardware Options**

- Factory installed
- Loose hardware
- Without hardware

For your application...

JP-33095 Bed-of-Nails

- For penetrating, gripping, or electrical contact - or all three. Approximately 18 hardened steel pins are soldered within a brass holder. The holder has 12-24 threads for attachment to your test equipment.
- Approximately 5.7mm (.226") high.
- Head diameter approx 6.9mm (.270").
- Also sold as "Cable Clip Assembly"

More Test Clips

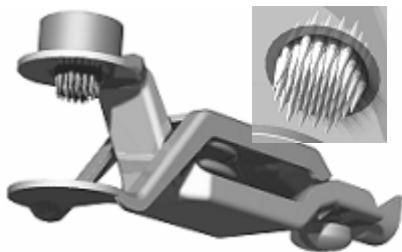

JP-5869-B Test Clip
Formerly JP-15066-B
Bed-of-Nails
60mm (2.4") long



JP-5869-C Test Clip
Formerly JP-15066-C
Circle-of-Points
For heavier wire
60mm (2.4") long



JP-6780 Test Clip
25.4mm (1.0") long
JP-6278 Test Clip
(same as above with 1mm diameter pin, not shown)

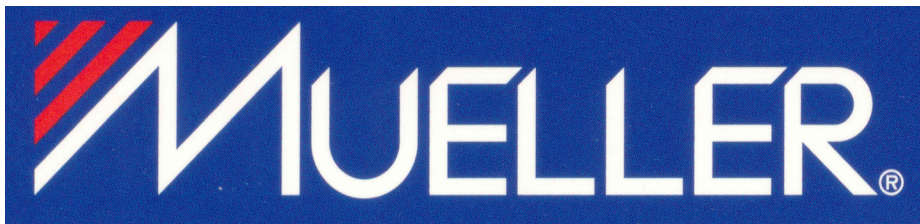

www.muellerelectric.com
216-771-5225 phone
800-955-2629 toll free
216-771-3068 fax
1583 East 31st Street
Cleveland, Ohio, 44114

Test Leads & Accessories

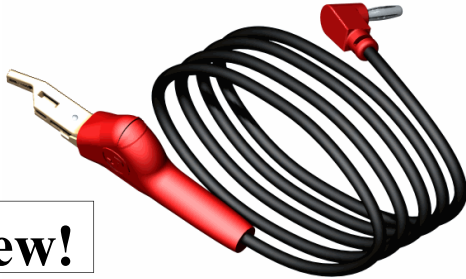

New!

JP-4602-* Test Lead

Standard 4mm banana plug on one end, JP-2 test clip on the other end. 18 gauge wire approx 127cm (50") long. (Cord does not assume a coil shape.) **JP-32890-* test lead** is same as above, with JP-8783 test clip for telecom.

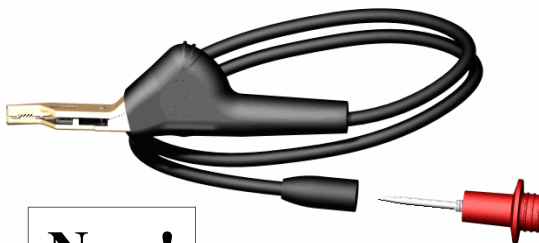

New!

JP-4702-* Test Lead

Friction gripper on one end grips point on "ice pick" style probe. JP-2 test clip on the other end. 18 gauge wire is approx 48cm (19") long. (Cord does not assume a coil shape.)

JP-6095-* test lead is same as above, with JP-8783 test clip for telecom.

JP-6491 Bed-of-Nails Test Pick

For wire penetration with less risk of finger puncture. The "point detail" (JP-NPTP) can be removed and reversed for safe storage, or to access its opposite end.

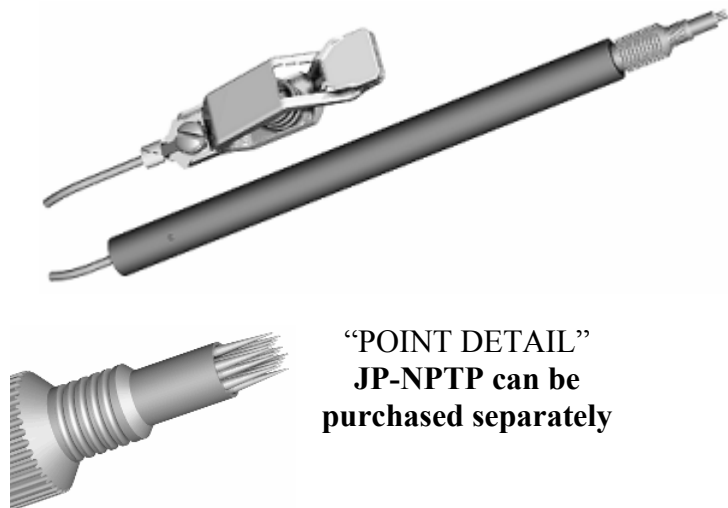

"POINT DETAIL"
JP-NPTP can be purchased separately



www.muellerelectric.com

216-771-5225 phone

800-955-2629 toll free

216-771-3068 fax

1583 East 31st Street
Cleveland, Ohio, 44114

Automotive Test Leads & Accessories



JP-15094 One-Piece Plastic Case

Protects your test accessories.

Inside dimensions: 25.4cm x 10.8cm x 3.8cm
(10" x 4.24" x 1.5")

JP-7095V Scope Lead Kit

Reaches Engine Compartment

- BNC connector on one end of a 129" lead. (3.3 meters)
- Grounding clip and banana plug on opposite end.
- Banana plug accepts:
 - JP-2 Test Clip.
 - Large backprobe.
 - Small backprobe.

(Backprobe tools also sold separately.)

- X1 attenuation only.
- Non-tunable.
- Tough one-piece case.

JP-2696 Scope Lead

BNC connector on one end of 129" lead. JP-2 test clip and grounding clip permanent on other end. No case.

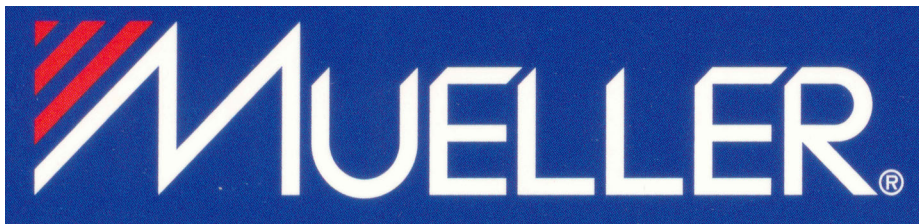

www.muellerelectric.com

216-771-5225 phone

800-955-2629 toll free

216-771-3068 fax

1583 East 31st Street
Cleveland, Ohio, 44114

For transmission diagnosis

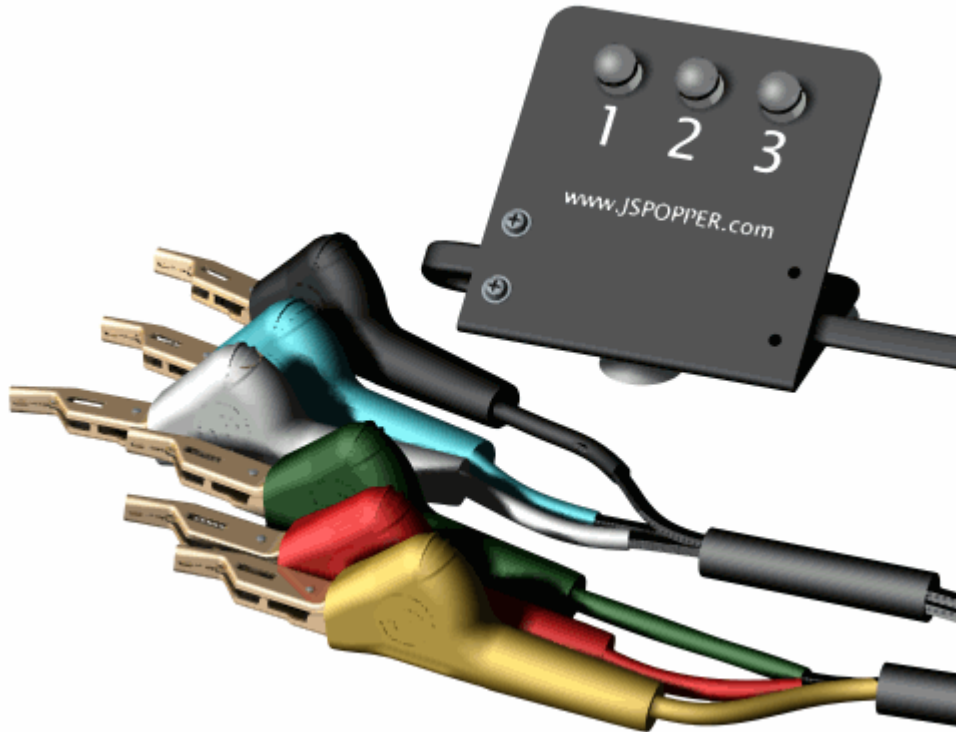

JP-32695 Automatic Transmission Shift Monitor

With these extras

- Tough cord & insulation piercing test clips (JP-2 Clips)
- Slides to minimize entanglement
- Numbered LEDs
- Color coded insulators
- Improved strain relief
- Hook-up instructions are included - ATRA* usage instructions are also available

* Automatic Transmission Rebuilders Association

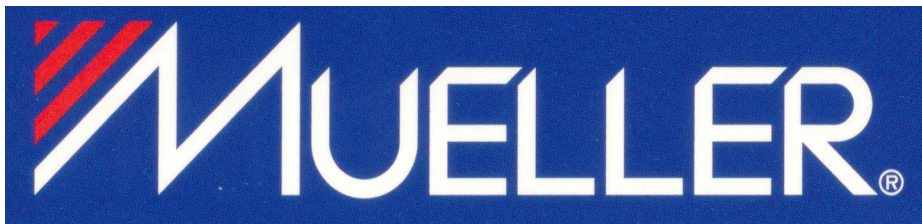

www.muellerelectric.com

216-771-5225 phone

800-955-2629 toll free

216-771-3068 fax

1583 East 31st Street
Cleveland, Ohio, 44114

Do you backprobe?

Use the non-invasive tool designed for the job.

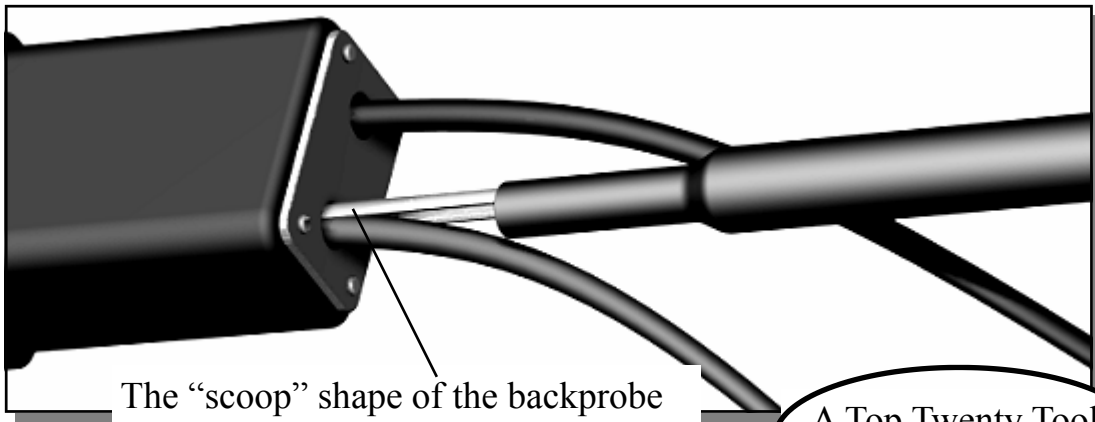

The "scoop" shape of the backprobe allows it to slide along the wire into the back of the test equipment.

A Top Twenty Tool
-*Motor Magazine*

Two sizes of "scoop"
Features copper alloy

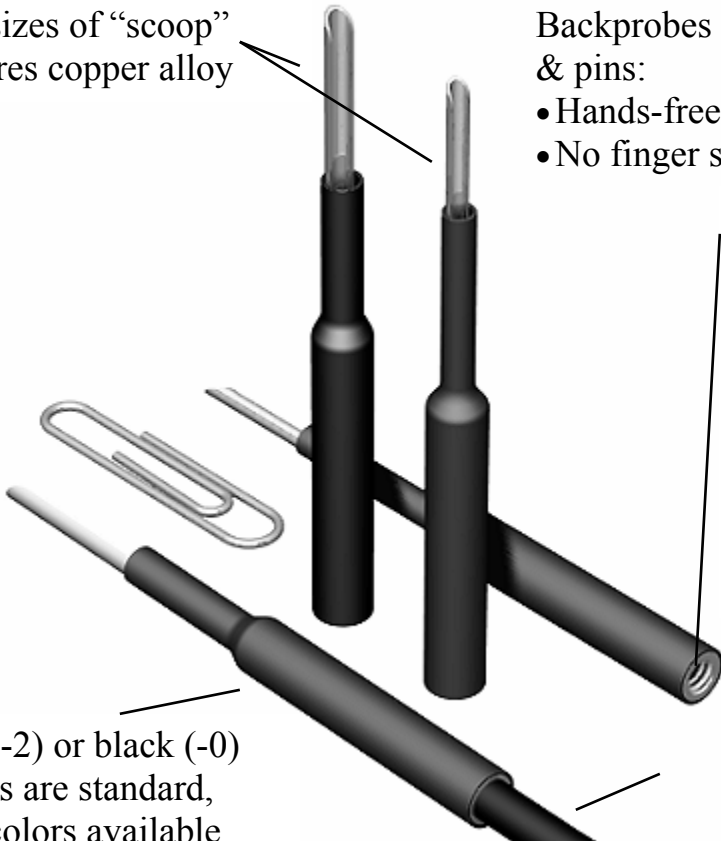

Backprobes are superior to picks & pins:

- Hands-free measurements
- No finger stabbing

Threaded barrel: JP-491-* (small scoop), JP-591-* (large scoop) accepts most "ice pick" style probes with 8-32 threads. Smooth barrel (not shown): JP-30094-* (small scoop), JP-30194-* (large scoop) accepts a standard 4mm banana plug.

*Red (-2) or black (-0) handles are standard, other colors available

Available on cord with standard 4mm banana plug or our unique friction gripper on the opposite end. See later page for description.

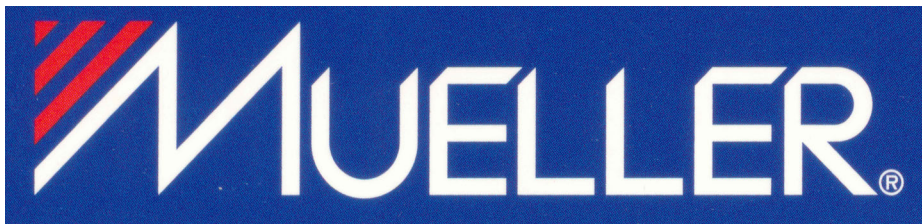

www.muellerelectric.com

216-771-5225 phone
800-955-2629 toll free

216-771-3068 fax
1583 East 31st Street
Cleveland, Ohio, 44114

Cord Sets

Custom made for OEM use.

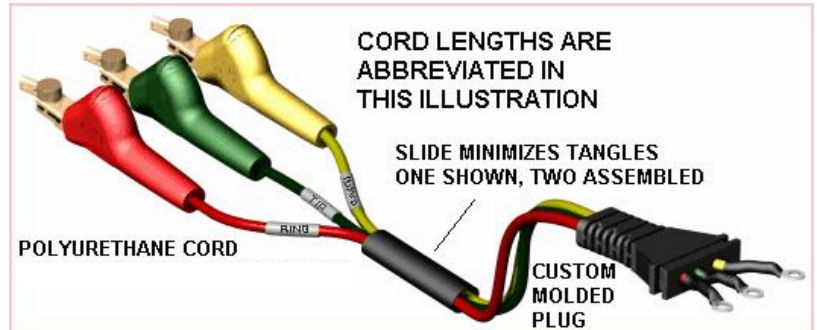
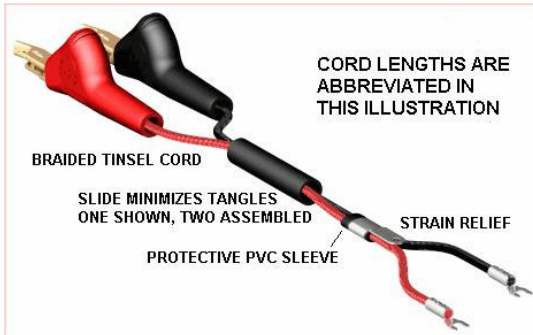

See www.muellerelectric.com for further examples of the value added assemblies we can make for your OEM application. Below are examples of some elements which can be incorporated.

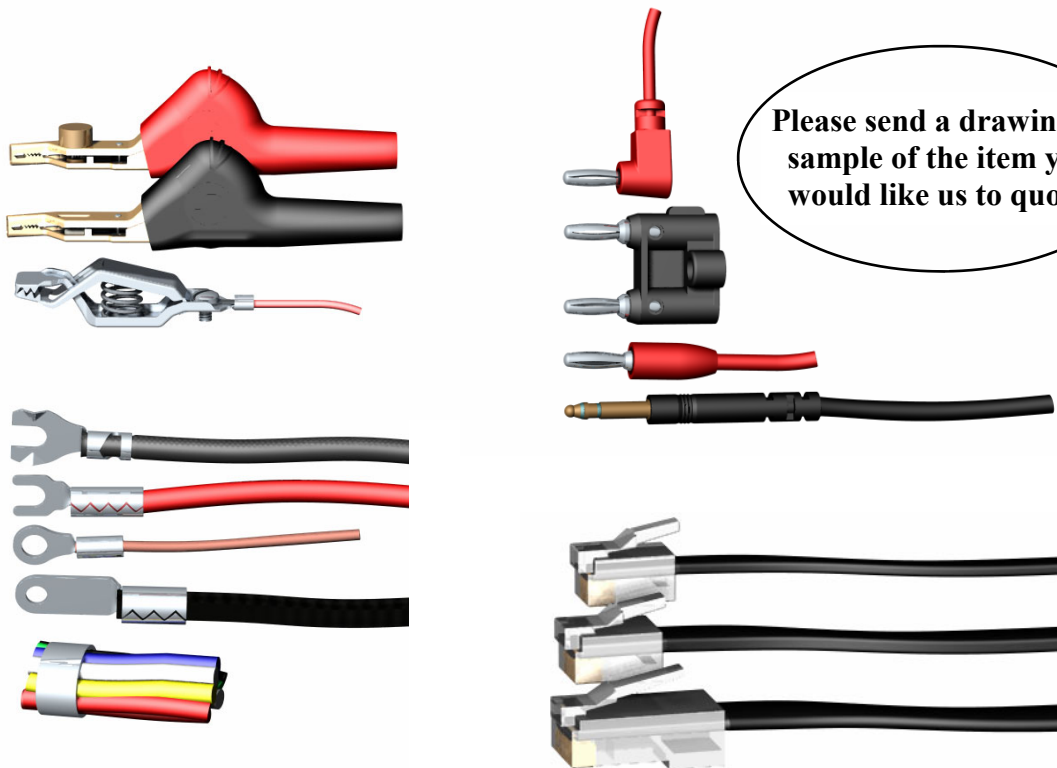

www.muellerelectric.com

216-771-5225 phone

800-955-2629 toll free

216-771-3068 fax

1583 East 31st Street
Cleveland, Ohio, 44114

Selecting Test Clips & Insulating Boots

Clip Part Number	Connection Hardware	Banana Jack*	Threaded Jack*	Clip Part Number	Connection Hardware	Banana Jack*	Threaded Jack*
JP-1	Factory assembled			JP-33699	Factory assembled		
JP-1-L	Loose, bulk packed			JP-33699-L	Loose, bulk packed		
JP-1-N	None provided			JP-33699-N	None provided		
JP-1-J		Yes		JP-33699-J		Yes	
JP-1-TJ			Yes	JP-33699-TJ			Yes
JP-2 NEW!				JP-8078			
JP-2	Factory assembled			JP-8078	Factory assembled		
JP-2-L	Loose, bulk packed			JP-8078-L	Loose, bulk packed		
JP-2-N	None provided			JP-8078-N	None provided		
JP-2-J Clip		Yes		JP-8078-J		Yes	
JP-2-TJ Clip			Yes	JP-8078-TJ			Yes
JP-25182				JP-8099			
JP-25182	Factory assembled			JP-8099	Factory assembled		
JP-25182-L	Loose, bulk packed			JP-8099-L	Loose, bulk packed		
JP-25182-N	None provided			JP-8099-N	None provided		
JP-25182-J		Yes		JP-8099-J		Yes	
JP-25182-TJ			Yes	JP-8099-TJ			Yes
JP-33674				JP-8783			
JP-33674	Factory assembled			JP-8783	Factory assembled		
JP-33674-L	Loose, bulk packed			JP-8783-L	Loose, bulk packed		
JP-33674-N	None provided			JP-8783-N	None provided		
JP-33674-J		Yes		JP-8783-J		Yes	
JP-33674-TJ			Yes	JP-8783-TJ			Yes

Regular

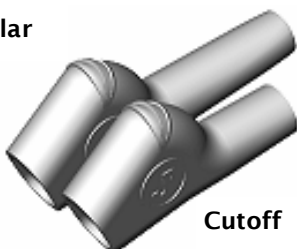

Cutoff

INSULATING BOOTS

The standard **JP-8681-* Insulating Boot** is available in: **Black-0, Brown-1, Red-2, Orange-3, Yellow-4, Green-5, Light Green-L5, Blue-6, Violet-7, Grey-8, White-9, Wine-A**

*To add insulators to clips with jacks use **JP-8681-C* Cutoff Boot**
To add a preassembled boot to any clip, just add -* color, or -C*
 Example: JP-8783-N-1: 8783 clip, no hardware, brown boot

Selecting Test Clips and Insulating Boots Cont'd.

Item	Connection Hardware	Banana Jack	Threaded Jack
JP-5869-B Clip with Bed of Nails	Factory assembled		
JP-5869-B-J Clip w/ Banana Jack		Yes	
JP-5869-B-TJ Clip w/ Threaded Jack			Yes
JP-5869-C Clip with Circle of Nails	Factory assembled		
JP-5869-C-J Clip w/ Banana Jack		Yes	
JP-5869-C-TJ Clip w/ Threaded Jack			Yes
BU-29-* Insulator for JP-5869-B,C Clips, specify color			
JP-6278 Test Clip	1 mm diameter pin included		
JP-6780 Test Clip	None, Solder Connect		
No insulating boot available for the JP-6278 & JP-6780 clips			

Selecting Backprobes

Item	Banana Jack for std 4mm plug (plain or shielded)	Threaded Jack (8-32 thds) for threaded style probe	Small Diameter Scoop OD approx 2.4mm (3/32") ID approx 2.0mm (5/64")	Large Diameter Scoop OD approx 3.2mm (1/8") ID approx 2.4mm (3/32")
JP-491-* Small Backprobe	Yes		Yes	
JP-591-* Large Backprobe	Yes			Yes
JP-30094-* Small Backprobe		Yes	Yes	
JP-30194-* Large Backprobe		Yes		Yes

- Standard Colors, Black -0, Red-2
 See next page for Backprobes preassembled on test leads



www.muellerelectric.com

216-771-5225 phone
800-955-2629 toll free

216-771-3068 fax
1583 East 31st Street
Cleveland, Ohio, 44114

Selecting Backprobes on Test Leads

Item	Length	Gage	One End	Other End includes Scoop Backprobe
JP-26494-2 Test Lead Red	Approx 50.8 cm (20")	18 AWG	Friction gripper	JP-29491-2 Small Red Backprobe
JP-26494-0 Test Lead Black	Approx 50.8 cm (20")	18 AWG	Friction gripper	JP-29491-0 Small Black Backprobe
JP-26594-2 Test Lead Red	Approx 50.8 cm (20")	18 AWG	Friction gripper	JP-29591-2 Large Red Backprobe
JP-26594-0 Test Lead Black	Approx 50.8 cm (20")	18 AWG	Friction gripper	JP-29591-0 Large Black Backprobe

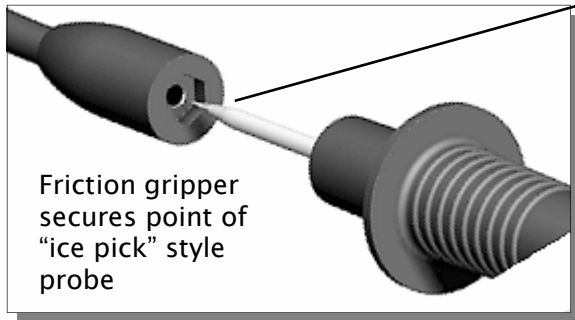

Do you make test equipment?
We offer custom OEM cordsets to your specifications.

JP-29491-2 Test Lead Red	Approx 122 cm (48")	18 AWG	Right angle banana plug	JP-491-2 Small Backprobe Red
JP-29491-0 Test Lead Black	Approx 122 cm (48")	18 AWG	Right angle banana plug	JP-491-0 Small Backprobe Black
JP-29591-2 Test Lead Red	Approx 122 cm (48")	18 AWG	Right angle banana plug	JP-591-2 Large Backprobe Red
JP-29591-0 Test Lead Black	Approx 122 cm (48")	18 AWG	Right angle banana plug	JP-591-0 Large Backprobe Black

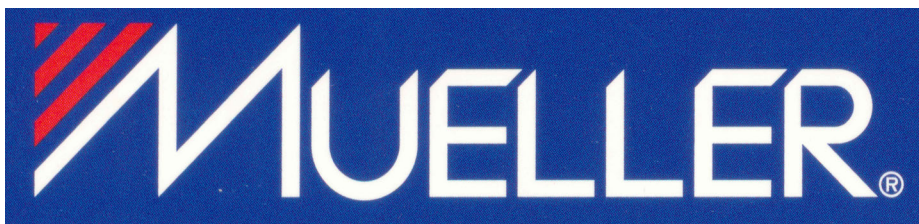

www.muellerelectric.com

216-771-5225 phone

800-955-2629 toll free

216-771-3068 fax

1583 East 31st Street
Cleveland, Ohio, 44114



JS Popper by Mueller Electric

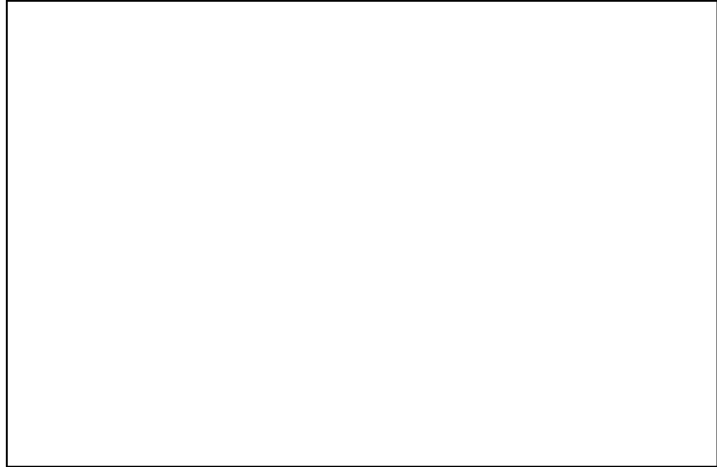

These products and the full line of Mueller Electric Clips, Test Leads and Test Accessory products are available at your nearest distributor



WWW.MUELLERELECTRIC.COM

To see even more clips & test leads, see our standard catalog or visit our website

216-771-5225 phone
800-955-2629 toll free
216-771-3068 fax
1583 East 31st Street
Cleveland, Ohio, 44114